



Dental Group

PRODUCT CATALOGUE

2026



ENGLISH

INTELLIGENT
PROSTHETIC
DENTISTRY

scan Logiq®

THE LOGIC OF SIMPLICITY

ScanLogiq® is a comprehensive solution designed to digitise full-arch restorations with high precision – without requiring additional equipment. The system combines the physical component ScanLogiq® with the online platform AssistLogiq®, guiding the clinician from intraoral scanning to a validated STL file ready for any CAD/CAM software.

Its geometry optimises scan capture through Scan Flag iQs, while real-time automated validation reduces operator dependency and minimises stitching errors in extended scans. Compatible with major transepithelial connections, ScanLogiq® delivers a predictable, repeatable and efficient digital workflow in complex rehabilitations.

SYSTEM



SCAN FLAG iQ



DATA SETS

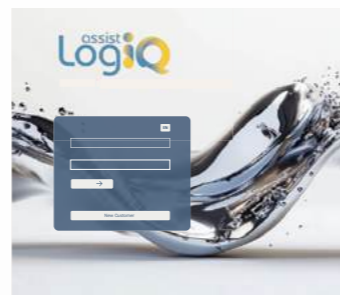

ASSISTLOGIQ®

Adaptability

Scan Region

Compatibility



WORKFLOW



HIGH ACCURACY IN FULL-ARCH SCANS

Minimises stitching errors and enhances precision.



REAL-TIME AUTOMATED VALIDATION

Continuous control and quality verification during scanning.



GUIDED WORKFLOW

From IOS acquisition to STL validation and export.



NO ADDITIONAL HARDWARE REQUIRED

Complete kit with components and AssistLogiq® platform access.



OPEN SYSTEM

Validated STL files ready for any CAD/CAM software.

SCANLOGIQ DATA MARKERS

Precision & Simplicity scanning

One Shot IQ and Reverse IQ are ScanLogiQ® Data Markers for intraoral and extraoral scanning. Both are designed to digitise provisional restorations on single or full-arch implants with maximum precision and efficiency.

Compatible with open digital workflows (Exocad, 3Shape, DentalWings, Blender, Real Guide), it integrates seamlessly into REVERSE-style protocols for predictable, aesthetic and reliable final outcomes.



COMPLETE CLINICAL CAPTURE

Records implant position, occlusion and gingival profile while correlating provisional esthetics to the final design.



PRECISION & SIMPLICITY

Scans directly on the provisional—no splints or auxiliary structures, no saliva or patient movement.

Improves stability and can reduce visits by up to 40%.



DIGITAL INTEGRATION

Works across major CAD/CAM systems and connects naturally with other IPD systems like ScanLogiQ® ensuring workflow continuity and collaboration between clinic and lab.



INNOVATIVE DESIGN

Thanks to their geometry and dimensions, the process of intraoral scanning is more efficient.

MULTI-UNIT AP

Anatomical precision for full-arch restorations

The IPD MUA AP is a trans-epithelial abutment engineered for multi-unit, screw-retained prostheses in full or partial arch cases, including All-on-4® / All-on-6®.

Its anatomical profile promotes soft-tissue adaptation, delivering natural gingival contours, predictable peri-implant sealing and enhanced final aesthetics.

Manufactured in Grade V ELI titanium with differentiated TiN and BLC coatings, it balances strength, biocompatibility and visual harmony across indications.



ANATOMICAL SOFT-TISSUE PROFILE

Curved design supports natural gingival contours and stable tissue integration.



ENHANCED AESTHETIC OUTCOMES

Smooth transition from abutment to gum for harmonious peri-implant appearance.



MATERIAL INTELLIGENCE

Strategic TiN and BLC coatings for durability and biocompatibility



HIGH-PRECISION TITANIUM MANUFACTURING

Optimised for mechanical reliability and long-term clinical performance.



IPDMILLED SYSTEM

Precision and Efficiency in dental implant restorations

In a world where precision and efficiency are paramount, IPDMilled Abutment Blanks provide an advanced, reliable solution for modern dental implantology. Engineered to streamline workflows and ensure consistent, high-quality results, they are the perfect choice for dental technicians committed to excellence.

MULTI-IMPLANT COMPATIBILITY

- Works with leading implant systems.
- Cutting-edge technology.

PATIENT-SPECIFIC CUSTOMIZATION

- Designed for precision and individual needs.

HIGH QUALITY

- Ensures durability, biocompatibility, and long-term performance materials.
- Certified and guaranteed quality



The Holder is the ideal solution for high-performance custom abutment manufacturing. Its robust, validated design ensures safe and precise milling, seamlessly integrating with CAD/CAM software. It enables direct work on blanks with pre-defined connections, optimizing production times and minimizing errors. This system enhances process traceability and maximizes clinical fit accuracy—an essential tool for laboratories aiming for productivity and excellence in oral rehabilitation.”

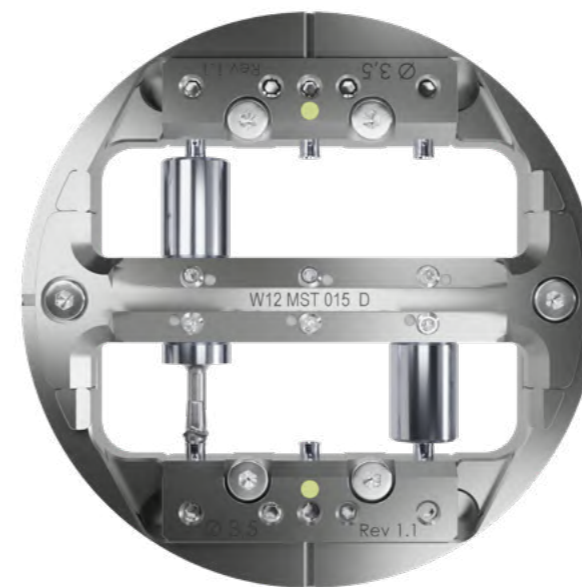

SMART FIXATION

- Patented fixation design for easy premill changes.
- No need to remove the holder from the milling machine.
- Central bar can be quickly and safely extracted.
- Simplifies and speeds up the workflow.
- Expert technical support and guidance.

LIST COMPATIBILITIES AVAILABLE

- Datron
- Dental concept systems®
- DMG MORI®
- Imes-icore®*
- Roboice Dental
- Röders
- VHF Camfacture*
- Yenadent
- Ivoclar*

**When using original CAM software from VHF, Imes or Ivoclar, the manufacturer or reseller must be contacted to request IPD support and its activation.*

If this supplier is unable to provide support, it may be necessary to pay a 'Freedom fee' to unlock the software and allow the use of the IPD support.

**The holder and its components are not medical devices.*

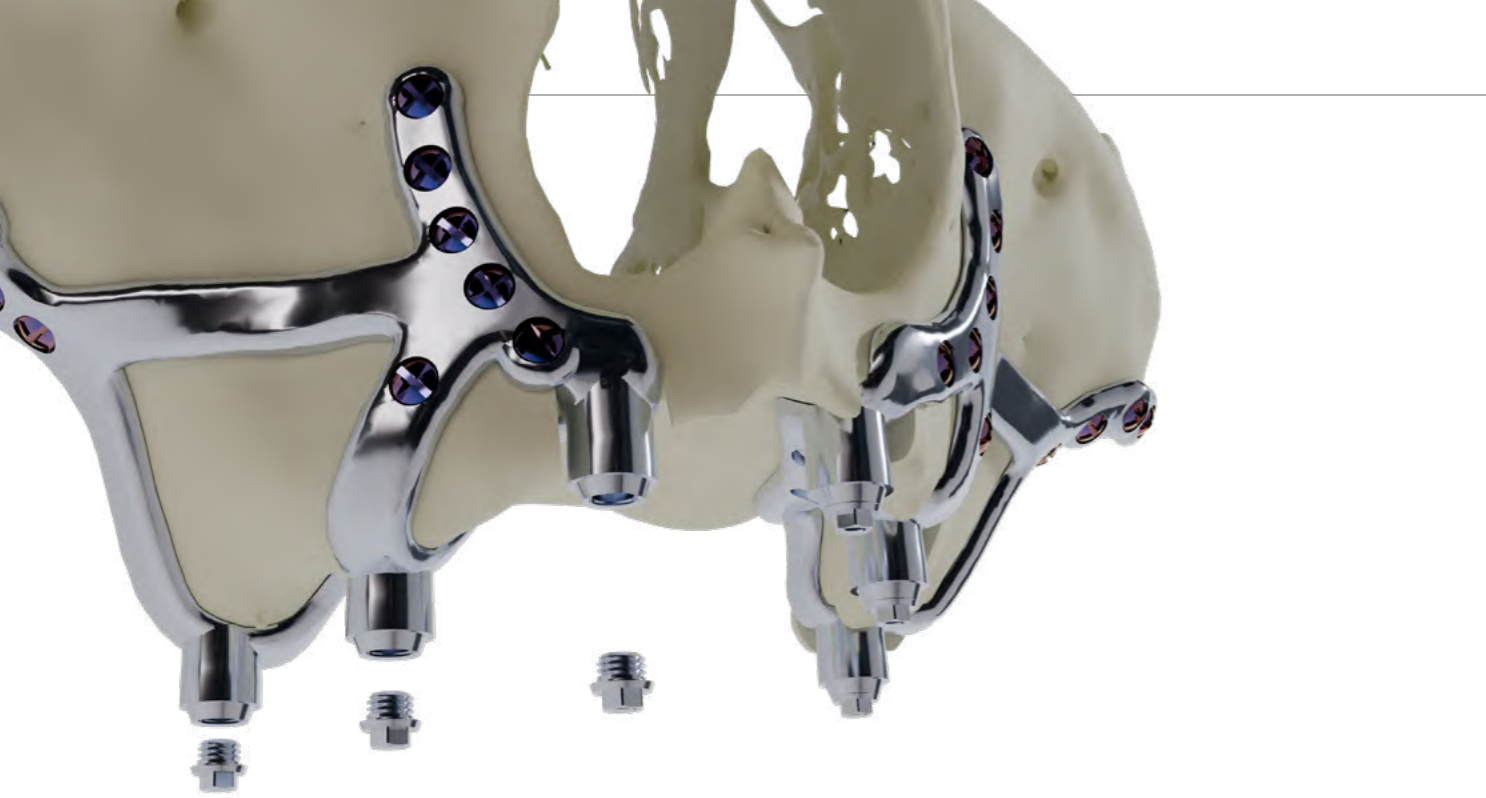

COMING SOON

SUBPERIOSTEAL MUA

Custom SPI prosthetics

The Subperiosteal MUA (IPD/AB-MR-00/SP) ensures a precise, stable interface between custom subperiosteal implants (SPI) and screw-retained prostheses. Its universal Ø4.8 mm platform, optimised narrow profile and open digital compatibility (Exocad, 3Shape, DentalWings, Blender, RealGuide) make it ideal for full-arch cases with limited vertical space.

A unique hybrid solution that combines minimal height, universal compatibility and full clinical control.



MINIMAL HEIGHT

Prosthesis sits directly on the subperiosteal structure, optimising space and enabling rehabilitation in severe atrophy cases.



MODULAR AND REPLACEABLE

The component can be removed or exchanged without altering the implant, enhancing maintenance and managing complications efficiently.



ARCHITECTURE AND COMPATIBILITY

Ø4.8 mm platform and M1.4 thread compatible with leading multi-unit systems and CAD/CAM libraries (Exocad, 3Shape, DentalWings, Blender, RealGuide).

SHOP ONLINE

Access our products wherever you are!

shop.ipd2004.com/es

shop.ipd2004.de/de

shop.ipd2004.fr/fr

shop.ipd2004.pt

shop.ipd2004.be



TRAINING PROGRAMMES

Transform your future with *ipd*



Become an **ipd Pro User** with our training programmes



Facilitate practical interaction with products and solutions through the *ipd* digital workflow.



An opportunity to share our values and expertise with all attendees.



Become familiar with our advanced digital solutions, adapted to customise any type of **restorative implant rehabilitation**.



ORIGINAL ADVANCED SOLUTIONS



PSD SYSTEM



SCAN BODY



MULTI-UNIT SYSTEM

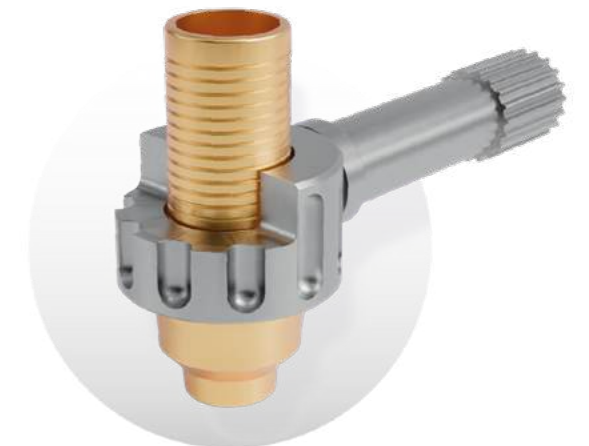

CUSTOM TI-BASE

INDEX

COMPATIBILITIES

MULTI-UNIT	
AB MULTI-UNIT [RP ϕ 4,8]	17
NOBEL BIOCARE®	
AA BRANEMARK SYSTEM® [NP ϕ 3,5 / RP ϕ 4,1 / WP ϕ 5,1]	21
AC REPLACE® SELECT [NP ϕ 3,5 / RP ϕ 4,3 / WP ϕ 5,0]	25
AD ACTIVE® [ϕ 3,0 / NP ϕ 3,5 / RP ϕ 4,3]	29
BIOMET® 3i®	
BA OSSEOTITE® [NP ϕ 3,4 / RP ϕ 4,1 / WP ϕ 5,0]	33
BB OSSEOTITE® CERTAIN® [NP ϕ 3,4 / RP ϕ 4,1 / WP ϕ 5,0]	37
★ BC PILAR DE PERFIL BAJO [RP ϕ 4,8]	41
KLOCKNER®	
CA SK2-NK2 [RP ϕ 4,2]	44
CB ESSENTIAL CONE® [RP ϕ 4,5]	47
CC KL™ [NP ϕ 3,5 / RP ϕ 4,1 / WP ϕ 5,1]	50
CD Vega® [NV ϕ 3,5 / RV ϕ 4,0- ϕ 4,5]	54
STRAUMANN®	
DA TISSUE LEVEL [SynOcta RN ϕ 4,8 / RN ϕ 4,8 / WN ϕ 6,5]	59
DB BONE LEVEL [NC ϕ 3,3 / RC ϕ 4,1]	61
DC BLX® [RB/WB]	65
DD SRA® [ϕ 3,5/ ϕ 4,6]	68
★ DE TLX® [NT / RT / WT]	71
ASTRA®	
EA OSSEOSPEED™ [Uniabutment 20°-40° / Yellow ϕ 3,0 / Aqua ϕ 3,5-4,0 / Lilac ϕ 4,5-5,0]	74
EB EVOLUTION® [XS ϕ 3,0 / S ϕ 3,6 / M ϕ 4,2 / L ϕ 4,8 / XL ϕ 5,4]	79
ZIMMER®	
FA SCREW VENT® [ϕ 3,5 / ϕ 4,5 / ϕ 5,7]	83
FB SWISSPLUS® [SynOcta RN ϕ 4,8, ϕ 4,8]	87
FC EZTETIC® [NP ϕ 3,1]	91
BTI®	
GA EXTERNA [Tiny ϕ 3,5 / Universal ϕ 4,1 / Ancha ϕ 5,5]	94
GB INTERNA [Estrecha ϕ 3,5 / Universal ϕ 4,1 / Ancha ϕ 5,5]	98
GC MULTI-IM® [ϕ 4,1]	102
GD CORE® [Core ϕ 3,5]	104
MICRODENT®	
HA MICRODENT SYSTEM [ϕ 3,5 / ϕ 4,2 / ϕ 5,1]	107
HB MICRODENT UNIVERSAL™ [ϕ 3,5 ϕ 4,1 / ϕ 5,1]	110
DENTSPLY®	
IA XIVE® FRIADENT® [ϕ 3,4 / ϕ 3,8 / ϕ 4,5 / ϕ 5,5]	114
IB ANKYLOS® [Balance Base / C/X]	117
CAMLOG®	
JA CAMLOG® IMPLANT SYSTEM [ϕ 3,3 / ϕ 3,8 / ϕ 4,3 / ϕ 5,0]	119
JB CONELOG® [ϕ 3,3 / ϕ 3,8 / ϕ 4,3 / ϕ 5,0]	122
BIOHORIZONS®	
LB TAPERED INTERNAL [ϕ 3,0 / ϕ 3,5 / ϕ 4,5 / ϕ 5,7]	125
LC TAPERED PRO CONICAL [Narrow ϕ 3,3 / Regular ϕ 3,8]	129
SWEDEN & MARTINA®	
MA OUTLINK® [ϕ 3,3 / ϕ 4,1 / ϕ 5,0]	132
MB PREMIUM™ KOHNO® [ϕ 3,3 / ϕ 3,8 / ϕ 4,25 / ϕ 5,0]	136

PHIBO®	
NA TSH® [S2 / S3-S4 / S5]	139
OSSTEM IMPLANT®	
OB TSIII [M ϕ 3,5 / R ϕ 4,0]	143
BIOTECH® DENTAL	
QB KONTACT® [RP]	146
NEODENT®	
RA HELIX® HE [ϕ 3,3 / ϕ 4,1 / ϕ 5,0]	149
RB GRAND MORSETM GM [GM]	153
RC GM ABUTMENT [RP ϕ 4,8]	156
RD GM MICRO ABUTMENT [ϕ 3,5]	158
BEGO® SEMADOS®	
SB SC/RS [ϕ 3,25- ϕ 3,75 / ϕ 4,1 / ϕ 4,5 / ϕ 5,5]	160
MIS®	
TA SEVEN® [Narrow NP ϕ 3,3 / Standard SP / Wide WP]	163
TB C1 [Narrow NP / Standard SP / Wide WP]	167
TC V3® [Narrow NP / Standard SP]	171
DIO®	
UB UFII [NP (N) / RP (R)]	175
MEGAGEN®	
WA ANYONE® [RP]	178
WB ANYRIDGE® [ϕ 4,0]	181
DENTIUM®	
XA IMPLANTIUM® / SUPERLINE™ [RP]	184
MEDENTIS®	
YB ICX [RP]	187
BREDED®	
★ ZA BLUE SKY® [ϕ 3,5 / ϕ 4,0]	190
GLOBAL D®	
1A IN-KONE® [RP]	191
ANTHOGYR®	
2A AXIOM® BL [RP]	194
GALIMPLANT®	
3A MULTI-POSITION AESTHETIC® [ϕ 3,8]	197
NEOSS®	
★ 6A PROACTIVE® [NP / SP]	199
THOMMEN MEDICAL	
★ 7A SPI® [ϕ 3,5 / ϕ 4,0 / ϕ 4,5 / ϕ 5,0 / ϕ 6,0]	200
PRODUCT WORKFLOWS	202

WORKING SYSTEMS

ACCESSORIES	206
TECHNICAL SPECIFICATIONS	208
CE MARK	213



Download the interactive catalog.

★ Is a new available compatibility in the 2026 Catalogue.

*Some products may not be available in your country. Please contact your official distributor for more details.

MULTI-UNIT

AB

Prosthetic Platform [RP ϕ 4.8]

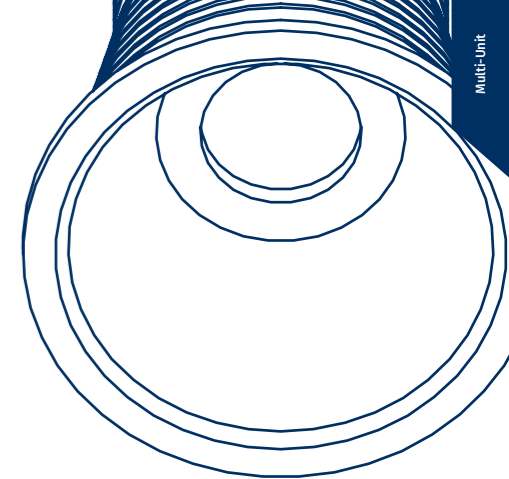

SCAN BODY / SCAN DATA MARKER

	Indication	Height (mm)	RP ϕ 4.8
Scan Body		10	IPD/AB-SR-00
		10	IPD/AB-SR-01
One Shot IQ		6	IPD/AB-SR-03
Reverse IQ			IPD/AB-SR-00/RS

Captive screw included except on Reverse Marker IQ. H1.20 Screwdriver.

	Indication	Height (mm)	RP ϕ 4.8
Scan Transfer		12.5	IPD/AB-SR-11
	Screw		IPD/AB-TR-11/C

Screw and protective cap included. 1.20 Hex Screwdriver.



SCANLOGIQ® FULL ARCH SYSTEM* NEW

*Check availability



			RP ϕ 4.8
ScanLogiQ® KIT	ScanLogiQ® Box	1 Scan Flag IQ Set 6 One Shot IQ 6 Reverse IQ 1 Control Plate IQ 1 Screwdriver 1 Clinical Handle	IPD/AB-KR-00/FS
Scan Flag IQ SET		3 Short 3 Medium 4 Large 0° 2 Large +20° 2 Large -20°	IPD/AB-KR-01/FS
Control Plate IQ			IPD/KT-FS-00

Captive screw IPD/AB-TR-00/FS included on all Scan Flag IQ. 1.25 Hex Screwdriver.



[RETURN TO INDEX](#)

Ti-BASE  Custom Ti-Base System®

Indication	Post Height (mm)	Gingival Height (mm)	RP ϕ 4.8
	3.5	0.5	IPD/AB-IR-00/3D
	6.5	0.5	IPD/AB-IR-02/3D
	3.5	0.2	IPD/AB-IR-01/3D
	3.85	0.2	IPD/AB-IR-11/3D
	6.5	0.2	IPD/AB-IR-03/3D



SCREWS

IPD and OEM compatible			RP ϕ 4.8
Screwdriver	Coating	Seat	Torque value
Unigrip	-	Flat	15 Ncm
Unigrip	TiN	Flat	15 Ncm
Unigrip	BLC	Flat	15 Ncm



For straight channels		For ASC options	
Screwdriver	Coating	Indication	Torque value
TPA	TiN	For PH 3.5 & 3.85 mm Ti-Bases	15 Ncm
TPA	TiN	For PH 6.5 mm Ti-Bases	15 Ncm



Additional options			
Screwdriver	Coating	Indication	Torque value
TPA	TiN	For Zr a PMMA implant level	15 Ncm

MULTI-UNIT ABUTMENT SUBPERIOSTEAL IMPLANTS* 

*Check availability

RP ϕ 4.8	
	IPD/AB-MR-00/SP

*Coming soon





ANALOGS



Type	RP ϕ 4.8
Standard	IPD/AB-AR-00
Digital	Full set
	IPD/AB-AR-90/3D
	Analog
	Bottom Screw
	Side Screw



Co-Cr BASE ABUTMENT

Co-Cr Base for analogic workflow			RP ϕ 4.8
Indication	Angulation		
	0°		IPD/AB-BR-00
	15°		IPD/AB-BR-10
	25°		IPD/AB-BR-20
	0°		IPD/AB-BR-01
	15°		IPD/AB-BR-11
	25°		IPD/AB-BR-21



Co-Cr Base for digital workflow			RP ϕ 4.8
Indication	Angulation		
	Straight/ASC		IPD/AB-BR-00/3D
	Straight/ASC		IPD/AB-BR-01/3D
		Scan Body	IPD/SC-AN-B2



All ASC CoCr analogic workflow abutments include the relevant TPA screw.

CASTABLE ABUTMENT

Indication	RP ϕ 4.8
	IPD/AB-RR-00



PSD OVERDENTURE ABUTMENT

Indication	Gingival Height (mm)	RP ϕ 4.8
	2.75	2 units pack IPD/AB-LR-02

Please see page 205 for the PSD system accessories.





COPING ABUTMENT

Type	RP ϕ 4.8
Open tray	IPD/AB-CR-00
Closed tray	IPD/AB-CR-01
Classic Design	



TEMPORARY ABUTMENT / OPEN TRAY COPING

Indication	Gingival Height (mm)	RP ϕ 4.8
	1.5	IPD/AB-PR-01
	0.2	IPD/AB-PR-07
	1.5	IPD/AB-PR-00
		Long coping screw IPD/AB-TR-00/C

The same abutment can be used as a temporary abutment with the occlusal screw or as an impression coping using the coping screw.

Additional options		
	1.5	Classic design IPD/AB-PR-06

The Classic design abutment is equivalent to the OEM and cannot be used as coping.



MULTI-UNIT AB

HEALING ABUTMENT

Material	Gingival Height (mm)	Head Diameter (mm)	RP ϕ 4.8
POM	4.45	Bottom ϕ 5.0 - Top ϕ 3.67	IPD/AB-DR-00
Titanium	4.45		IPD/AB-DR-01
		Screw	IPD/AB-TR-00

Screw not included



SCREWDRIVERS

Type	Length (mm)	RP ϕ 4.8
Implant system Screwdriver		
	18	IPD/PU-00-18
Unigrip	25	IPD/PU-00-25
	32	IPD/PU-00-32
IPD Scan Body and extra Screwdrivers		
	18	IPD/PH-20-18
1.20 Hex	25	IPD/PH-20-25
	32	IPD/PH-20-32
ASC Screwdriver		
	18	IPD/KA-CT-18
TPA	25	IPD/KA-CT-25
	32	IPD/KA-CT-32
Dedicated tools		
2.0 Hex	For straight MUA abutments	20 IPD/LL-AB-00
	Angled MUA Carrier	IPD/LL-TM-00

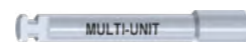

ACCESSORIES

Indication	Length (mm)	RP ϕ 4.8
Clinical RA Shank Handle	16	IPD/MC-00-16
Laboratory RA Shank Handle	70	IPD/ML-00-70
RA Shank Ratchet	90	IPD/DI-00-90
Ratchet adapter	-	IPD/DI-KA-90

Please see page 210 for more information.

NOBEL BIOCARE

AA BRANEMARK SYSTEM®

Prosthetic Platform [NP ϕ 3.5 / RP ϕ 4.1 / WP ϕ 5.1]

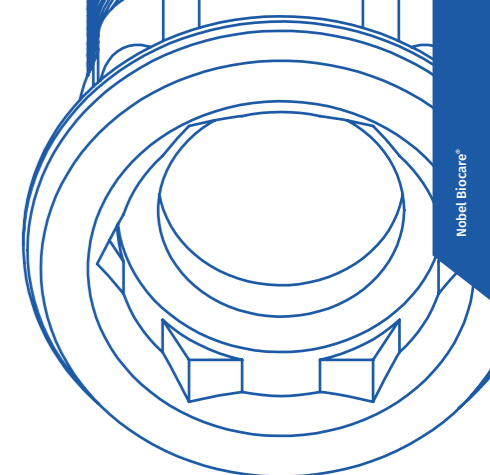

SCAN BODY

	Indication	Height (mm)	NP ϕ 3.5	RP ϕ 4.1	WP ϕ 5.1
Scan Body		10	IPD/AA-SN-00	IPD/AA-SR-00	IPD/AA-SW-00
		15	IPD/AA-SN-02	IPD/AA-SR-02	-
		10	IPD/AA-SN-01	IPD/AA-SR-01	IPD/AA-SW-01

Captive screw included. 1.20 Hex Screwdriver.



Ti-BASE Custom Ti-Base System®

Indication	Gingival Height (mm)	NP ϕ 3.5	RP ϕ 4.1	WP ϕ 5.1
	0.5	-	IPD/AA-IR-00/3D	-
	1.3	-	-	IPD/AA-IW-02/3D
	1.5	IPD/AA-IN-02/3D	IPD/AA-IR-02/3D	-
	2.5	-	IPD/AA-IR-04/3D	-
	Cutting guide KIT		IPD/KT-IN-00	IPD/KT-IR-00
	0.5	-	IPD/AA-IR-01/3D	-
	1.3	-	-	IPD/AA-IW-03/3D*
	1.5	IPD/AA-IN-03/3D	IPD/AA-IR-03/3D	-
	2.5	-	IPD/AA-IR-05/3D	-
	Cutting guide KIT		IPD/KT-IN-01	IPD/KT-IR-01

Please see page 204 for the IPD Custom Interface System accessories.

*Only available PH 3.5 mm version.



IPDMILLED SYSTEM*

*Check availability

Indication	Material	Diameter (mm)	NP ϕ 3.5	RP ϕ 4.1	WP ϕ 5.1
TYPE A System (Compatible with DESS® Holders)					
	Ti	15	PR/AA-XN-15/A	PR/AA-XR-15/A	PR/AA-XW-15/A

All premilled abutments include 2 titanium screws.



[RETURN TO INDEX](#)

SCREWS

			NP ø3.5	RP ø4.1	WP ø5.1	
IPD compatible	For straight channels	Torque value	35 Ncm	35 Ncm	35 Ncm	
Screwdriver	Coating	Seat				
Unigrip	-	Conical	IPD/AA-TN-00	IPD/AA-TR-00	IPD/AA-TW-01	
Unigrip	TiN	Conical	IPD/AA-TN-00/TiN	IPD/AA-TR-00/TiN	IPD/AA-TW-01/TiN	
Unigrip	BLC	Conical	IPD/AA-TN-00/BLC	IPD/AA-TR-00/BLC	IPD/AA-TW-01/BLC	
For ASC options			Torque value	20 Ncm	25 Ncm	25 Ncm
Screwdriver	Coating	Seat				
TPA	TiN	Conical	IPD/AA-TN-50	IPD/AA-TR-50	IPD/AA-TW-50	
OEM compatible			Torque value	35 Ncm	35 Ncm	35 Ncm
Screwdriver	Coating	Seat				
Unigrip	-	Conical	IPD/AA-TN-00	IPD/AA-TR-00	IPD/AA-TW-00	
Unigrip	TiN	Conical	IPD/AA-TN-00/TiN	IPD/AA-TR-00/TiN	IPD/AA-TW-00/TiN	
Unigrip	BLC	Conical	IPD/AA-TN-00/BLC	IPD/AA-TR-00/BLC	IPD/AA-TW-00/BLC	
Additional options			Torque value	35 Ncm	35 Ncm	35 Ncm
Screwdriver	Coating	Type				
Unigrip	-	For implant level flat seat	-	IPD/AA-TR-02	-	
Unigrip	TiN	For implant level flat seat	-	IPD/AA-TR-02/TiN	-	
Unigrip	BLC	For implant level flat seat	-	IPD/AA-TR-02/BLC	-	
TPA	TiN	For implant level flat seat	-	IPD/AA-TR-52	-	
			Torque value	20 Ncm	20 Ncm	20 Ncm
1.20 Hex	-	Low profile head - conical seat	-	IPD/AA-TR-01	-	
1.20 Hex	TiN	Low profile head - conical seat	-	IPD/AA-TR-01/TiN	-	
1.20 Hex	BLC	Low profile head - conical seat	-	IPD/AA-TR-01/BLC	-	



MULTI-UNIT ABUTMENT

Angulation	Indication	Gingival Height (mm)	NP ø3.5	RP ø4.1	WP ø5.1
0°		1.0	IPD/AA-MN-01	IPD/AB-MR-01	-
		2.0	IPD/AA-MN-02	IPD/AB-MR-02	-
		3.0	IPD/AA-MN-03	IPD/AB-MR-03	-
		4.0	-	IPD/AB-MR-04	-
		5.0	-	IPD/AB-MR-05	-
17°		2.0	-	IPD/AB-MR-12	-
		3.0	-	IPD/AB-MR-13	-
		4.0	-	IPD/AB-MR-14	-
		5.0	-	IPD/AB-MR-15	-
30°		3.0	-	IPD/AB-MR-33	-
		4.0	-	IPD/AB-MR-34	-
		5.0	-	IPD/AB-MR-35	-
Replacement Screw for Angled MUA			-	IPD/KA-MT-00	-

Straight Multi-unit abutments can be used for single and multiple restorations. Please see page 206 for the Multi-unit system accessories.



ANALOGS

Type		NP ø3.5	RP ø4.1	WP ø5.1
Standard		IPD/AA-AN-00	IPD/AA-AR-00	IPD/AA-AW-00
	Full set	IPD/AA-AN-90/3D	IPD/AA-AR-90/3D	IPD/AA-AW-90/3D
Digital	Analogue			
	Bottom Screw			
	Side Screw			



Co-Cr BASE ABUTMENT

		NP ø3.5	RP ø4.1	WP ø5.1
Co-Cr Base for analogic workflow				
Indication	Angulation			
	0°	IPD/AA-BN-00	IPD/AA-BR-00	-
	15°	IPD/AA-BN-10	IPD/AA-BR-10	-
	25°	IPD/AA-BN-20	IPD/AA-BR-20	-
	0°	IPD/AA-BN-01	IPD/AA-BR-01	-
	15°	IPD/AA-BN-11	IPD/AA-BR-11	-
	25°	IPD/AA-BN-21	IPD/AA-BR-21	-
Co-Cr Base for digital workflow				
Indication	Angulation			
	Straight/ASC	IPD/AA-BN-00/3D	IPD/AA-BR-00/3D	-
	Straight/ASC	IPD/AA-BN-01/3D	IPD/AA-BR-01/3D	-
Scan Body		IPD/SC-AN-B1	IPD/SC-AN-B1	-

All ASC CoCr analogic workflow abutments include the relevant TPA screw.



CASTABLE ABUTMENT

Indication	NP ø3.5	RP ø4.1	WP ø5.1
	-	IPD/AA-HR-00	IPD/AA-HW-00
	-	IPD/AA-RR-00	IPD/AA-RW-00



PSD OVERDENTURE ABUTMENT

Indication	Gingival Height (mm)	NP ø3.5	RP ø4.1	WP ø5.1
	1.0	IPD/AA-LN-01	IPD/AA-LR-01	-
	2.0	-	IPD/AA-LR-02	IPD/RA-LW-02
	3.0	IPD/AA-LN-03	IPD/AA-LR-03	IPD/RA-LW-03
	4.0	-	IPD/AA-LR-04	IPD/RA-LW-04
	5.0	IPD/AA-LN-05	IPD/AA-LR-05	-

Please see page 205 for the PSD system accessories.



COPING ABUTMENT

Type	NP ø3.5	RP ø4.1	WP ø5.1
Open tray	-	IPD/AA-CR-00	IPD/AA-CW-00
Closed tray	-	IPD/AA-CR-01	-

Classic Design



TEMPORARY ABUTMENT / OPEN TRAY COPING

Indication	Gingival Height (mm)	NP ø3.5	RP ø4.1	WP ø5.1
	1.5	IPD/AA-PN-06	IPD/AA-PR-06	IPD/AA-PW-06
	1.5	IPD/AA-PN-07	IPD/AA-PR-07	IPD/AA-PW-07
Long coping screw		IPD/AA-TN-00/C	IPD/AA-TR-00/C	IPD/AA-TW-00/C

The same abutment can be used as a temporary abutment with the occlusal screw or as an impression coping using the coping screw.



HEALING ABUTMENT

Gingival Height (mm)	NP ø3.5	RP ø4.1	WP ø5.1
	Head Diameter (mm)		
	ø4.0	ø4.7	ø5.5
2.0	IPD/AA-DN-02	IPD/AA-DR-02	IPD/AA-DW-02
3.0	IPD/AA-DN-03	IPD/AA-DR-03	IPD/AA-DW-03
4.0	IPD/AA-DN-04	IPD/AA-DR-04	IPD/AA-DW-04
5.0	-	IPD/AA-DR-05	-



TI CEMENT-RETAINED ABUTMENT

Indication	Angulation	Gingival Height	NP ø3.5	RP ø4.1	WP ø5.1
	0°	2.0	-	IPD/AA-PR-00	-
	15°	1.0	-	IPD/AA-PR-02	-
		2.0	-	IPD/AA-PR-04	-
	25°	1.0	-	IPD/AA-PR-03	-
		2.0	-	IPD/AA-PR-05	-
	0°	2.0	-	IPD/AA-PR-01	-

Using the Low profile IPD/AA-TR-01 screw for IPD/AA-PR-04 is recommended



SCREWDRIVERS

Type	Length (mm)	NP ø3.5	RP ø4.1	WP ø5.1
Implant system Screwdriver				
Unigrip	18	IPD/PU-00-18	IPD/PU-00-18	IPD/PU-00-18
	25	IPD/PU-00-25	IPD/PU-00-25	IPD/PU-00-25
	32	IPD/PU-00-32	IPD/PU-00-32	IPD/PU-00-32
IPD Scan Body and extra Screwdrivers				
1.20 Hex	18	IPD/PH-20-18	IPD/PH-20-18	IPD/PH-20-18
	25	IPD/PH-20-25	IPD/PH-20-25	IPD/PH-20-25
	32	IPD/PH-20-32	IPD/PH-20-32	IPD/PH-20-32
ASC Screwdriver				
TPA	18	IPD/KA-CT-18	IPD/KA-CT-18	IPD/KA-CT-18
	25	IPD/KA-CT-25	IPD/KA-CT-25	IPD/KA-CT-25
	32	IPD/KA-CT-32	IPD/KA-CT-32	IPD/KA-CT-32
PSD Screwdriver				
PSD	25	IPD/LL-PS-00	IPD/LL-PS-00	IPD/LL-PS-00



ACCESSORIES

Indication	Length (mm)	NP ø3.5	RP ø4.1	WP ø5.1
Clinical RA Shank Handle	16	IPD/MC-00-16	IPD/MC-00-16	IPD/MC-00-16
Laboratory RA Shank Handle	70	IPD/ML-00-70	IPD/ML-00-70	IPD/ML-00-70
RA Shank Ratchet	90	IPD/DI-00-90	IPD/DI-00-90	IPD/DI-00-90
Ratchet adapter		IPD/DI-KA-90	IPD/DI-KA-90	IPD/DI-KA-90
PSD and insert extractor tool		IPD/LL-PS-01	IPD/LL-PS-01	IPD/LL-PS-01

Please see page 210 for more information.



NOBEL BIO CARE

AC REPLACE® SELECT

Prosthetic Platform [NP ø3.5 / RP ø4.3 / WP ø5.0]

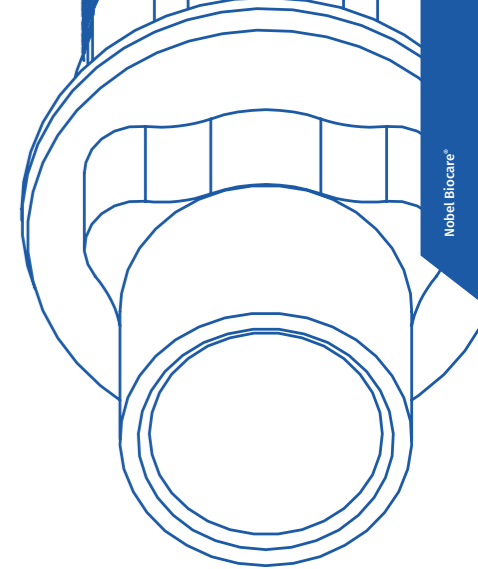

SCAN BODY

	Indication	Height (mm)	NP ø3.5	RP ø4.3	WP ø5.0
Scan Body		10	IPD/AC-SN-00	IPD/AC-SR-00	IPD/AC-SW-00
		15	IPD/AC-SN-02	IPD/AC-SR-02	IPD/AC-SW-02
		10	IPD/AC-SN-01	IPD/AC-SR-01	IPD/AC-SW-01

Captive screw included. 1.20 Hex Screwdriver.



Ti-BASE Custom Ti-Base System®

Indication	Gingival Height (mm)	NP ø3.5	RP ø4.3	WP ø5.0	
	0.5	IPD/AC-IN-00/3D	IPD/AC-IR-00/3D	IPD/AC-IW-00/3D	
	1.5	IPD/AC-IN-02/3D	IPD/AC-IR-02/3D	IPD/AC-IW-02/3D	
	Cutting guide KIT		IPD/KT-IN-00	IPD/KT-IR-00	IPD/KT-IW-00
	0.5		IPD/AC-IN-01/3D	IPD/AC-IR-01/3D	IPD/AC-IW-01/3D
	1.5		IPD/AC-IN-03/3D	IPD/AC-IR-03/3D	IPD/AC-IW-03/3D
	Cutting guide KIT		IPD/KT-IN-01	IPD/KT-IR-01	IPD/KT-IW-01

Please see page 204 for the IPD Custom Interface System accessories.



IPDMILLED SYSTEM*

*Check availability

Indication	Material	Diameter (mm)	NP ø3.5	RP ø4.3	WP ø5.0
IPD Blank System (Compatible with NT/IPD Holders)					
	Ti	12	IPD/AC-XN-00	IPD/AC-XR-00	IPD/AC-XW-00
Mill Analog			IPD/AC-AN-00/X	IPD/AC-AR-00/X	IPD/AC-AW-00/X
TYPE A System (Compatible with DESS® Holders)					
	Ti	15	PR/AC-XN-15/A	PR/AC-XR-15/A	PR/AC-XW-15/A

All premilled abutments include 2 titanium screws.



RETURN TO INDEX

SCREWS

			NP ø3.5	RP ø4.3	WP ø5.0
IPD and OEM compatible	For straight channels	Torque value	35 Ncm	35 Ncm	35 Ncm
Screwdriver	Coating	Seat			
Unigrip	-	Flat	IPD/AC-TN-00	IPD/AC-TR-00	IPD/AC-TR-00
Unigrip	TiN	Flat	IPD/AC-TN-00/TiN	IPD/AC-TR-00/TiN	IPD/AC-TR-00/TiN
Unigrip	BLC	Flat	IPD/AC-TN-00/BLC	IPD/AC-TR-00/BLC	IPD/AC-TR-00/BLC
For ASC options		Torque value	25 Ncm	25 Ncm	25 Ncm
Screwdriver	Coating	Seat			
TPA	TiN	Flat	IPD/AC-TN-50	IPD/AC-TR-50	IPD/AC-TR-50
For ASC on CrCo abutments		Torque value	25 Ncm	25 Ncm	25 Ncm
Screwdriver	Coating	Angle			
TPA	TiN	10°	IPD/AC-TN-50	IPD/AC-TR-51	IPD/AC-TR-51
TPA	TiN	20°	IPD/AC-TN-51	-	-



MULTI-UNIT ABUTMENT

Angulation	Indication	Gingival Height (mm)	NP ø3.5	RP ø4.3	WP ø5.0
0°		1.0	IPD/AC-MN-01	IPD/AC-MR-01	-
		2.0	IPD/AC-MN-02	IPD/AC-MR-02	-
		3.0	-	IPD/AC-MR-03	-
		4.0	-	IPD/AC-MR-04	-
		5.0	-	IPD/AC-MR-05	-
17°		3.0	-	IPD/AC-MR-13	-
30°		4.0	-	IPD/AC-MR-34	-
	Replacement Screw for Angled MUA		-	IPD/KA-MT-01	-

Straight Multi-unit abutments can be used for single and multiple restorations. Please see page 206 for the Multi-unit system accessories.



MULTI-UNIT AP ABUTMENT* NEW

*Check availability

Angulation	Indication	Gingival Height (mm)	NP ø3.5	RP ø4.3	WP ø5.0
17°		2.0	-	IPD/AC-MR-12/AP	-
		3.0	-	IPD/AC-MR-13/AP	-
30°		3.0	-	IPD/AC-MR-33/AP	-
		4.0	-	IPD/AC-MR-34/AP	-
	Replacement Screw for Angled MUA AP		-	IPD/KA-MT-01/BLC	-

Please see page 206 for the Multi-unit system accessories.



ANALOGS

Indication		NP ø3.5	RP ø4.3	WP ø5.0
Standard		IPD/AC-AN-00	IPD/AC-AR-00	IPD/AC-AW-00
	Full set	IPD/AC-AN-90/3D	IPD/AC-AR-90/3D	IPD/AC-AW-90/3D
Digital	Analog			
	Bottom Screw			
	Side Screw			



Co-Cr BASE ABUTMENT

			NP ø3.5	RP ø4.3	WP ø5.0
Co-Cr Base for analogic workflow					
Indication	Angulation				
	0°		IPD/AC-BN-00	IPD/AC-BR-00	-
	15°		IPD/AC-BN-10	IPD/AC-BR-10	-
	25°		IPD/AC-BN-20	-	-
	0°		IPD/AC-BN-01	IPD/AC-BR-01	-
	15°		IPD/AC-BN-11	IPD/AC-BR-11	-
	25°		IPD/AC-BN-21	-	-
Co-Cr Base for digital workflow					
Indication	Angulation				
	Straight		IPD/AC-BN-00/3D	IPD/AC-BR-00/3D	-
	ASC		-	IPD/AC-BR-A0/3D	-
	Straight		IPD/AC-BN-01/3D	IPD/AC-BR-01/3D	-
	ASC		IPD/AC-BN-A1/3D	IPD/AC-BR-A1/3D	-
		Scan Body	IPD/SC-AN-B1	IPD/SC-AN-B1	-

All ASC CoCr analogic workflow abutments include the relevant TPA screw.



CASTABLE ABUTMENT

Indication		NP ø3.5	RP ø4.3	WP ø5.0
		-	IPD/AC-HR-00	IPD/AC-HW-00
		-	IPD/AC-RR-00	IPD/AC-RW-00



PSD OVERDENTURE ABUTMENT

Indication	Gingival Height (mm)	NP ø3.5	RP ø4.3	WP ø5.0
	1.0		IPD/AC-LR-01	-
	3.0	IPD/AC-LN-03	IPD/AC-LR-03	-
	5.0	IPD/AC-LN-05	IPD/AC-LR-05	-

Please see page 205 for the PSD system accessories.



COPING ABUTMENT

Type		NP ø3.5	RP ø4.3	WP ø5.0
Open tray		-	-	IPD/AC-CW-00
Closed tray		IPD/AC-CN-01	IPD/AC-CR-01	-

Classic Design



TEMPORARY ABUTMENT / OPEN TRAY COPING

Indication	Gingival Height (mm)	NP ø3.5	RP ø4.3	WP ø5.0
	1.5	IPD/AC-PN-06	IPD/AC-PR-06	-
	1.5	IPD/AC-PN-07	IPD/AC-PR-07	-
		Long coping screw	IPD/AC-TN-00/C	IPD/AC-TR-00/C

The same abutment can be used as a temporary abutment with the occlusal screw or as an impression coping using the coping screw.



HEALING ABUTMENT

Gingival Height (mm)		NP ø3.5	RP ø4.3	WP ø5.0
	Head Diameter (mm)	ø3.5	ø4.3	ø5.0
3.0		IPD/AC-DN-03	IPD/AC-DR-03	IPD/AC-DW-03
5.0		IPD/AC-DN-05	IPD/AC-DR-05	IPD/AC-DW-05
7.0		IPD/AC-DN-07	-	-



TI CEMENT-RETAINED ABUTMENT

Indication	Angulation	Gingival Height	NP ø3.5	RP ø4.3	WP ø5.0
	0°	2.0	IPD/AC-PN-00	IPD/AC-PR-00	IPD/AC-PW-00



SCREWDRIVERS

Type	Length (mm)	NP ø3.5	RP ø4.3	WP ø5.0
Implant system Screwdriver				
Unigrip	18	IPD/PU-00-18	IPD/PU-00-18	IPD/PU-00-18
	25	IPD/PU-00-25	IPD/PU-00-25	IPD/PU-00-25
	32	IPD/PU-00-32	IPD/PU-00-32	IPD/PU-00-32
IPD Scan Body and extra Screwdrivers				
1.20 Hex	18	IPD/PH-20-18	IPD/PH-20-18	IPD/PH-20-18
	25	IPD/PH-20-25	IPD/PH-20-25	IPD/PH-20-25
	32	IPD/PH-20-32	IPD/PH-20-32	IPD/PH-20-32
ASC Screwdriver				
TPA	18	IPD/KA-CT-18	IPD/KA-CT-18	IPD/KA-CT-18
	25	IPD/KA-CT-25	IPD/KA-CT-25	IPD/KA-CT-25
	32	IPD/KA-CT-32	IPD/KA-CT-32	IPD/KA-CT-32
PSD Screwdriver				
PSD	25	IPD/LL-PS-00	IPD/LL-PS-00	-



ACCESSORIES

Indication	Length (mm)	NP ø3.5	RP ø4.3	WP ø5.0
Clinical RA Shank Handle	16	IPD/MC-00-16	IPD/MC-00-16	IPD/MC-00-16
Laboratory RA Shank Handle	70	IPD/ML-00-70	IPD/ML-00-70	IPD/ML-00-70
RA Shank Ratchet	90	IPD/DI-00-90	IPD/DI-00-90	IPD/DI-00-90
Ratchet adapter		IPD/DI-KA-90	IPD/DI-KA-90	IPD/DI-KA-90
PSD and insert extractor tool		IPD/LL-PS-01	IPD/LL-PS-01	-



Please see page 210 for more information.

NOBEL BIO CARE

AD ACTIVE® Prosthetic Platform [ø3.0 / NP ø3.5 / RP ø4.3]

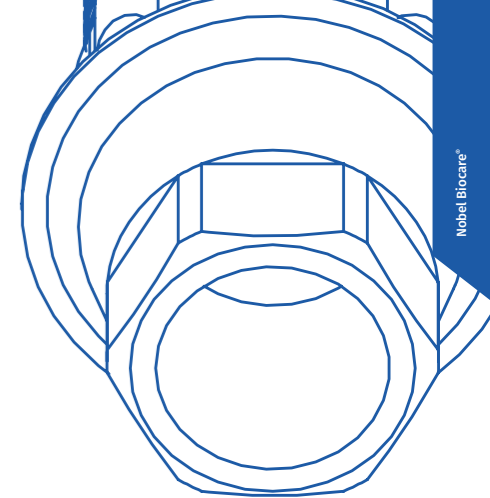

SCAN BODY

	Indication	Height (mm)	ø3.0	NP ø3.5	RP ø4.3
Scan Body		10	IPD/AD-ST-00	IPD/AD-SN-00	IPD/AD-SR-00
		15	IPD/AD-ST-02	IPD/AD-SN-02	IPD/AD-SR-02
		10	IPD/AD-ST-01	IPD/AD-SN-01	IPD/AD-SR-01



Captive screw included. 1.20 Hex Screwdriver.

Ti-BASE *ipd* Custom Ti-Base System®

Indication	Gingival Height (mm)	ø3.0	NP ø3.5	RP ø4.3
	0.5	-	IPD/AD-IN-00/3D	IPD/AD-IR-00/3D
	0.8	IPD/AD-IT-00/3D	-	-
	1.5	IPD/AD-IT-02/3D	IPD/AD-IN-02/3D	IPD/AD-IR-02/3D
	2.5	IPD/AD-IT-04/3D	IPD/AD-IN-04/3D	IPD/AD-IR-04/3D
	3.5	-	IPD/AD-IN-06/3D	-
	Cutting guide KIT		IPD/KT-IN-00	IPD/KT-IN-00
	0.5	-	IPD/AD-IN-01/3D	IPD/AD-IR-01/3D
	0.8	IPD/AD-IT-01/3D	-	-
	1.5	IPD/AD-IT-03/3D	IPD/AD-IN-03/3D	IPD/AD-IR-03/3D
	2.5	IPD/AD-IT-05/3D	IPD/AD-IN-05/3D	IPD/AD-IR-05/3D
	3.5	-	IPD/AD-IN-07/3D	-
	Cutting guide KIT		IPD/KT-IN-01	IPD/KT-IN-01



Please see page 204 for the IPD Custom Interface System accessories.

CEREC® TI-BASE SYSTEM

Indication	Gingival Height (mm)	ø3.0	NP ø3.5	RP ø4.3
	0.5	-	IPD/AD-IN-00/SI	IPD/AD-IR-00/SI
	1.5	-	IPD/AD-IN-02/SI	IPD/AD-IR-02/SI
	2.5	-	IPD/AD-IN-04/SI	IPD/AD-IR-04/SI
Cerec Block (S/L)		-	S	L
Cerec Library Code		-	B C 3.4	NB B 4.1



TiN screw included.

RETURN TO INDEX

IPDMILLED SYSTEM* **NEW**

*Check availability

Indication	Material	Diameter (mm)	ø3.0	NP ø3.5	RP ø4.3
IPD Blank System (Compatible with NT/IPD Holders)					
	Ti	12	-	IPD/AD-XN-00	IPD/AD-XR-00
Mill Analog				IPD/AD-AN-00/X	IPD/AD-AR-00/X
TYPE A System (Compatible with DESS® Holders)					
	Ti	15	-	PR/AD-XN-15/A	PR/AD-XR-15/A

All premilled abutments include 2 titanium screws.

SCREWS

IPD and OEM compatible	For straight channels	Torque value	ø3.0	NP ø3.5	RP ø4.3
			15 Ncm	35 Ncm	35 Ncm
Screwdriver	Coating	Seat			
Unigrip	-	Conical	IPD/AD-TT-00	IPD/AA-TN-00	IPD/AA-TR-00
Unigrip	TiN	Conical	IPD/AD-TT-00/TiN	IPD/AA-TN-00/TiN	IPD/AA-TR-00/TiN
Unigrip	BLC	Conical	IPD/AD-TT-00/BLC	IPD/AA-TN-00/BLC	IPD/AA-TR-00/BLC
	For ASC options	Torque value	15 Ncm	20 Ncm	25 Ncm
Screwdriver	Coating	Seat			
TPA	TiN	Conical	IPD/AD-TT-50	IPD/AA-TN-50	IPD/AD-TR-50
	For ASC on CrCo abutments	Torque value	-	35 Ncm	35 Ncm
Screwdriver	Coating	Seat			
Unigrip	-	Conical	-	IPD/AD-TN-00/X	IPD/AD-TR-00/X

MULTI-UNIT ABUTMENT

Angulation	Indication	Gingival Height (mm)	ø3.0	NP ø3.5	RP ø4.3
0°		1.5	-	IPD/AD-MN-01	IPD/AD-MR-01
		2.5	-	IPD/AD-MN-02	IPD/AD-MR-02
		3.5	-	IPD/AD-MN-03	IPD/AD-MR-03
		4.5	-	IPD/AD-MN-04	IPD/AD-MR-04
17°		2.5	-	IPD/AD-MN-12	IPD/AD-MR-12
		3.5	-	IPD/AD-MN-13	IPD/AD-MR-13
30°		3.5	-	IPD/AD-MN-33	IPD/AD-MR-33
		4.5	-	IPD/AD-MN-34	IPD/AD-MR-34
		Replacement Screw for Angled MUA	-	IPD/KA-MT-02	IPD/KA-MT-03

Straight Multi-unit abutments can be used for single and multiple restorations. Please see page 206 for the Multi-unit system accessories.

MULTI-UNIT AP ABUTMENT* **NEW**

*Check availability

Angulation	Indication	Gingival Height (mm)	ø3.0	NP ø3.5	RP ø4.3
17°		2.5	-	IPD/AD-MN-12/AP	IPD/AD-MR-12/AP
		3.5	-	IPD/AD-MN-13/AP	IPD/AD-MR-13/AP
30°		3.5	-	IPD/AD-MN-33/AP	IPD/AD-MR-33/AP
		4.5	-	IPD/AD-MN-34/AP	IPD/AD-MR-34/AP
	Replacement Screw for Angled MUA AP	-	-	IPD/KA-MT-02/BLC	IPD/KA-MT-03/BLC

Please see page 206 for the Multi-unit system accessories.



ANALOGS

Type	ø3.0	NP ø3.5	RP ø4.3
Standard	IPD/AD-AT-00	IPD/AD-AN-00	IPD/AD-AR-00
	Full set	IPD/AD-AT-90/3D	IPD/AD-AN-90/3D
Digital			
		Analog	
		Bottom Screw	
		Side Screw	



Co-Cr BASE ABUTMENT

		ø3.0	NP ø3.5	RP ø4.3
Co-Cr Base for analogic workflow				
Indication	Angulation			
	0°	IPD/AD-BT-00	IPD/AD-BN-00	IPD/AD-BR-00
	15°	IPD/AD-BT-10	IPD/AD-BN-10	IPD/AD-BR-10
	25°	IPD/AD-BT-20	IPD/AD-BN-20	IPD/AD-BR-20
	0°	IPD/AD-BT-01	IPD/AD-BN-01	IPD/AD-BR-01
	15°	IPD/AD-BT-11	IPD/AD-BN-11	IPD/AD-BR-11
	25°	IPD/AD-BT-21	IPD/AD-BN-21	IPD/AD-BR-21
Co-Cr Base for digital workflow				
Indication	Angulation			
	Straight	IPD/AD-BT-00/3D	IPD/AD-BN-00/3D	IPD/AD-BR-00/3D
	ASC	IPD/AD-BT-A0/3D	IPD/AD-BN-00/3D	IPD/AD-BR-A0/3D
	Straight	IPD/AD-BT-01/3D	IPD/AD-BN-01/3D	IPD/AD-BR-01/3D
	ASC	IPD/AD-BT-A1/3D	IPD/AD-BN-01/3D	IPD/AD-BR-A1/3D
	Scan Body	IPD/SC-AN-B1	IPD/SC-AN-B1	IPD/SC-AN-B1

All ASC CoCr analogic workflow abutments include the relevant TPA screw.



CASTABLE ABUTMENT

Indication	ø3.0	NP ø3.5	RP ø4.3
	-	-	IPD/AD-HR-00
	-	-	IPD/AD-RR-00



PSD OVERDENTURE ABUTMENT

Indication	Gingival Height (mm)	ø3.0	NP ø3.5	RP ø4.3
	1.0	-	IPD/AD-LN-01	IPD/AD-LR-01
	2.0	-	IPD/AD-LN-02	IPD/AD-LR-02
	3.0	-	IPD/AD-LN-03	IPD/AD-LR-03
	4.0	-	IPD/AD-LN-04	IPD/AD-LR-04
	5.0	-	IPD/AD-LN-05	IPD/AD-LR-05

Please see page 205 for the PSD system accessories.





COPING ABUTMENT

Type	ø3.0	NP ø3.5	RP ø4.3
Open tray	IPD/AD-CT-00	-	-

Classic Design



TEMPORARY ABUTMENT / OPEN TRAY COPING

Indication	Gingival Height (mm)	ø3.0	NP ø3.5	RP ø4.3
	1.5	IPD/AD-PT-06	IPD/AD-PN-06	IPD/AD-PR-06
	1.5	IPD/AD-PT-07	IPD/AD-PN-07	IPD/AD-PR-07
Long coping screw		IPD/AD-TT-00/C	IPD/AD-TN-00/C	IPD/AD-TR-00/C

The same abutment can be used as a temporary abutment with the occlusal screw or as an impression coping using the coping screw.



HEALING ABUTMENT

Gingival Height (mm)	Head Diameter (mm)	ø3.0	NP ø3.5	RP ø4.3
Sealing cap		-	IPD/AD-DN-00	IPD/AD-DR-00
Head Diameter (mm)		ø3.1	ø3.6	ø5.0
1.5	-	IPD/AD-DN-01	IPD/AD-DR-01	
3.0	IPD/AD-DT-03	IPD/AD-DN-03	IPD/AD-DR-03	
5.0	IPD/AD-DT-05	IPD/AD-DN-05	IPD/AD-DR-05	
7.0	IPD/AD-DT-07	-	-	
Head Diameter (mm)		ø5.0		
3.0 wide	-	IPD/AD-DN-13	-	
5.0 wide	-	IPD/AD-DN-15	-	



SCREWDRIVERS

Type	Length (mm)	ø3.0	NP ø3.5	RP ø4.3
Implant system Screwdriver				
Unigrip	18	IPD/PU-00-18	IPD/PU-00-18	IPD/PU-00-18
	25	IPD/PU-00-25	IPD/PU-00-25	IPD/PU-00-25
	32	IPD/PU-00-32	IPD/PU-00-32	IPD/PU-00-32
IPD Scan Body and extra Screwdrivers				
1.20 Hex	18	IPD/PH-20-18	IPD/PH-20-18	IPD/PH-20-18
	25	IPD/PH-20-25	IPD/PH-20-25	IPD/PH-20-25
	32	IPD/PH-20-32	IPD/PH-20-32	IPD/PH-20-32
	32	IPD/PH-20-32	IPD/PH-20-32	IPD/PH-20-32
ASC Screwdriver				
TPA	18	IPD/KA-CT-18	IPD/KA-CT-18	IPD/KA-CT-18
	25	IPD/KA-CT-25	IPD/KA-CT-25	IPD/KA-CT-25
	32	IPD/KA-CT-32	IPD/KA-CT-32	IPD/KA-CT-32
PSD Screwdriver				
PSD	25	-	IPD/LL-PS-00	IPD/LL-PS-00



ACCESSORIES

Indication	Length (mm)	ø3.0	NP ø3.5	RP ø4.3
Clinical RA Shank Handle	16	IPD/MC-00-16	IPD/MC-00-16	IPD/MC-00-16
Laboratory RA Shank Handle	70	IPD/ML-00-70	IPD/ML-00-70	IPD/ML-00-70
RA Shank Ratchet	90	IPD/DI-00-90	IPD/DI-00-90	IPD/DI-00-90
Ratchet adapter	-	IPD/DI-KA-90	IPD/DI-KA-90	IPD/DI-KA-90
PSD and insert extractor tool	-	-	IPD/LL-PS-01	IPD/LL-PS-01

Please see page 210 for more information.





BIOMET® 3i®

BA OSSEOTITE®

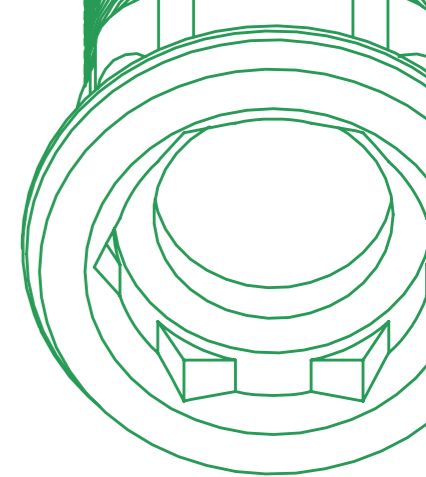
Prosthetic Platform [NP ø3.4 / RP ø4.1 / WP ø5.0]





SCAN BODY

Indication	Height (mm)	NP ø3.4	RP ø4.1	WP ø5.0
	10	IPD/BA-SN-00	IPD/AA-SR-00	IPD/BA-SW-00
	15	IPD/BA-SN-02	IPD/AA-SR-02	IPD/BA-SW-02
	10	IPD/BA-SN-01	IPD/AA-SR-01	IPD/BA-SW-01

Captive screw included. 1.20 Hex Screwdriver.



Ti-BASE 

Indication	Gingival Height (mm)	NP ø3.4	RP ø4.1	WP ø5.0
	0.5	-	IPD/AA-IR-00/3D	IPD/BA-IW-00/3D
	1.5	IPD/BA-IN-02/3D	IPD/AA-IR-02/3D	IPD/BA-IW-02/3D
	2.5	-	IPD/AA-IR-04/3D	-
Cutting guide KIT		IPD/KT-IN-00	IPD/KT-IR-00	IPD/KT-IW-00
	0.5	-	IPD/AA-IR-01/3D	IPD/BA-IW-01/3D
	1.5	IPD/BA-IN-03/3D	IPD/AA-IR-03/3D	IPD/BA-IW-03/3D
	2.5	-	IPD/AA-IR-05/3D	-
Cutting guide KIT		IPD/KT-IN-01	IPD/KT-IR-01	IPD/KT-IW-01

Please see page 204 for the IPD Custom Interface System accessories.



IPDMILLED SYSTEM* 

*Check availability

Indication	Material	Diameter (mm)	NP ø3.4	RP ø4.1	WP ø5.0
TYPE A System (Compatible with DESS® Holders)					
	Ti	15	PR/BA-XN-15/A	PR/AA-XR-15/A	PR/BA-XW-15/A

All premilled abutments include 2 titanium screws.



RETURN TO INDEX

SCREWS

			NP ø3.4	RP ø4.1	WP ø5.0
IPD and OEM compatible	For straight channels	Torque value	25 Ncm	25 Ncm	25 Ncm
Screwdriver	Coating	Seat			
1.20 Hex	-	Conical	IPD/BA-TR-00	IPD/BA-TR-00	IPD/BA-TR-00
1.20 Hex	TiN	Conical	IPD/BA-TR-00/TiN	IPD/BA-TR-00/TiN	IPD/BA-TR-00/TiN
1.20 Hex	BLC	Conical	IPD/BA-TR-00/BLC	IPD/BA-TR-00/BLC	IPD/BA-TR-00/BLC
		Torque value	25 Ncm	25 Ncm	25 Ncm
Screwdriver	Coating	Seat			
TPA	TiN	Conical	IPD/AA-TR-50	IPD/AA-TR-50	IPD/AA-TR-50
Additional options					
		Torque value	20 Ncm	20 Ncm	20 Ncm
Screwdriver	Coating	Seat			
1.20 Hex	-	Low profile head - conical seat	IPD/AA-TR-01	IPD/AA-TR-01	IPD/AA-TR-01
1.20 Hex	TiN	Low profile head - conical seat	IPD/AA-TR-01/TiN	IPD/AA-TR-01/TiN	IPD/AA-TR-01/TiN
1.20 Hex	BLC	Low profile head - conical seat	IPD/AA-TR-01/BLC	IPD/AA-TR-01/BLC	IPD/AA-TR-01/BLC
		Torque value	25 Ncm	25 Ncm	25 Ncm
Screwdriver	Coating	Seat			
1.25 Hex	-	Conical	IPD/BA-TR-01	IPD/BA-TR-01	IPD/BA-TR-01
1.25 Hex	TiN	Conical	IPD/BA-TR-01/TiN	IPD/BA-TR-01/TiN	IPD/BA-TR-01/TiN
1.25 Hex	BLC	Conical	IPD/BA-TR-01/BLC	IPD/BA-TR-01/BLC	IPD/BA-TR-01/BLC
		Torque value	35 Ncm	35 Ncm	35 Ncm
Screwdriver	Coating	Seat			
Square	-	Flat	IPD/BA-TR-02	IPD/BA-TR-02	IPD/BA-TR-02
Square	TiN	Flat	IPD/BA-TR-02/TiN	IPD/BA-TR-02/TiN	IPD/BA-TR-02/TiN
Square	BLC	Flat	IPD/BA-TR-02/BLC	IPD/BA-TR-02/BLC	IPD/BA-TR-02/BLC
		Torque value	25 Ncm	25 Ncm	25 Ncm
Screwdriver	Coating	Seat			
TPA	TiN	For implant level flat seat	IPD/AA-TR-52	IPD/AA-TR-52	IPD/AA-TR-52



MULTI-UNIT ABUTMENT

Angulation	Indication	Gingival Height (mm)	NP ø3.4	RP ø4.1	WP ø5.0
0°		1.0	-	IPD/AB-MR-01	-
		2.0	-	IPD/AB-MR-02	-
		3.0	-	IPD/AB-MR-03	-
		4.0	-	IPD/AB-MR-04	-
		5.0	-	IPD/AB-MR-05	-
17°		2.0	-	IPD/AB-MR-12	-
		3.0	-	IPD/AB-MR-13	-
		4.0	-	IPD/AB-MR-14	-
30°		3.0	-	IPD/AB-MR-33	-
		4.0	-	IPD/AB-MR-34	-
		5.0	-	IPD/AB-MR-35	-
		Replacement Screw for Angled MUA		-	IPD/KA-MT-00



Straight Multi-unit abutments can be used for single and multiple restorations. Please see page 206 for the Multi-unit system accessories.

ANALOGS

Type		NP ø3.4	RP ø4.1	WP ø5.0
Standard		IPD/BA-AN-00	IPD/AA-AR-00	IPD/BA-AW-00
	Full set	IPD/BA-AN-90/3D	IPD/AA-AR-90/3D	IPD/BA-AW-90/3D
Digital	Analogue			
	Bottom Screw			
	Side Screw			



Co-Cr BASE ABUTMENT

		NP ø3.4	RP ø4.1	WP ø5.0
Co-Cr Base for analogic workflow				
Indication	Angulation			
	0°	IPD/BA-BN-00	IPD/AA-BR-00	IPD/BA-BW-00
	15°	IPD/BA-BN-10	IPD/AA-BR-10	IPD/BA-BW-10
	25°	IPD/BA-BN-20	IPD/AA-BR-20	IPD/BA-BW-20
	0°	IPD/BA-BN-01	IPD/AA-BR-01	IPD/BA-BW-01
	15°	IPD/BA-BN-11	IPD/AA-BR-11	IPD/BA-BW-11
	25°	IPD/BA-BN-21	IPD/AA-BR-21	IPD/BA-BW-21
Co-Cr Base for digital workflow				
Indication	Angulation			
	Straight/ASC	IPD/BA-BN-00/3D	IPD/AA-BR-00/3D	IPD/BA-BW-00/3D
	Straight/ASC	IPD/BA-BN-01/3D	IPD/AA-BR-01/3D	IPD/BA-BW-01/3D
		Scan Body	IPD/SC-AN-B1	IPD/SC-AN-B1



All ASC CoCr analogic workflow abutments include the relevant TPA screw.

CASTABLE ABUTMENT

Indication		NP ø3.4	RP ø4.1	WP ø5.0
		-	IPD/AA-HR-00	IPD/BA-HW-00
		-	IPD/AA-RR-00	IPD/BA-RW-00



PSD OVERDENTURE ABUTMENT

Indication	Gingival Height (mm)	NP ø3.4	RP ø4.1	WP ø5.0
	1.0	IPD/BA-LN-01	IPD/AA-LR-01	-
	2.0	-	IPD/AA-LR-02	-
	3.0	IPD/BA-LN-03	IPD/AA-LR-03	-
	4.0	-	IPD/AA-LR-04	-
	5.0	-	IPD/AA-LR-05	-

Please see page 205 for the PSD system accessories.





COPING ABUTMENT

Type		NP ø3.4	RP ø4.1	WP ø5.0
Open tray		-	IPD/AA-CR-00	IPD/BA-CW-00
Closed tray		-	IPD/AA-CR-01	-

Classic Design



TEMPORARY ABUTMENT / OPEN TRAY COPING



Indication	Gingival Height (mm)	NP ø3.4	RP ø4.1	WP ø5.0
	1.5	IPD/BA-PN-06	IPD/AA-PR-06	IPD/BA-PW-06
	1.5	IPD/BA-PN-07	IPD/AA-PR-07	IPD/BA-PW-07
Long coping screw		IPD/AA-TR-00/C	IPD/AA-TR-00/C	IPD/AA-TR-00/C

The same abutment can be used as a temporary abutment with the occlusal screw or as an impression coping using the coping screw.

HEALING ABUTMENT

Gingival Height (mm)	Head Diameter (mm)	NP ø3.4	RP ø4.1	WP ø5.0
2.0		IPD/BA-DN-02	IPD/AA-DR-02	IPD/BA-DW-02
3.0		IPD/BA-DN-03	IPD/AA-DR-03	IPD/BA-DW-03
4.0		IPD/BA-DN-04	IPD/AA-DR-04	IPD/BA-DW-04
5.0		-	IPD/AA-DR-05	-

TI CEMENT-RETAINED ABUTMENT

Indication	Angulation	Gingival Height	NP ø3.4	RP ø4.1	WP ø5.0
	0°	2.0	-	IPD/AA-PR-00	-
	15°	1.0	-	IPD/AA-PR-02	-
		2.0	-	IPD/AA-PR-04	-
	25°	1.0	-	IPD/AA-PR-03	-
2.0		-	IPD/AA-PR-05	-	
	0°	-	-	IPD/AA-PR-01	-

Using the Low profile IPD/AA-TR-01 screw for IPD/AA-PR-04 is recommended

SCREWDRIVERS

Type	Length (mm)	NP ø3.4	RP ø4.1	WP ø5.0
Implant system Screwdriver				
1.20 Hex	18	IPD/PH-20-18	IPD/PH-20-18	IPD/PH-20-18
	25	IPD/PH-20-25	IPD/PH-20-25	IPD/PH-20-25
	32	IPD/PH-20-32	IPD/PH-20-32	IPD/PH-20-32
1.25 Hex	18	IPD/PH-25-18	IPD/PH-25-18	IPD/PH-25-18
	25	IPD/PH-25-25	IPD/PH-25-25	IPD/PH-25-25
Square	18	IPD/PC-25-18	IPD/PC-25-18	IPD/PC-25-18
	25	IPD/PC-25-25	IPD/PC-25-25	IPD/PC-25-25
ASC Screwdriver				
TPA	18	IPD/KA-CT-18	IPD/KA-CT-18	IPD/KA-CT-18
	25	IPD/KA-CT-25	IPD/KA-CT-25	IPD/KA-CT-25
	32	IPD/KA-CT-32	IPD/KA-CT-32	IPD/KA-CT-32
PSD Screwdriver				
PSD	25	IPD/LL-PS-00	IPD/LL-PS-00	IPD/LL-PS-00

ACCESSORIES

Indication	Length (mm)	NP ø3.4	RP ø4.1	WP ø5.0
Clinical RA Shank Handle	16	IPD/MC-00-16	IPD/MC-00-16	IPD/MC-00-16
Laboratory RA Shank Handle	70	IPD/ML-00-70	IPD/ML-00-70	IPD/ML-00-70
RA Shank Ratchet	90	IPD/DI-00-90	IPD/DI-00-90	IPD/DI-00-90
Ratchet adapter		IPD/DI-KA-90	IPD/DI-KA-90	IPD/DI-KA-90
PSD and insert extractor tool		IPD/LL-PS-01	IPD/LL-PS-01	IPD/LL-PS-01

Please see page 210 for more information.



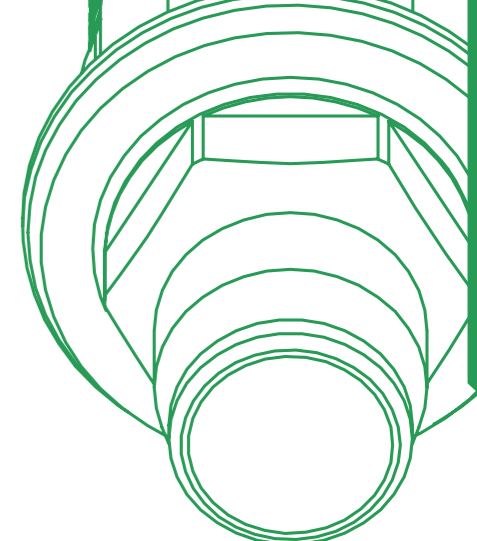

BIOMET® 3i®

BB OSSEOTITE® CERTAIN® Prosthetic Platform [NP ø3.4 / RP ø4.1 / WP ø5.0]





SCAN BODY

Indication	Height (mm)	NP ø3.4	RP ø4.1	WP ø5.0
	10	IPD/BB-SN-00	IPD/BB-SR-00	IPD/BB-SW-00
	15	IPD/BB-SN-02	IPD/BB-SR-02	IPD/BB-SW-02
	10	IPD/BB-SN-01	IPD/BB-SR-01	IPD/BB-SW-01

Captive screw included 1.20 Hex Screwdriver.



Ti-BASE  Custom Ti-Base System®

Indication	Gingival Height (mm)	NP ø3.4	RP ø4.1	WP ø5.0
	0.5	IPD/BB-IN-00/3D	IPD/BB-IR-00/3D	IPD/BB-IW-00/3D
	1.5	IPD/BB-IN-02/3D	IPD/BB-IR-02/3D	IPD/BB-IW-02/3D
	2.5	IPD/BB-IN-04/3D	IPD/BB-IR-04/3D	-
Cutting guide KIT		IPD/KT-IN-00	IPD/KT-IR-00	IPD/KT-IW-00
	0.5	IPD/BB-IN-01/3D	IPD/BB-IR-01/3D	IPD/BB-IW-01/3D
	1.5	IPD/BB-IN-03/3D	IPD/BB-IR-03/3D	IPD/BB-IW-03/3D
	2.5	IPD/BB-IN-05/3D	IPD/BB-IR-05/3D	-
Cutting guide KIT		IPD/KT-IN-01	IPD/KT-IR-01	IPD/KT-IW-01

Please see page 204 for the IPD Custom Interface System accessories.



IPDMILLED SYSTEM* 

*Check availability

Indication	Material	Diameter (mm)	NP ø3.4	RP ø4.1	WP ø5.0
IPD Blank System (Compatible with NT/IPD Holders)					
	Ti	12	IPD/BB-XN-00	IPD/BB-XR-00	IPD/BB-XW-00
Mill Analog			IPD/BB-AN-00/X	IPD/BB-AR-00/X	IPD/BB-AW-00/X
TYPE A System (Compatible with DESS® Holders)					
	Ti	15	PR/BB-XN-15/A	PR/BB-XR-15/A	PR/BB-XW-15/A

All premilled abutments include 2 titanium screws.



RETURN TO INDEX

SCREWS

			NP ø3.4	RP ø4.1	WP ø5.0
IPD and OEM compatible	For straight channels	Torque value	20 Ncm	20 Ncm	20 Ncm
Screwdriver	Coating	Seat			
1.20 Hex	-	Flat	IPD/BB-TR-01	IPD/BB-TR-01	IPD/BB-TR-01
1.20 Hex	TiN	Flat	IPD/BB-TR-01/TiN	IPD/BB-TR-01/TiN	IPD/BB-TR-01/TiN
1.20 Hex	BLC	Flat	IPD/BB-TR-01/BLC	IPD/BB-TR-01/BLC	IPD/BB-TR-01/BLC
For ASC options			20 Ncm	20 Ncm	20 Ncm
Screwdriver	Coating	Seat			
TPA	TiN	Flat	IPD/BB-TR-51	IPD/BB-TR-51	IPD/BB-TR-51
Additional options			20 Ncm	20 Ncm	20 Ncm
Screwdriver	Coating	Seat			
1.20 Hex	-	Conical	-	IPD/BB-TR-02	IPD/BB-TR-02



MULTI-UNIT ABUTMENT

Angulation	Indication	Gingival Height (mm)	NP ø3.4	RP ø4.1	WP ø5.0
0°		1.0	IPD/BB-MN-01	IPD/BB-MR-01	-
		2.0	IPD/BB-MN-02	IPD/BB-MR-02	-
		3.0	IPD/BB-MN-03	IPD/BB-MR-03	-
		4.0	IPD/BB-MN-04	IPD/BB-MR-04	-
		5.0	-	IPD/BB-MR-05	-
17°		2.0	-	IPD/BB-MR-12	-
		3.0	-	IPD/BB-MR-13	-
30°		4.0	-	IPD/BB-MR-34	-
		5.0	-	IPD/BB-MR-35	-
		Replacement Screw for Angled MUA	-	IPD/KA-MT-02	-

Straight Multi-unit abutments can be used for single and multiple restorations. Please see page 206 for the Multi-unit system accessories.



ANALOGS

Type		NP ø3.4	RP ø4.1	WP ø5.0
Standard		IPD/BB-AN-00	IPD/BB-AR-00	IPD/BB-AW-00
	Full set	IPD/BB-AN-90/3D	IPD/BB-AR-90/3D	IPD/BB-AW-90/3D
Digital	Analog			
	Bottom Screw			
	Side Screw			



Co-Cr BASE ABUTMENT

		NP ø3.4	RP ø4.1	WP ø5.0
Co-Cr Base for analogic workflow				
Indication	Angulation			
	0°	IPD/BB-BN-00	IPD/BB-BR-00	-
	15°	IPD/BB-BN-10	IPD/BB-BR-10	-
	25°	IPD/BB-BN-20	IPD/BB-BR-20	-
	0°	IPD/BB-BN-01	IPD/BB-BR-01	-
	15°	IPD/BB-BN-11	IPD/BB-BR-11	-
	25°	IPD/BB-BN-21	IPD/BB-BR-21	-
Co-Cr Base for digital workflow				
Indication	Angulation			
	Straight	IPD/BB-BN-00/3D	IPD/BB-BR-00/3D	
	ASC	IPD/BB-BN-A0/3D	IPD/BB-BR-A0/3D	
	Straight	IPD/BB-BN-01/3D	IPD/BB-BR-01/3D	
	ASC	IPD/BB-BN-A1/3D	IPD/BB-BR-A1/3D	
Scan Body		IPD/SC-AN-B1	IPD/SC-AN-B1	

All ASC CoCr analogic workflow abutments include the relevant TPA screw.



CASTABLE ABUTMENT

Indication	NP ø3.4	RP ø4.1	WP ø5.0
	-	IPD/BB-HR-00	IPD/BB-HW-00
	-	IPD/BB-RR-00	IPD/BB-RW-00



PSD OVERDENTURE ABUTMENT

Indication	Gingival Height (mm)	NP ø3.4	RP ø4.1	WP ø5.0
	1.0	IPD/BB-LN-01	IPD/BB-LR-01	-
	3.0	IPD/BB-LN-03	IPD/BB-LR-03	-
	5.0	IPD/BB-LN-05	IPD/BB-LR-05	-

Please see page 205 for the PSD system accessories.



COPING ABUTMENT

Type	NP ø3.4	RP ø4.1	WP ø5.0
Open tray	-	-	IPD/BB-CW-00
Classic Design			



TEMPORARY ABUTMENT / OPEN TRAY COPING

Indication	Gingival Height (mm)	NP ø3.4	RP ø4.1	WP ø5.0
	1.5	IPD/BB-PN-06	IPD/BB-PR-06	IPD/BB-PW-06
	1.5	IPD/BB-PN-07	IPD/BB-PR-07	IPD/BB-PW-07
Long coping screw		IPD/BB-TR-01/C	IPD/BB-TR-01/C	IPD/BB-TR-01/C

The same abutment can be used as a temporary abutment with the occlusal screw or as an impression coping using the coping screw.



HEALING ABUTMENT

Gingival Height (mm)		NP ø3.4	RP ø4.1	WP ø5.0
	Head Diameter (mm)	ø3.5	ø4.1	ø5.0
2.0		IPD/BB-DN-02	IPD/BB-DR-02	IPD/BB-DW-02
3.0		IPD/BB-DN-03	IPD/BB-DR-03	IPD/BB-DW-03
4.0		IPD/BB-DN-04	IPD/BB-DR-04	IPD/BB-DW-04



TI CEMENT-RETAINED ABUTMENT

Indication	Angulation	Gingival Height	NP ø3.4	RP ø4.1	WP ø5.0
	0°	2.0	IPD/BB-PN-00	IPD/BB-PR-00	IPD/BB-PW-00



SCREWDRIVERS

Type	Length (mm)	NP ø3.4	RP ø4.1	WP ø5.0
Implant system Screwdriver				
	18	IPD/PH-20-18	IPD/PH-20-18	IPD/PH-20-18
1.20 Hex	25	IPD/PH-20-25	IPD/PH-20-25	IPD/PH-20-25
	32	IPD/PH-20-32	IPD/PH-20-32	IPD/PH-20-32
ASC Screwdriver				
	18	IPD/KA-CT-18	IPD/KA-CT-18	IPD/KA-CT-18
TPA	25	IPD/KA-CT-25	IPD/KA-CT-25	IPD/KA-CT-25
	32	IPD/KA-CT-32	IPD/KA-CT-32	IPD/KA-CT-32
PSD Screwdriver				
PSD	25	IPD/LL-PS-00	IPD/LL-PS-00	IPD/LL-PS-00



ACCESSORIES

Indication	Length (mm)	NP ø3.4	RP ø4.1	WP ø5.0
Clinical RA Shank Handle	16	IPD/MC-00-16	IPD/MC-00-16	IPD/MC-00-16
Laboratory RA Shank Handle	70	IPD/ML-00-70	IPD/ML-00-70	IPD/ML-00-70
RA Shank Ratchet	90	IPD/DI-00-90	IPD/DI-00-90	IPD/DI-00-90
Ratchet adapter		IPD/DI-KA-90	IPD/DI-KA-90	IPD/DI-KA-90
PSD and insert extractor tool		IPD/LL-PS-01	IPD/LL-PS-01	IPD/LL-PS-01

Please see page 210 for more information.



BIOMET® 3i®

BC LOW PROFILE ABUTMENT

Prosthetic Platform [RP ø4.8]

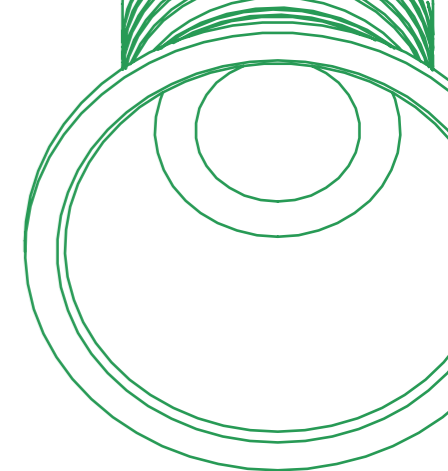

SCAN BODY / SCAN DATA MARKER

	Indication	Height (mm)	RP ø4.8
Scan Body		10	IPD/BC-SR-00
		10	IPD/BC-SR-01
One Shot IQ		6	IPD/BC-SR-03
Reverse IQ			IPD/BC-SR-00/RS

Captive screw included except on Reverse Marker IQ. 1.20 Hex Screwdriver



SCANLOGIQ® FULL ARCH SYSTEM*

*Check availability

		RP ø4.8
ScanLogIQ® KIT	ScanLogIQ® Box	IPD/BC-KR-00/FS
		1 Scan Flag IQ Set 6 One Shot IQ 6 Reverse Marker IQ 1 Control Plate IQ 1 Screwdriver 1 Clinical Handle
Scan Flag IQ SET		IPD/BC-KR-01/FS
		3 Short 3 Medium 4 Large 0° 2 Large +20° 2 Large -20°
Control Plate IQ		IPD/KT-FS-00

Captive screw IPD/AB-TR-00/FS included on all Scan Flag IQ. 1.25 Hex Screwdriver.



Ti-BASE Custom Ti-Base System®

Indication	Post Height (mm)	Gingival Height (mm)	RP ø4.8
	4.25	0.5	IPD/BC-IR-00/3D
	6.5	0.5	IPD/BC-IR-02/3D
	4.6	0.2	IPD/BC-IR-01/3D
	6.5	0.2	IPD/BC-IR-03/3D



RETURN TO INDEX

SCREWS

			RP ø4.8
IPD and OEM compatible	For straight channels	Torque value	15 Ncm
Screwdriver	Coating	Seat	
1.20 Hex	-	Flat	IPD/BC-TR-00
1.20 Hex	TiN	Flat	IPD/BC-TR-00/TiN
1.20 Hex	BLC	Flat	IPD/BC-TR-00/BLC
For ASC options			15 Ncm
Screwdriver	Coating	Indication	
TPA	TiN	For PH 4.0 mm Ti-bases	IPD/BC-TR-50
TPA	TiN	For PH 6.5 mm Ti-bases	IPD/BC-TR-51



ANALOGS

Type		RP ø4.8
Standard		IPD/BC-AR-00
Digital	Full set	IPD/BC-AR-90/3D



PSD OVERDENTURE ABUTMENT

Indication	Gingival Height (mm)		RP ø4.8
	3.35	2 units pack	IPD/BC-LR-02

Please see page 205 for the PSD system accessories.



TEMPORARY ABUTMENT / OPEN TRAY COPING

Indication	Gingival Height (mm)		RP ø4.8
	0.5		IPD/BC-PR-06
	0.2		IPD/BC-PR-07
		Long coping screw	IPD/BC-TR-00/C

The same abutment can be used as a temporary abutment with the occlusal screw or as an impression coping using the coping screw.



HEALING ABUTMENT

Gingival Height (mm)		RP ø4.8
	Head Diameter (mm)	Bottom ø5.0 - Top ø3.67
4.45		IPD/BC-DR-04
	Screw	IPD/BC-TR-00

Screw not included



SCREWDRIVERS

Type	Length (mm)	RP ø4.8
Implant system Screwdriver		
IPD Scan Body and extra Screwdrivers		
	18	IPD/PH-20-18
1.20 Hex	25	IPD/PH-20-25
	32	IPD/PH-20-32
ASC Screwdriver		
	18	IPD/KA-CT-18
TPA	25	IPD/KA-CT-25
	32	IPD/KA-CT-32
PSD Screwdriver		
PSD	25	IPD/LL-PS-00



ACCESSORIES

Indication	Length (mm)	RP ø4.8
Clinical RA Shank Handle	16	IPD/MC-00-16
Laboratory RA Shank Handle	70	IPD/ML-00-70
RA Shank Ratchet	90	IPD/DI-00-90
Ratchet adapter	-	IPD/DI-KA-90
PSD and insert extractor tool		IPD/LL-PS-01

Please see page 210 for more information.



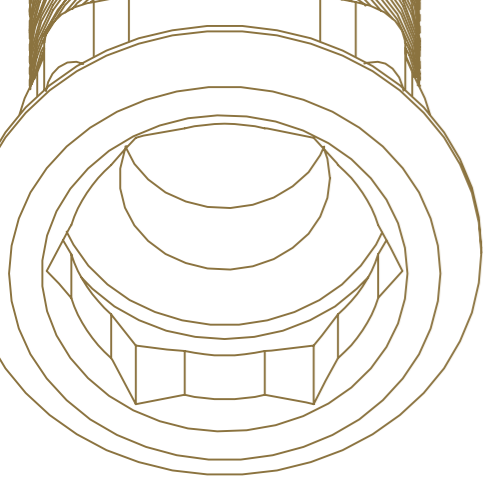

KLOCKNER®

CA SK2-NK2 Prosthetic Platform [RP ø4.2]

SCAN BODY / SCAN DATA MARKER

	Indication	Height (mm)	RP ø4.2
Scan Body		10	IPD/CA-SR-00
		10	IPD/CA-SR-01

Captive screw included 1.20 Hex Screwdriver.

Ti-BASE Custom Ti-Base System®

Indication	Gingival Height (mm)	RP ø4.2
	0.5	IPD/CA-IR-00/3D ¹
	2.25	IPD/CA-IR-04/3D ²
		¹ IPD/KT-IW-00 (no ASC)
		² IPD/KT-IR-00
	0.5	IPD/CA-IR-01/3D*
	2.25	IPD/CA-IR-05/3D
	Cutting guide KIT	IPD/KT-IR-01

Please see page 204 for the IPD Custom Interface System accessories.
*Only available Post Height 3.5 mm version

SCREWS

IPD and OEM compatible		Torque value	RP ø4.2
For straight channels		30 Ncm	
Screwdriver	Coating	Seat	
1.70 Hex	-	Conical	IPD/CA-TR-00
1.70 Hex	TiN	Conical	IPD/CA-TR-00/TiN
1.70 Hex	BLC	Conical	IPD/CA-TR-00/BLC
		Torque value	30 Ncm
Screwdriver	Coating	Seat	
Cruciform	-	Conical	IPD/CA-TR-01
Cruciform	TiN	Conical	IPD/CA-TR-01/TiN
		Torque value	25 Ncm
Screwdriver	Coating	Seat	
For ASC options		25 Ncm	
TPA	TiN	Conical	IPD/CA-TR-50



[RETURN TO INDEX](#)

ANALOGS

Type	RP ø4.2
Standard	IPD/CA-AR-00
Full set	IPD/CA-AR-90/3D
Digital	Analog
	Bottom Screw
	Side Screw



Co-Cr BASE ABUTMENT

Co-Cr Base for analogic workflow		RP ø4.2
Indication	Angulation	
	0°	IPD/CA-BR-00
	15°	IPD/CA-BR-10
	25°	IPD/CA-BR-20
	0°	IPD/CA-BR-01
	15°	IPD/CA-BR-11
	25°	IPD/CA-BR-21
Co-Cr Base for digital workflow		
Indication	Angulation	
	Straight/ASC	IPD/CA-BR-00/3D
	Straight/ASC	IPD/CA-BR-01/3D
	Scan Body	IPD/SC-AN-B1

All ASC CoCr analogic workflow abutments include the relevant TPA screw.



CASTABLE ABUTMENT

Indication	RP ø4.2
	IPD/CA-HR-00
	IPD/CA-RR-00



TEMPORARY ABUTMENT / OPEN TRAY COPING

Indication	Gingival Height (mm)	RP ø4.2
	1.5	IPD/CA-PR-06
	1.5	IPD/CA-PR-07
	Long coping screw	IPD/CA-TR-00/C

The same abutment can be used as a temporary abutment with the occlusal screw or as an impression coping using the coping screw.



HEALING ABUTMENT

Gingival Height (mm)	Head Diameter (mm)	RP ø4.2
5.5	ø5.2	IPD/CA-DR-00
	Screw	IPD/CA-TR-00

Screw not included



TI CEMENT-RETAINED ABUTMENT

Indication	Angulation	Gingival Height	RP ϕ 4.2
	0°	0.2	IPD/CA-PR-00

Using the Low profile IPD/AA-TR-01 screw for IPD/AA-PR-04 is recommended



SCREWDRIVERS

Type	Length (mm)	RP ϕ 4.2
Implant system Screwdriver		
1.70 Hex	18	IPD/PH-70-18
	25	IPD/PH-70-25
	32	IPD/PH-70-32
IPD Scan Body and extra Screwdrivers		
1.20 Hex	18	IPD/PH-20-18
	25	IPD/PH-20-25
	32	IPD/PH-20-32
ASC Screwdriver		
TPA	18	IPD/KA-CT-18
	25	IPD/KA-CT-25
	32	IPD/KA-CT-32



ACCESSORIES

Indication	Length (mm)	RP ϕ 4.2
Clinical RA Shank Handle	16	IPD/MC-00-16
Laboratory RA Shank Handle	70	IPD/ML-00-70
RA Shank Ratchet	90	IPD/DI-00-90
Ratchet adapter	-	IPD/DI-KA-90
PSD and insert extractor tool	-	IPD/LL-PS-01

Please see page 210 for more information.



KLOCKNER®

CB ESSENTIAL CONE® Prosthetic Platform [RP ϕ 4.5]

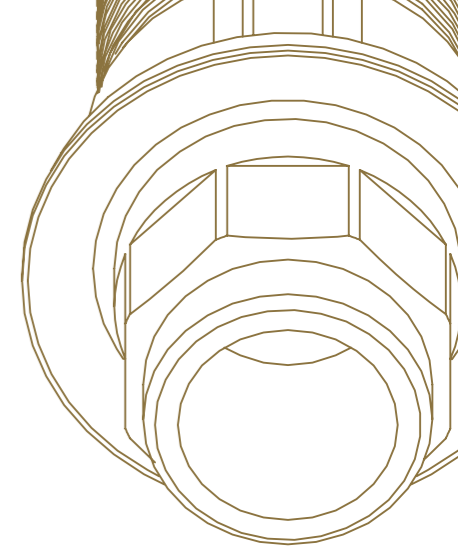

SCAN BODY

Indication	Height (mm)	RP ϕ 4.5
	10	IPD/CB-SR-00
	15	D/CB-SR-02
	10	IPD/CB-SR-01

Captive screw included 1.20 Hex Screwdriver.



Ti-BASE Custom Ti-Base System®

Indication	Gingival Height (mm)	RP ϕ 4.5
	0.5	IPD/CB-IR-00/3D
		Cutting guide KIT IPD/KT-IR-00
	0.5	IPD/CB-IR-01/3D
		Cutting guide KIT IPD/KT-IR-01

Please see page 204 for the IPD Custom Interface System accessories.



SCREWS

IPD and OEM compatible	For straight channels	Torque value	RP ϕ 4.5
		30 Ncm	
Screwdriver	Coating	Seat	
Star	-	Conical	IPD/CB-TR-00
Star	TiN	Conical	IPD/CB-TR-00/TiN
Star	BLC	Conical	IPD/CB-TR-00/BLC
	For ASC options	Torque value	20 Ncm
Screwdriver	Coating	Seat	
TPA	TiN	Conical	IPD/CB-TR-50



ANALOGS

Type	RP ϕ 4.5
Standard	IPD/CB-AR-00
	Full set IPD/CB-AR-90/3D
Digital	Analog Bottom Screw Side Screw



[RETURN TO INDEX](#)

Co-Cr BASE ABUTMENT

RP ϕ 4.5

Co-Cr Base for analogic workflow		
Indication	Angulation	
	0°	IPD/CB-BR-00
	15°	IPD/CB-BR-10
	25°	IPD/CB-BR-20
	0°	IPD/CB-BR-01
	15°	IPD/CB-BR-11
	25°	IPD/CB-BR-21
Co-Cr Base for digital workflow		
Indication	Angulation	
	Straight/ASC	IPD/CB-BR-00/3D
	Straight/ASC	IPD/CB-BR-01/3D
	Scan Body	IPD/SC-AN-B2

All ASC CoCr analogic workflow abutments include the relevant TPA screw.



PSD OVERDENTURE ABUTMENT

RP ϕ 4.5

Indication	Gingival Height (mm)	
	1.0	IPD/CB-LR-01
	3.0	IPD/CB-LR-03
	5.0	IPD/CB-LR-05
	7.0	IPD/CB-LR-07

Please see page 205 for the PSD system accessories.



TEMPORARY ABUTMENT / OPEN TRAY COPING

RP ϕ 4.5

Indication	Gingival Height (mm)	
	1.5	IPD/CB-PR-06
	1.5	IPD/CB-PR-07
	Long coping screw	IPD/CB-TR-00/C

The same abutment can be used as a temporary abutment with the occlusal screw or as an impression coping using the coping screw.



HEALING ABUTMENT

RP ϕ 4.5

Gingival Height (mm)	Head Diameter (mm)	
1.5	ϕ 4.8	IPD/CB-DR-01
3.0		IPD/CB-DR-03
4.5		IPD/CB-DR-04



SCREWDRIVERS

RP ϕ 4.5

Type	Length (mm)	
Implant system Screwdriver		
Star	18	IPD/PS-00-18
	25	IPD/PS-00-25
	32	IPD/PS-00-32
IPD Scan Body and extra Screwdrivers		
1.20 Hex	18	IPD/PH-20-18
	25	IPD/PH-20-25
	32	IPD/PH-20-32
ASC Screwdriver		
TPA	18	IPD/KA-CT-18
	25	IPD/KA-CT-25
	32	IPD/KA-CT-32
PSD Screwdriver		
PSD	25	IPD/LL-PS-00



ACCESSORIES

RP ϕ 4.5

Indication	Length (mm)	
Clinical RA Shank Handle	16	IPD/MC-00-16
Laboratory RA Shank Handle	70	IPD/ML-00-70
RA Shank Ratchet	90	IPD/DI-00-90
Ratchet adapter	-	IPD/DI-KA-90
PSD and insert extractor tool		IPD/LL-PS-01

Please see page 210 for more information.



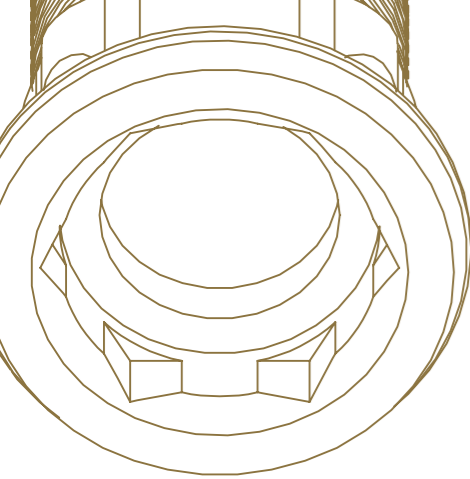

KLOCKNER®

CC KL™

Prosthetic Platform [NP ø3.5 / RP ø4.1 / WP ø5.1]

SCAN BODY

	Indication	Height (mm)	NP ø3.5	RP ø4.1	WP ø5.1
Scan Body		10	IPD/AA-SN-00	IPD/AA-SR-00	IPD/AA-SW-00
		15	IPD/AA-SN-02	IPD/AA-SR-02	-
		10	IPD/AA-SN-01	IPD/AA-SR-01	IPD/AA-SW-01

Captive screw included. 1.20 Hex Screwdriver.



Ti-BASE Custom Ti-Base System®

Indication	Gingival Height (mm)	NP ø3.5	RP ø4.1	WP ø5.1	
	0.5	-	IPD/AA-IR-00/3D	-	
	1.3	-	-	IPD/AA-IW-02/3D	
	1.5	IPD/AA-IN-02/3D	IPD/AA-IR-02/3D	-	
	2.5	-	IPD/AA-IR-04/3D	-	
	Cutting guide KIT		IPD/KT-IN-00	IPD/KT-IR-00	IPD/KT-IW-00
	0.5	-	IPD/AA-IR-01/3D	-	
	1.3	-	-	IPD/AA-IW-03/3D*	
	1.5	IPD/AA-IN-03/3D	IPD/AA-IR-03/3D	-	
	2.5	-	IPD/AA-IR-05/3D	-	
	Cutting guide KIT		IPD/KT-IN-01	IPD/KT-IR-01	-

Please see page 204 for the IPD Custom Interface System accessories.

*Only available Post Height 3.5 mm version



IPDMILLED SYSTEM*

*Check availability

Indication	Material	Diameter (mm)	NP ø3.5	RP ø4.1	WP ø5.1
TYPE A System (Compatible with DESS® Holders)					
	Ti	15	PR/AA-XN-15/A	PR/AA-XR-15/A	PR/AA-XW-15/A

All premilled abutments include 2 titanium screws.



[RETURN TO INDEX](#)

SCREWS

IPD compatible	For straight channels	Torque value	NP ø3.5	RP ø4.1	WP ø5.1
			35 Ncm	35 Ncm	35 Ncm
Screwdriver	Coating	Seat			
Unigrip	-	Conical	IPD/AA-TN-00	IPD/AA-TR-00	IPD/AA-TW-01
Unigrip	TiN	Conical	IPD/AA-TN-00/TiN	IPD/AA-TR-00/TiN	IPD/AA-TW-01/TiN
Unigrip	BLC	Conical	IPD/AA-TN-00/BLC	IPD/AA-TR-00/BLC	IPD/AA-TW-01/BLC

	For ASC options	Torque value	20 Ncm	25 Ncm	25 Ncm
Screwdriver	Coating	Seat			
TPA	TiN	Conical	IPD/AA-TN-50	IPD/AA-TR-50	IPD/AA-TW-50

OEM compatible	Torque value	35 Ncm	35 Ncm	35 Ncm	
Screwdriver	Coating	Seat			
Unigrip	-	Conical	IPD/AA-TN-00	IPD/AA-TR-00	IPD/AA-TW-00
Unigrip	TiN	Conical	IPD/AA-TN-00/TiN	IPD/AA-TR-00/TiN	IPD/AA-TW-00/TiN
Unigrip	BLC	Conical	IPD/AA-TN-00/BLC	IPD/AA-TR-00/BLC	IPD/AA-TW-00/BLC

Additional options	Torque value	35 Ncm	35 Ncm	35 Ncm	
Screwdriver	Coating	Seat			
Unigrip	-	For implant level flat seat	-	IPD/AA-TR-02	-
Unigrip	TiN	For implant level flat seat	-	IPD/AA-TR-02/TiN	-
Unigrip	BLC	For implant level flat seat	-	IPD/AA-TR-02/BLC	-
TPA	TiN	For implant level flat seat	-	IPD/AA-TR-52	-

	Torque value	20 Ncm	20 Ncm	20 Ncm	
1.20 Hex	-	Low profile head - conical seat	-	IPD/AA-TR-01	-
1.20 Hex	TiN	Low profile head - conical seat	-	IPD/AA-TR-01/TiN	-
1.20 Hex	BLC	Low profile head - conical seat	-	IPD/AA-TR-01/BLC	-



MULTI-UNIT ABUTMENT

Angulation	Indication	Gingival Height (mm)	NP ø3.5	RP ø4.1	WP ø5.1
0°		1.0	IPD/AA-MN-01	IPD/AB-MR-01	-
		2.0	IPD/AA-MN-02	IPD/AB-MR-02	-
		3.0	IPD/AA-MN-03	IPD/AB-MR-03	-
		4.0	-	IPD/AB-MR-04	-
		5.0	-	IPD/AB-MR-05	-
17°		2.0	-	IPD/AB-MR-12	-
		3.0	-	IPD/AB-MR-13	-
		4.0	-	IPD/AB-MR-14	-
30°		3.0	-	IPD/AB-MR-33	-
		4.0	-	IPD/AB-MR-34	-
		5.0	-	IPD/AB-MR-35	-
Replacement Screw for Angled MUA			-	IPD/KA-MT-00	-

Straight Multi-unit abutments can be used for single and multiple restorations. Please see page 206 for the Multi-unit system accessories.







ANALOGS

Type	NP ø3.5	RP ø4.1	WP ø5.1	
Standard	IPD/AA-AN-00	IPD/AA-AR-00	IPD/AA-AW-00	
	Full set	IPD/AA-AN-90/3D	IPD/AA-AR-90/3D	IPD/AA-AW-90/3D
Digital		Analogue		
		Bottom Screw		
		Side Screw		





Co-Cr BASE ABUTMENT

		NP ø3.5	RP ø4.1	WP ø5.1
Co-Cr Base for analogic workflow				
Indication	Angulation			
	0°	IPD/AA-BN-00	IPD/AA-BR-00	-
	15°	IPD/AA-BN-10	IPD/AA-BR-10	-
	25°	IPD/AA-BN-20	IPD/AA-BR-20	-
	0°	IPD/AA-BN-01	IPD/AA-BR-01	-
	15°	IPD/AA-BN-11	IPD/AA-BR-11	-
	25°	IPD/AA-BN-21	IPD/AA-BR-21	-
Co-Cr Base for digital workflow				
Indication	Angulation			
	Straight/ASC	IPD/AA-BN-00/3D	IPD/AA-BR-00/3D	-
	Straight/ASC	IPD/AA-BN-01/3D	IPD/AA-BR-01/3D	-
	Scan Body	IPD/SC-AN-B1	IPD/SC-AN-B1	-

All ASC CoCr analogic workflow abutments include the relevant TPA screw.



CASTABLE ABUTMENT

Indication	NP ø3.5	RP ø4.1	WP ø5.1
	-	IPD/AA-HR-00	IPD/AA-HW-00
	-	IPD/AA-RR-00	IPD/AA-RW-00



PSD OVERDENTURE ABUTMENT

Indication	Gingival Height (mm)	NP ø3.5	RP ø4.1	WP ø5.1
	1.0	IPD/AA-LN-01	IPD/AA-LR-01	-
	2.0	-	IPD/AA-LR-02	IPD/RA-LW-02
	3.0	IPD/AA-LN-03	IPD/AA-LR-03	IPD/RA-LW-03
	4.0	-	IPD/AA-LR-04	IPD/RA-LW-04
	5.0	IPD/AA-LN-05	IPD/AA-LR-05	-

Please see page 205 for the PSD system accessories.





COPING ABUTMENT

Type	NP ø3.5	RP ø4.1	WP ø5.1
Open tray	-	IPD/AA-CR-00	IPD/AA-CW-00
Closed tray	-	IPD/AA-CR-01	-

Classic Design



TEMPORARY ABUTMENT / OPEN TRAY COPING

Indication	Gingival Height (mm)	NP ø3.5	RP ø4.1	WP ø5.1
	1.5	IPD/AA-PN-06	IPD/AA-PR-06	IPD/AA-PW-06
	1.5	IPD/AA-PN-07	IPD/AA-PR-07	IPD/AA-PW-07
	Long coping screw	IPD/AA-TN-00/C	IPD/AA-TR-00/C	IPD/AA-TW-00/C

The same abutment can be used as a temporary abutment with the occlusal screw or as an impression coping using the coping screw.



HEALING ABUTMENT

Gingival Height (mm)	Head Diameter (mm)	NP ø3.5	RP ø4.1	WP ø5.1
2.0	ø4.0	IPD/AA-DN-02	IPD/AA-DR-02	IPD/AA-DW-02
3.0	ø4.0	IPD/AA-DN-03	IPD/AA-DR-03	IPD/AA-DW-03
4.0	ø4.0	IPD/AA-DN-04	IPD/AA-DR-04	IPD/AA-DW-04
5.0	ø4.0	-	IPD/AA-DR-05	-



TI CEMENT-RETAINED ABUTMENT

Indication	Angulation	Gingival Height	NP ø3.5	RP ø4.1	WP ø5.1
	0°	2.0	-	IPD/AA-PR-00	-
		1.0	-	IPD/AA-PR-02	-
		2.0	-	IPD/AA-PR-04	-
	25°	1.0	-	IPD/AA-PR-03	-
		2.0	-	IPD/AA-PR-05	-
		2.0	-	IPD/AA-PR-01	-

Using the Low profile IPD/AA-TR-01 screw for IPD/AA-PR-04 is recommended



SCREWDRIVERS

Type	Length (mm)	NP ø3.5	RP ø4.1	WP ø5.1
Implant system Screwdriver				
Unigrip	18	IPD/PU-00-18	IPD/PU-00-18	IPD/PU-00-18
	25	IPD/PU-00-18	IPD/PU-00-18	IPD/PU-00-18
	32	IPD/PU-00-18	IPD/PU-00-18	IPD/PU-00-18
IPD Scan Body and extra Screwdrivers				
1.20 Hex	18	IPD/PH-20-18	IPD/PH-20-18	IPD/PH-20-18
	25	IPD/PH-20-25	IPD/PH-20-25	IPD/PH-20-25
	32	IPD/PH-20-32	IPD/PH-20-32	IPD/PH-20-32
ASC Screwdriver				
TPA	18	IPD/KA-CT-18	IPD/KA-CT-18	IPD/KA-CT-18
	25	IPD/KA-CT-25	IPD/KA-CT-25	IPD/KA-CT-25
	32	IPD/KA-CT-32	IPD/KA-CT-32	IPD/KA-CT-32
PSD Screwdriver				
PSD	25	IPD/LL-PS-00	IPD/LL-PS-00	IPD/LL-PS-00



ACCESSORIES

Indication	Length (mm)	NP ø3.5	RP ø4.1	WP ø5.1
Clinical RA Shank Handle	16	IPD/MC-00-16	IPD/MC-00-16	IPD/MC-00-16
Laboratory RA Shank Handle	70	IPD/ML-00-70	IPD/ML-00-70	IPD/ML-00-70
RA Shank Ratchet	90	IPD/DI-00-90	IPD/DI-00-90	IPD/DI-00-90
Ratchet adapter		IPD/DI-KA-90	IPD/DI-KA-90	IPD/DI-KA-90
PSD and insert extractor tool		IPD/LL-PS-01	IPD/LL-PS-01	IPD/LL-PS-01

Please see page 210 for more information.



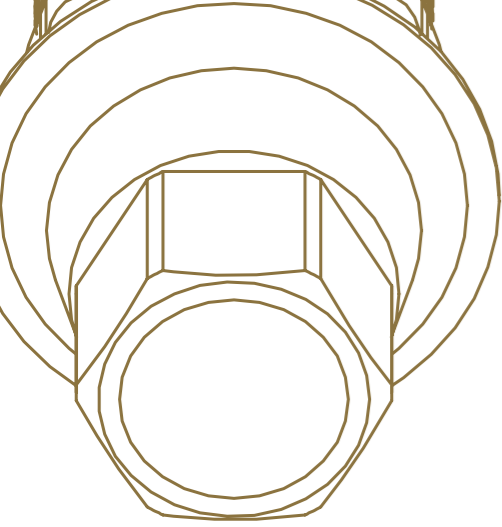

KLOCKNER®

CD VEGA®

Prosthetic Platform [NV ø3.5 /RV ø4.0-ø4.5]

SCAN BODY

	Indication	Height (mm)	NV ø3.5	RV ø4.0-ø4.5
Scan Body		10	IPD/CD-SN-00	IPD/CD-SR-00
		15	IPD/CD-SN-02	IPD/CD-SR-02
		10	IPD/CD-SN-01	IPD/CD-SR-01

Captive screw included. 1.20 Hex Screwdriver.



Ti-BASE Custom Ti-Base System®

Indication	Gingival Height (mm)	NV ø3.5	RV ø4.0-ø4.5
	0.7	IPD/CD-IN-00/3D	IPD/CD-IR-00/3D
	1.5	IPD/CD-IN-02/3D	IPD/CD-IR-02/3D
	2.5	IPD/CD-IN-04/3D	IPD/CD-IR-04/3D
	3.5	IPD/CD-IN-06/3D	IPD/CD-IR-06/3D
	Cutting guide KIT		IPD/KT-IN-00
	0.7	IPD/CD-IN-01/3D	IPD/CD-IR-01/3D
	1.5	IPD/CD-IN-03/3D	IPD/CD-IR-03/3D
	2.5	IPD/CD-IN-05/3D	IPD/CD-IR-05/3D
	3.5	IPD/CD-IN-07/3D	IPD/CD-IR-07/3D
	Cutting guide KIT		IPD/KT-IN-01

Please see page 204 for the IPD Custom Interface System accessories.



SCREWS

IPD compatible	For straight channels	Torque value	NV ø3.5	RV ø4.0-ø4.5
Screwdriver	Coating	Seat	25 Ncm	25 Ncm
Star	-	Conical	IPD/CD-TN-00	IPD/CD-TR-00
Star	TiN	Conical	IPD/CD-TN-00/TiN	IPD/CD-TR-00/TiN
Star	BLC	Conical	IPD/CD-TN-00/BLC	IPD/CD-TR-00/BLC
For ASC options		Torque value	25 Ncm	25 Ncm
Screwdriver	Coating	Seat		
TPA	TiN	Conical	IPD/CD-TN-50	IPD/CD-TR-50



[RETURN TO INDEX](#)

MULTI-UNIT ABUTMENT

Angulation	Indication	Gingival Height (mm)	NV ø3.5	RV ø4.0-ø4.5
0°		1.5	IPD/CD-MN-01	IPD/CD-MR-01
		2.5	IPD/CD-MN-02	IPD/CD-MR-02
		3.5	IPD/CD-MN-03	IPD/CD-MR-03
		4.5	IPD/CD-MN-04	IPD/CD-MR-04
		5.5	IPD/CD-MN-05	IPD/CD-MR-05
17°		2.5	IPD/CD-MN-12	IPD/CD-MR-12
30°		3.5	IPD/CD-MN-33	IPD/CD-MR-33
Replacement Screw for Angled MUA			IPD/KA-MT-05	IPD/KA-MT-11

Straight Multi-unit abutments can be used for single and multiple restorations. Please see page 206 for the Multi-unit system accessories.



MULTI-UNIT AP ABUTMENT*

*Check availability

Angulation	Indication	Gingival Height (mm)	NV ø3.5	RV ø4.0-ø4.5
17°		2.5	IPD/CD-MN-12/AP	IPD/CD-MR-12/AP
		3.5	IPD/CD-MN-13/AP	IPD/CD-MR-13/AP
30°		3.5	IPD/CD-MN-33/AP	IPD/CD-MR-33/AP
		4.5	IPD/CD-MN-34/AP	IPD/CD-MR-34/AP
Replacement Screw for Angled MUA AP			IPD/KA-MT-05/BLC	IPD/KA-MT-11/BLC

Please see page 206 for the Multi-unit system accessories.



ANALOGS

Type		NV ø3.5	RV ø4.0-ø4.5
Standard		IPD/CD-AN-00	IPD/CD-AR-00
	Full set	IPD/CD-AN-90/3D	IPD/CD-AR-90/3D
Digital	Analog		
	Bottom Screw		
	Side Screw		



Co-Cr BASE ABUTMENT

		NV ø3.5	RV ø4.0-ø4.5
Co-Cr Base for analogic workflow			
Indication	Angulation		
	0°	IPD/CD-BN-00	IPD/CD-BR-00
	15°	IPD/CD-BN-10	IPD/CD-BR-10
	25°	IPD/CD-BN-20	-
	0°	IPD/CD-BN-01	IPD/CD-BR-01
	15°	IPD/CD-BN-11	IPD/CD-BR-11
	25°	IPD/CD-BN-21	-
Co-Cr Base for digital workflow			
Indication	Angulation		
	Straight/ASC	IPD/CD-BN-00/3D	IPD/CD-BR-00/3D
	Straight/ASC	IPD/CD-BN-01/3D	IPD/CD-BR-01/3D
Scan Body		IPD/SC-AN-B1	IPD/SC-AN-B1

All ASC CoCr analogic workflow abutments include the relevant TPA screw.



PSD OVERDENTURE ABUTMENT

Indication	Gingival Height (mm)	NV ø3.5	RV ø4.0-ø4.5
	1.0	IPD/CD-LN-01	IPD/CD-LR-01
	2.0	IPD/CD-LN-02	IPD/CD-LR-02
	3.0	IPD/CD-LN-03	IPD/CD-LR-03
	4.0	IPD/CD-LN-04	IPD/CD-LR-04
	5.0	IPD/CD-LN-05	IPD/CD-LR-05
	6.0	IPD/CD-LN-06	IPD/CD-LR-06
	7.0	IPD/CD-LN-07	IPD/CD-LR-07

Please see page 205 for the PSD system accessories.



TEMPORARY ABUTMENT / OPEN TRAY COPING

Indication	Gingival Height (mm)	NV ø3.5	RV ø4.0-ø4.5
	1.5	IPD/CD-PN-06	IPD/CD-PR-06
	1.5	IPD/CD-PN-07	IPD/CD-PR-07
Long coping screw		IPD/CD-TN-00/C	IPD/CD-TR-00/C

The same abutment can be used as a temporary abutment with the occlusal screw or as an impression coping using the coping screw.



HEALING ABUTMENT

Gingival Height (mm)	Head Diameter (mm)	NV ø3.5	RV ø4.0-ø4.5
1.5	ø3.8	IPD/CD-DN-01	IPD/CD-DR-01
3.0		IPD/CD-DN-03	IPD/CD-DR-03
5.0		IPD/CD-DN-05	IPD/CD-DR-05



SCREWDRIVERS

Type	Length (mm)	NV ø3.5	RV ø4.0-ø4.5
Implant system Screwdriver			
	18	IPD/PS-00-18	IPD/PS-00-18
Star	25	IPD/PS-00-25	IPD/PS-00-25
	32	IPD/PS-00-32	IPD/PS-00-32
IPD Scan Body and extra Screwdrivers			
	18	IPD/PH-20-18	IPD/PH-20-18
1.20 Hex	25	IPD/PH-20-25	IPD/PH-20-25
	32	IPD/PH-20-32	IPD/PH-20-32
ASC Screwdriver			
	18	IPD/KA-CT-18	IPD/KA-CT-18
TPA	25	IPD/KA-CT-25	IPD/KA-CT-25
	32	IPD/KA-CT-32	IPD/KA-CT-32
PSD Screwdriver			
PSD	25	IPD/LL-PS-00	IPD/LL-PS-00



ACCESSORIES

Indication	Length (mm)	NV ø3.5	RV ø4.0-ø4.5
Clinical RA Shank Handle	16	IPD/MC-00-16	IPD/MC-00-16
Laboratory RA Shank Handle	70	IPD/ML-00-70	IPD/ML-00-70
RA Shank Ratchet	90	IPD/DI-00-90	IPD/DI-00-90
Ratchet adapter		IPD/DI-KA-90	IPD/DI-KA-90
PSD and insert extractor tool		IPD/LL-PS-01	IPD/LL-PS-01

Please see page 210 for more information.



STRAUMANN®

DA TISSUE LEVEL®

Prosthetic platform [SynOcta RN ø4.8 / RN ø4.8 / WN ø6.5]

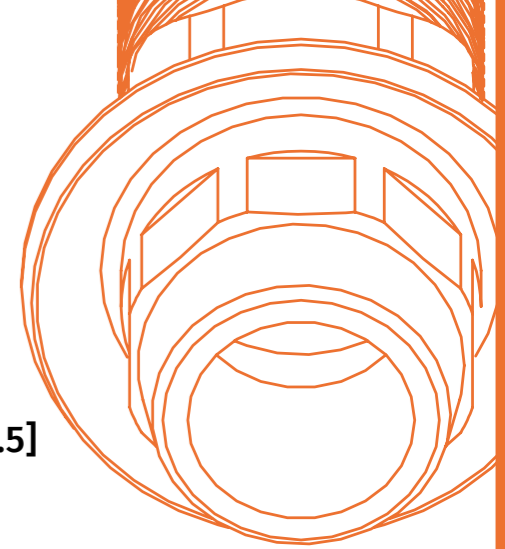

SCAN BODY

	Indication	Height (mm)	SynOcta RN ø4.8	RN ø4.8	WN ø6.5
Scan Body		10	-	IPD/DA-SR-00	IPD/DA-SW-00
		15	-	IPD/DA-SR-02	-
		10	-	IPD/DA-SR-01	IPD/DA-SW-01

Captive screw included. 1.20 Hex Screwdriver.



Ti-BASE Custom Ti-Base System®

Indication	Gingival Height (mm)	SynOcta RN ø4.8	RN ø4.8	WN ø6.5
	0.4	-	IPD/DA-IR-00/3D	IPD/DA-IW-02/3D
		Cutting guide KIT		IPD/KT-IR-00
	0.4	-	IPD/DA-IR-01/3D	IPD/DA-IW-03/3D
		Cutting guide KIT		IPD/KT-IR-01

Please see page 204 for the IPD Custom Interface System accessories.



IPDMILLED SYSTEM*

*Check availability

Indication	Material	Diameter (mm)	SynOcta RN ø4.8	RN ø4.8	WN ø6.5
TYPE IPD System (Compatible with NT/IPD Holders)					
	Ti	12	-	IPD/DA-XR-00	IPD/DA-XW-00
Mill Analog			-	IPD/DA-AR-00/X	IPD/DA-AW-00/X
TYPE A System (Compatible with DESS® Holders)					
	Ti	15	-	PR/DA-XR-15/A	PR/DA-XW-15/A

All premilled abutments include 2 titanium screws.



RETURN TO INDEX

SCREWS

			SynOcta RN ø4.8	RN ø4.8	WN ø6.5
IPD compatible	For straight channels	Torque value	35 Ncm	35 Ncm	35 Ncm
Screwdriver	Coating	Seat			
Torx	-	Conical	IPD/DA-TR-00	IPD/DA-TR-01	IPD/DA-TR-01
Torx	TiN	Conical	IPD/DA-TR-00/TiN	IPD/DA-TR-01/TiN	IPD/DA-TR-01/TiN
Torx	BLC	Conical	IPD/DA-TR-00/BLC	IPD/DA-TR-01/BLC	IPD/DA-TR-01/BLC

			25 Ncm	25 Ncm	25 Ncm
Screwdriver	Coating	Seat			
TPA	TiN	Conical	IPD/DA-TR-50	IPD/DA-TR-51	IPD/DA-TR-51

			35 Ncm	35 Ncm	35 Ncm
Screwdriver	Coating	Seat			
Torx	-	Conical	IPD/DA-TR-00	IPD/DA-TR-03	IPD/DA-TR-03
Torx	TiN	Conical	IPD/DA-TR-00/TiN	IPD/DA-TR-03/TiN	IPD/DA-TR-03/TiN
Torx	BLC	Conical	IPD/DA-TR-00/BLC	IPD/DA-TR-03/BLC	IPD/DA-TR-03/BLC

				35 Ncm	35 Ncm
Screwdriver	Coating	Seat			
Torx	-	Conical	-	IPD/DA-TR-01/X	IPD/DA-TR-01/X

MULTI-UNIT ABUTMENT

Angulation	Gingival Height (mm)	SynOcta RN ø4.8	RN ø4.8	WN ø6.5
0°	1.0	-	IPD/DA-MR-01	-

Straight Multi-unit abutments can be used for single and multiple restorations. Please see page 206 for the Multi-unit system accessories.

ANALOGS

Type	SynOcta RN ø4.8	RN ø4.8	WN ø6.5
Standard	IPD/DA-AR-01	IPD/DA-AR-00	IPD/DA-AW-00
	Full set	IPD/DA-AR-90/3D	IPD/DA-AW-90/3D
Digital	Analog		
	Bottom Screw		
	Side Screw		

Co-Cr BASE ABUTMENT

		SynOcta RN ø4.8	RN ø4.8	WN ø6.5
Co-Cr Base for analogic workflow				
Indication	Angulation			
	0°	IPD/DA-BR-03	IPD/DA-BR-00	IPD/DA-BW-00
	15°	IPD/DA-BR-13	IPD/DA-BR-10	IPD/DA-BW-10
	25°	-	IPD/DA-BR-20	IPD/DA-BW-20
	0°	IPD/DA-BR-02	IPD/DA-BR-01	IPD/DA-BW-01
	15°	IPD/DA-BR-12	IPD/DA-BR-11	IPD/DA-BW-11
	25°	-	IPD/DA-BR-21	IPD/DA-BW-21
Co-Cr Base for digital workflow				
Indication	Angulation			
	Straight/ASC	IPD/DA-BR-03/3D	IPD/DA-BR-00/3D	IPD/DA-BW-00/3D
	Straight/ASC	IPD/DA-BR-02/3D	IPD/DA-BR-01/3D	IPD/DA-BW-01/3D
	Scan Body	IPD/SC-AN-B2	IPD/SC-AN-B2	IPD/SC-AN-B2

All ASC CoCr analogic workflow abutments include the relevant TPA screw.



CASTABLE ABUTMENT

Indication	SynOcta RN ø4.8	RN ø4.8	WN ø6.5
	IPD/DA-HR-00	IPD/DA-HR-01	-
	IPD/DA-RR-00	IPD/DA-RR-01	-



PSD OVERDENTURE ABUTMENT

Indication	Gingival Height (mm)	SynOcta RN ø4.8	RN ø4.8	WN ø6.5
	1.0	-	IPD/DA-LR-01	-
	2.0	-	IPD/DA-LR-02	-
	3.0	-	IPD/DA-LR-03	-

Please see page 205 for the PSD system accessories.



TEMPORARY ABUTMENT / OPEN TRAY COPING

Indication	Gingival Height (mm)	SynOcta RN ø4.8	RN ø4.8	WN ø6.5
	1.5	IPD/DA-PR-09	IPD/DA-PR-06	IPD/DA-PW-06
	1.5	IPD/DA-PR-08	IPD/DA-PR-07	IPD/DA-PW-07
	Long coping screw	IPD/DA-TR-00/C	IPD/DA-TR-01/C	IPD/DA-TR-01/C

The same abutment can be used as a temporary abutment with the occlusal screw or as an impression coping using the coping screw.



HEALING ABUTMENT

Gingival Height (mm)	SynOcta RN ø4.8	RN ø4.8	WN ø6.5
	Head Diameter (mm)		ø5.5
Sealing cap	-	IPD/DA-DR-00	-
1.5	-	IPD/DA-DR-01	-
3.0	-	IPD/DA-DR-03	-
4.5	-	IPD/DA-DR-04	-



TI CEMENT-RETAINED ABUTMENT

Indication	Angulation	Gingival Height	SynOcta RN ø4.8	RN ø4.8	WN ø6.5
	0°	2.0	-	IPD/DA-PR-01	IPD/DA-PW-00



SYNOCTA ABUTMENT

Indication	Angulation	SynOcta RN ø4.8	RN ø4.8	WN ø6.5
	0°	-	IPD/DA-PR-00	-



SCREWDRIVERS

Type	Length (mm)	SynOcta RN ø4.8	RN ø4.8	WN ø6.5
Implant system Screwdriver				
Torx	18	IPD/PT-00-18	IPD/PT-00-18	IPD/PT-00-18
	25	IPD/PT-00-25	IPD/PT-00-25	IPD/PT-00-25
	32	IPD/PT-00-32	IPD/PT-00-32	IPD/PT-00-32
IPD Scan Body and extra Screwdrivers				
1.20 Hex	18	IPD/PH-20-18	IPD/PH-20-18	IPD/PH-20-18
	25	IPD/PH-20-25	IPD/PH-20-25	IPD/PH-20-25
	32	IPD/PH-20-32	IPD/PH-20-32	IPD/PH-20-32
ASC Screwdriver				
TPA	18	IPD/KA-CT-18	IPD/KA-CT-18	IPD/KA-CT-18
	25	IPD/KA-CT-25	IPD/KA-CT-25	IPD/KA-CT-25
	32	IPD/KA-CT-32	IPD/KA-CT-32	IPD/KA-CT-32
PSD Screwdriver				
PSD	25	IPD/LL-PS-00	IPD/LL-PS-00	IPD/LL-PS-00



ACCESSORIES

Indication	Length (mm)	SynOcta RN ø4.8	RN ø4.8	WN ø6.5
Clinical RA Shank Handle	16	IPD/MC-00-16	IPD/MC-00-16	IPD/MC-00-16
Laboratory RA Shank Handle	70	IPD/ML-00-70	IPD/ML-00-70	IPD/ML-00-70
RA Shank Ratchet	90	IPD/DI-00-90	IPD/DI-00-90	IPD/DI-00-90
Ratchet adapter		IPD/DI-KA-90	IPD/DI-KA-90	IPD/DI-KA-90
PSD and insert extractor tool		IPD/LL-PS-01	IPD/LL-PS-01	IPD/LL-PS-01

Please see page 210 for more information.



STRAUMANN®

DB BONE LEVEL®

Prosthetic platform [NC ø3.3 / RC ø4.1]

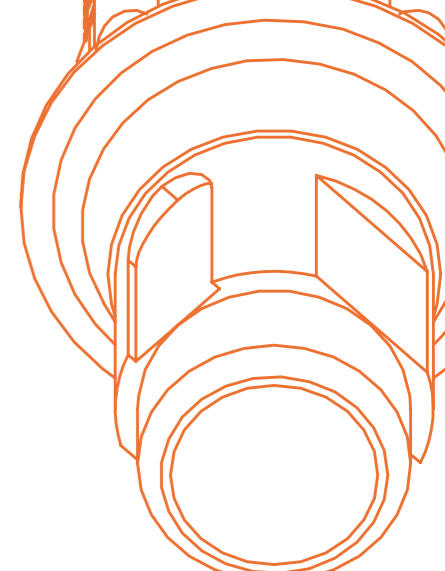

SCAN BODY

	Indication	Height (mm)	NC ø3.3	RC ø4.1
Scan Body		10	IPD/DB-SN-00	IPD/DB-SR-00
		15	IPD/DB-SN-02	IPD/DB-SR-02
		10	IPD/DB-SN-01	IPD/DB-SR-01

Captive screw included. 1.20 Hex Screwdriver.



Ti-BASE Custom Ti-Base System®

Indication	Gingival Height (mm)	NC ø3.3	RC ø4.1
	0.5	IPD/DB-IN-00/3D	IPD/DB-IR-00/3D
	1.5	IPD/DB-IN-02/3D	IPD/DB-IR-02/3D
	2.5	IPD/DB-IN-04/3D	IPD/DB-IR-04/3D
	3.5	IPD/DB-IN-06/3D	IPD/DB-IR-06/3D
Cutting guide KIT		IPD/KT-IN-00	IPD/KT-IR-00
	0.5	IPD/DB-IN-01/3D	IPD/DB-IR-01/3D
	1.5	IPD/DB-IN-03/3D	IPD/DB-IR-03/3D
	2.5	IPD/DB-IN-05/3D	IPD/DB-IR-05/3D
	3.5	IPD/DB-IN-07/3D	IPD/DB-IR-07/3D
Cutting guide KIT		IPD/KT-IN-01	IPD/KT-IR-01

Please see page 204 for the IPD Custom Interface System accessories.



IPDMILLED SYSTEM*

*Check availability

Indication	Material	Diameter (mm)	NC ø3.3	RC ø4.1
TYPE IPD System (Compatible with NT/IPD Holders)				
	Ti	12	IPD/DB-XN-00	IPD/DB-XR-00
Mill Analog			IPD/DB-AN-00/X	IPD/DB-AR-00/X
TYPE A System (Compatible with DESS® Holders)				
	Ti	10	-	PR/DB-XR-10/A
	Ti	15	PR/DB-XN-15/A	PR/DB-XR-15/A

All premilled abutments include 2 titanium screws.



RETURN TO INDEX

SCREWS

			NC Ø3.3	RC Ø4.1
IPD and OEM compatible	For straight channels	Torque value	35 Ncm	35 Ncm
Screwdriver	Coating	Seat		
Torx	-	Conical	IPD/DB-TR-00	IPD/DB-TR-00
Torx	TiN	Conical	IPD/DB-TR-00/TiN	IPD/DB-TR-00/TiN
Torx	BLC	Conical	IPD/DB-TR-00/BLC	IPD/DB-TR-00/BLC
		For ASC options	20 Ncm	20 Ncm
Screwdriver	Coating	Seat		
TPA	TiN	Conical	IPD/DB-TR-50	IPD/DB-TR-50



MULTI-UNIT ABUTMENT

Angulation	Indication	Gingival	IPD/KA-MT-04	NC Ø3.3	RC Ø4.1
0°		1.5	IPD/DB-MN-01	IPD/DB-MR-01	
		2.5	IPD/DB-MN-02	IPD/DB-MR-02	
		3.5	IPD/DB-MN-03	IPD/DB-MR-03	
		4.5	IPD/DB-MN-04	IPD/DB-MR-04	
17°		2.5	IPD/DB-MN-12	IPD/DB-MR-12 ¹	
		3.5	IPD/DB-MN-13	IPD/DB-MR-13 ²	
30°		3.5	IPD/DB-MN-33	IPD/DB-MR-33 ³	
		4.5	IPD/DB-MN-34	IPD/DB-MR-34 ⁴	
			IPD/KA-MT-04	IPD/KA-MT-05 ⁵	
Replacement Screw for Angled MUA			IPD/KA-MT-02 ²		



Straight Multi-unit abutments can be used for single and multiple restorations. Please see page 206 for the Multi-unit system accessories.

MULTI-UNIT AP ABUTMENT* ^{NEW}

*Check availability

Angulation	Indication	Gingival Height (mm)	NC Ø3.3	RC Ø4.1
17°		2.5	IPD/DB-MN-12/AP	IPD/DB-MR-12/AP
		3.5	IPD/DB-MN-13/AP	IPD/DB-MR-13/AP
30°		3.5	IPD/DB-MN-33/AP	IPD/DB-MR-33/AP
		4.5	IPD/DB-MN-34/AP	IPD/DB-MR-34/AP
Replacement Screw for Angled MUA AP			IPD/KA-MT-04/BLC	IPD/KA-MT-02/BLC

Please see page 206 for the Multi-unit system accessories.



ANALOGS

Type		NC Ø3.3	RC Ø4.1
Standard		IPD/DB-AN-00	IPD/DB-AR-00
	Full set	IPD/DB-AN-90/3D	IPD/DB-AR-90/3D
Digital	Analog		
	Bottom Screw		
	Side Screw		



Co-Cr BASE ABUTMENT

		NC Ø3.3	RC Ø4.1
Co-Cr Base for analogic workflow			
Indication	Angulation		
	0°	IPD/DB-BN-00	IPD/DB-BR-00
	15°	IPD/DB-BN-10	IPD/DB-BR-10
	0°	IPD/DB-BN-01	IPD/DB-BR-01
	15°	IPD/DB-BN-11	IPD/DB-BR-11
Co-Cr Base for digital workflow			
Indication	Angulation		
	Straight/ASC	IPD/DB-BN-00/3D	IPD/DB-BR-00/3D
	Straight/ASC	IPD/AA-BN-01/3D	IPD/DB-BR-01/3D
Scan Body		IPD/SC-AN-B1	IPD/SC-AN-B1

All ASC CoCr analogic workflow abutments include the relevant TPA screw.



CASTABLE ABUTMENT

Indication	NC Ø3.3	RC Ø4.1
	-	IPD/DB-HR-00
	-	IPD/DB-RR-00

All ASC CrCo analogic workflow abutments include the relevant TPA screw.



PSD OVERDENTURE ABUTMENT

Indication	Gingival Height (mm)	NC Ø3.3	RC Ø4.1
	1.0	IPD/DB-LN-01	IPD/DB-LR-01
	2.0	IPD/DB-LN-02	IPD/DB-LR-02
	3.0	IPD/DB-LN-03	IPD/DB-LR-03
	4.0	IPD/DB-LN-04	IPD/DB-LR-04
	5.0	IPD/DB-LN-05	IPD/DB-LR-05

Please see page 205 for the PSD system accessories.



TEMPORARY ABUTMENT / OPEN TRAY COPING

Indication	Gingival Height (mm)	NC Ø3.3	RC Ø4.1
	1.5	IPD/DB-PN-06	IPD/DB-PR-06
	1.5	IPD/DB-PN-07	IPD/DB-PR-07
	Long coping screw	IPD/DB-TR-00/C	IPD/DB-TR-00/C

The same abutment can be used as a temporary abutment with the occlusal screw or as an impression coping using the coping screw.



HEALING ABUTMENT

Gingival Height (mm)	Head Diameter (mm)	NC Ø3.3	RC Ø4.1
		Ø3.8	Ø4.5
2.0		IPD/DB-DN-02	IPD/DB-DR-02
3.5		IPD/DB-DN-03	-
4.0		-	IPD/DB-DR-04
5.0		IPD/DB-DN-05	-
6.0		-	IPD/DB-DR-06



TI CEMENT-RETAINED ABUTMENT

Indication	Angulation	Gingival Height	NC ø3.3	RC ø4.1
	0°	2.0	-	IPD/DB-PR-00



SCREWDRIVERS

Type	Length (mm)	NC ø3.3	RC ø4.1
Implant system Screwdriver			
Torx	18	IPD/PT-00-18	IPD/PT-00-18
	25	IPD/PT-00-25	IPD/PT-00-25
	32	IPD/PT-00-32	IPD/PT-00-32
IPD Scan Body and extra Screwdrivers			
1.20 Hex	18	IPD/PH-20-18	IPD/PH-20-18
	25	IPD/PH-20-25	IPD/PH-20-25
	32	IPD/PH-20-32	IPD/PH-20-32
ASC Screwdriver			
TPA	18	IPD/KA-CT-18	IPD/KA-CT-18
	25	IPD/KA-CT-25	IPD/KA-CT-25
	32	IPD/KA-CT-32	IPD/KA-CT-32
PSD Screwdriver			
PSD	25	IPD/LL-PS-00	IPD/LL-PS-00



ACCESSORIES

Indication	Length (mm)	NC ø3.3	RC ø4.1
Clinical RA Shank Handle	16	IPD/MC-00-16	IPD/MC-00-16
Laboratory RA Shank Handle	70	IPD/ML-00-70	IPD/ML-00-70
RA Shank Ratchet	90	IPD/DI-00-90	IPD/DI-00-90
Ratchet adapter		IPD/DI-KA-90	IPD/DI-KA-90
PSD and insert extractor tool		IPD/LL-PS-01	IPD/LL-PS-01



Please see page 210 for more information.

STRAUMANN®

DC BLX® Prosthetic platform [RB/WB]

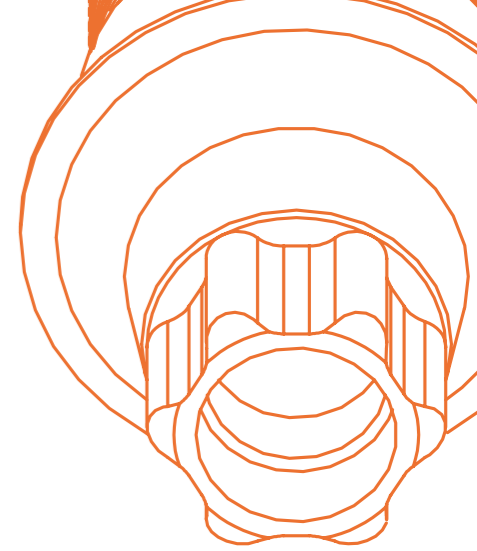

SCAN BODY

Indication	Height (mm)	RB/WB
	10	IPD/DC-SR-00
	15	IPD/DC-SR-02
	10	IPD/DC-SR-01

Captive screw included. 1.20 Hex Screwdriver.



Ti-BASE Custom Ti-Base System®

Indication	Gingival Height (mm)	RB/WB
	1.0	IPD/DC-IR-00/3D
	2.0	IPD/DC-IR-02/3D
	3.0	IPD/DC-IR-04/3D
Cutting guide KIT		IPD/KT-IR-00
	1.0	IPD/DC-IR-01/3D
	2.0	IPD/DC-IR-03/3D
	3.0	IPD/DC-IR-05/3D
Cutting guide KIT		IPD/KT-IR-01



Please see page 204 for the IPD Custom Interface System accessories.

IPDMILLED SYSTEM*

*Check availability

Indication	Material	Diameter (mm)	RB/WB
TYPE IPD System (Compatible with NT/IPD Holders)			
	Ti	12	IPD/DC-XR-00
Mill Analog			IPD/DC-AR-00/X
TYPE A System (Compatible with DESS® Holders)			
	Ti	15	PR/DC-XR-15/A

All premilled abutments include 2 titanium screws.







SCREWS

Indication	Material	Torque value	RB/WB
IPD and OEM compatible	For straight channels		30 Ncm
Screwdriver	Coating	Seat	
Torx	-	Conical	IPD/DC-TR-00
Torx	TiN	Conical	IPD/DC-TR-00/TIN
Torx	BLC	Conical	IPD/DC-TR-00/BLC
Removing tool			IPD/DC-TR-01

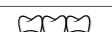

[RETURN TO INDEX](#)

MULTI-UNIT ABUTMENT





Angulation	Indication	Gingival Height (mm)	RB/WB ●
0°		1.5	IPD/DC-MR-01
		2.5	IPD/DC-MR-02
		3.5	IPD/DC-MR-03
17°		3.5	IPD/DC-MR-13
30°		4.5	IPD/DC-MR-34
Replacement Screw for Angled MUA			IPD/KA-MT-05

Straight Multi-unit abutments can be used for single and multiple restorations. Please see page 206 for the Multi-unit system accessories.



MULTI-UNIT AP ABUTMENT*^{NEW}

*Check availability

Angulation	Indication	Gingival Height (mm)	RB/WB ●
17°		2.5	IPD/DC-MR-12/AP
		3.5	IPD/DC-MR-13/AP
30°		3.5	IPD/DC-MR-33/AP
		4.5	IPD/DC-MR-34/AP
Replacement Screw for Angled MUA AP			IPD/KA-MT-05/BLC

Please see page 206 for the Multi-unit system accessories.







ANALOGS

Type	RB/WB ●	
Standard	IPD/DC-AR-00	
Digital	Full set	IPD/DC-AR-90/3D
	Analog	
	Bottom Screw	
	Side Screw	



Co-Cr BASE ABUTMENT

Indication	Angulation	RB/WB ●
Co-Cr Base for analogic workflow		
	0°	IPD/DC-BR-00
	0°	IPD/DC-BR-01
Co-Cr Base for digital workflow		
	Straight	IPD/DC-BR-00/3D
	Straight	IPD/DC-BR-01/3D
	Scan Body	IPD/SC-AN-B1





PSD OVERDENTURE ABUTMENT

Indication	Gingival Height (mm)	RB/WB ●
	2.0	IPD/DC-LR-02
	3.0	IPD/DC-LR-03
	4.0	IPD/DC-LR-04
	5.0	IPD/DC-LR-05

Please see page 205 for the PSD system accessories.



TEMPORARY ABUTMENT / OPEN TRAY COPING

Indication	Gingival Height (mm)	RB/WB ●
	1.5	IPD/DC-PR-06
	1.5	IPD/DC-PR-07
Long coping screw		IPD/DC-TR-00/C

The same abutment can be used as a temporary abutment with the occlusal screw or as an impression coping using the coping screw.



HEALING ABUTMENT

Gingival Height (mm)	Head Diameter (mm)	RB/WB ●
	ø4.5	
1.5		IPD/DC-DR-01
3.0		IPD/DC-DR-03
5.0		IPD/DC-DR-05



SCREWDRIVERS

Type	Length (mm)	RB/WB ●
Implant system Screwdriver		
Torx	18	IPD/PT-00-18
	25	IPD/PT-00-25
	32	IPD/PT-00-32
IPD Scan Body and extra Screwdriver		
1.20 Hex	18	IPD/PH-20-18
	25	IPD/PH-20-25
	32	IPD/PH-20-32
PSD Screwdriver		
PSD	25	IPD/LL-PS-00



ACCESSORIES

Indication	Length (mm)	RB/WB ●
Clinical RA Shank Handle	16	IPD/MC-00-16
Laboratory RA Shank Handle	70	IPD/ML-00-70
RA Shank Ratchet	90	IPD/DI-00-90
Ratchet adapter		IPD/DI-KA-90
PSD and insert extractor tool		IPD/LL-PS-01

Please see page 210 for more information.



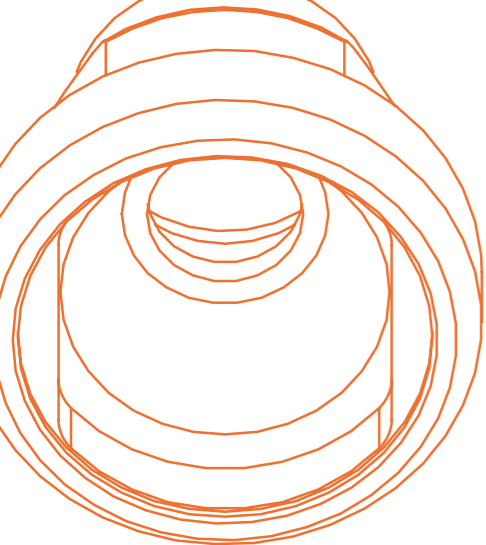

STRAUMANN®

DD SRA®

Prosthetic platform [Ø3.5 / Ø4.6]

SCAN BODY/ SCAN DATA MARKER* NEW

*Check availability

	Indication	Height (mm)	Ø3.5	Ø4.6
Scan Body		8.0	IPD/DD-SN-01	IPD/DD-SR-01
One Shot IQ		6	IPD/DD-SN-03	IPD/DD-SR-03
Reverse IQ			IPD/DD-SN-00/RS	IPD/DD-SR-00/RS

Captive screw included except on Reverse Marker IQ. 1.20 Hex Screwdriver.



SCANLOGIQ® FULL ARCH SYSTEM* NEW

*Check availability

		Ø3.5	Ø4.6
ScanLogIQ® KIT	ScanLogIQ® Box	IPD/DD-KN-00/FS	IPD/DD-KR-00/FS
	1 Scan Flag IQ Set 6 One Shot IQ 6 Reverse IQ 1 Control Plate IQ 1 Screwdriver 1 Clinical Handle		
Scan Flag IQ SET	3 Short 3 Medium 4 Large 0° 2 Large +20° 2 Large -20°	IPD/DD-KN-01/FS	IPD/DD-KR-01/FS
Control Plate IQ		IPD/KT-FS-00	IPD/KT-FS-00

Captive screw IPD/AB-TR-00/FS included on all Scan Flag IQ. 1.25 Hex Screwdriver.



Ti-BASE Custom Ti-Base System®

Indication	Post height (mm)	Gingival Height (mm)	Ø3.5	Ø4.6
	4.3	0.2	IPD/DD-IN-01/3D	IPD/DD-IR-01/3D



SCREWS

			Ø3.5	Ø4.6
IPD and OEM compatible	For straight channels	Torque value	15 Ncm	15 Ncm
Screwdriver	Coating	Seat		
Torx	-	Conical	IPD/DD-TR-00	IPD/DD-TR-00
Torx	TiN	Conical	IPD/DD-TR-00/TiN	IPD/DD-TR-00/TiN
Torx	BLC	Conical	IPD/DD-TR-00/BLC	IPD/DD-TR-00/BLC
		For ASC options	15 Ncm	15 Ncm
Screwdriver	Coating	Seat		
TPA	TiN	Conical	IPD/DD-TR-50	IPD/DD-TR-50



ANALOGS

Type		Ø3.5	Ø4.6
Standard		IPD/DD-AN-00	IPD/DD-AR-00
	Full set	IPD/DD-AN-90/3D	IPD/DD-AR-90/3D
Digital		Analog	
		Bottom Screw	
		Side Screw	



TEMPORARY ABUTMENT / OPEN TRAY COPING

Indication	Gingival Height (mm)	Ø3.5	Ø4.6
	1.5	IPD/DD-PN-06	IPD/DD-PR-06
	1.5	IPD/DD-PN-07	IPD/DD-PR-07
		Long coping screw	IPD/DD-TR-00/C

The same abutment can be used as a temporary abutment with the occlusal screw or as an impression coping using the coping screw.



HEALING ABUTMENT

Gingival Height (mm)		Ø3.5	Ø4.6
4.5	Head Diameter (mm)	Ø4.1	Ø5.1
	Screw	IPD/DD-DN-04	IPD/DD-DR-04
		IPD/DD-TR-00	IPD/DD-TR-00

Screw not included



SCREWDRIVERS

Type	Length (mm)	Ø3.5	Ø4.6
Implant system Screwdriver			
Torx	18	IPD/PT-00-18	IPD/PT-00-18
	25	IPD/PT-00-25	IPD/PT-00-25
	32	IPD/PT-00-32	IPD/PT-00-32
IPD Scan Body and extra Screwdrivers			
1.20 Hex	18	IPD/PH-20-18	IPD/PH-20-18
	25	IPD/PH-20-25	IPD/PH-20-25
	32	IPD/PH-20-32	IPD/PH-20-32
ASC Screwdriver			
TPA	18	IPD/KA-CT-18	IPD/KA-CT-18
	25	IPD/KA-CT-25	IPD/KA-CT-25
	32	IPD/KA-CT-32	IPD/KA-CT-32



[RETURN TO INDEX](#)

ACCESSORIES

Indication	Length (mm)	Ø3.5	Ø4.6
Clinical RA Shank Handle	16	IPD/MC-00-16	IPD/MC-00-16
Laboratory RA Shank Handle	70	IPD/ML-00-70	IPD/ML-00-70
RA Shank Ratchet	90	IPD/DI-00-90	IPD/DI-00-90
Ratchet adapter		IPD/DI-KA-90	IPD/DI-KA-90

Please see page 210 for more information.



STRAUMANN®

DE TLX®

Prosthetic platform [NT / RT / WT]

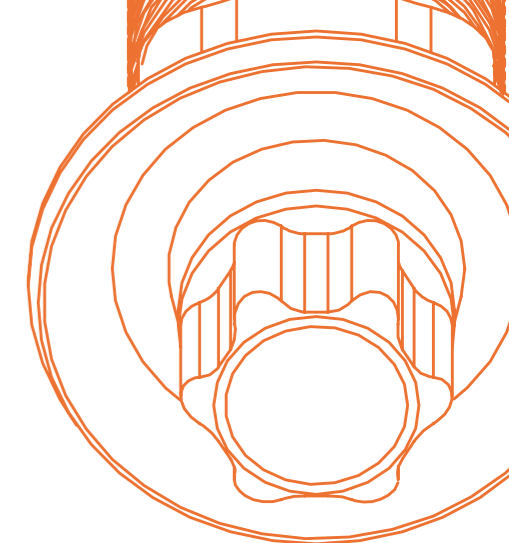

SCAN BODY

	Indication	Height (mm)	NT	RT	WT
Scan Body		10	IPD/DE-SN-00	IPD/DE-SR-00	IPD/DE-SW-00
		15	IPD/DE-SN-02	IPD/DE-SR-02	-
		10	IPD/DE-SN-01	IPD/DE-SR-01	IPD/DE-SW-01

Captive screw included. 1.20 Hex Screwdriver.



Ti-BASE Custom Ti-Base System®

Indication	Gingival Height (mm)	NT	RT	WT
	0.4	IPD/DE-IN-00/3D	IPD/DE-IR-00/3D	IPD/DE-IW-00/3D
	Cutting guide KIT	IPD/KT-IN-00	IPD/KT-IR-00	IPD/KT-IW-00
	0.4	IPD/DE-IN-01/3D	IPD/DE-IR-01/3D	IPD/DE-IW-01/3D
	Cutting guide KIT	IPD/KT-IN-01	IPD/KT-IR-01	IPD/KT-IW-01

Please see page 204 for the IPD Custom Interface System accessories.



IPDMILLED SYSTEM*

*Check availability

Indication	Material	Diameter (mm)	NT	RT	WT
IPD Blank System (Compatible with NT/IPD Holders)					
	Ti	12	IPD/DE-XN-00	IPD/DE-XR-00	IPD/DE-XW-00
Mill Analog			IPD/DE-AN-00/X	IPD/DE-AR-00/X	IPD/DE-AW-00/X
TYPE A System (Compatible with DESS® Holders)					
	Ti	15	PR/DE-XN-15/A	PR/DE-XR-15/A	PR/DE-XW-15/A

All premilled abutments include 2 titanium screws.



SCREWS

			NT	RT	WT
IPD and OEM compatible	For straight channels	Torque value	30 Ncm	30 Ncm	30 Ncm
Screwdriver	Coating	Seat			
Torx	-	Conical	IPD/DE-TR-00	IPD/DE-TR-00	IPD/DE-TR-00
Torx	TiN	Conical	IPD/DE-TR-00/TIN	IPD/DE-TR-00/TIN	IPD/DE-TR-00/TIN
Torx	BLC	Conical	IPD/DE-TR-00/BLC	IPD/DE-TR-00/BLC	IPD/DE-TR-00/BLC
	For ASC options	Torque value	20 Ncm	20 Ncm	20 Ncm
Screwdriver	Coating	Seat			
TPA	TiN	Conical	IPD/DE-TR-50	IPD/DE-TR-50	IPD/DE-TR-50



[RETURN TO INDEX](#)

MULTI-UNIT ABUTMENT

Angulation	Indication	Gingival Height (mm)	NT	RT	WT
0°		0.9	IPD/DE-MN-01	IPD/DE-MR-01	-

Straight Multi-unit abutments can be used for single and multiple restorations. Please see page 206 for the Multi-unit system accessories.

MULTI-UNIT AP ABUTMENT* NEW

*Check availability

Angulation	Indication	Gingival Height (mm)	NT	RT	WT
17°		2.5	IPD/DE-MN-12/AP	-	-
		3.5	IPD/DE-MN-13/AP	-	-
		3.5	IPD/DE-MN-33/AP	-	-
30°		4.5	IPD/DE-MN-34/AP	-	-
		Replacement Screw for Angled MUA AP		IPD/KA-MT-05/BLC	-

Please see page 206 for the Multi-unit system accessories.

ANALOGS

Type		NT	RT	WT
Standard		IPD/DE-AN-00	IPD/DE-AR-00	IPD/DE-AW-00
	Full set	IPD/DE-AN-90/3D	IPD/DE-AR-90/3D	IPD/DE-AW-90/3D
Digital	Analog			
	Bottom Screw			
	Side Screw			

PSD OVERDENTURE ABUTMENT

Indication	Gingival Height (mm)	NT	RT	WT
	1.0	IPD/DE-LN-01	IPD/DE-LR-01	IPD/DE-LW-01
	2.0	IPD/DE-LN-02	IPD/DE-LR-02	IPD/DE-LW-02
	3.0	IPD/DE-LN-03	IPD/DE-LR-03	IPD/DE-LW-03

Please see page 205 for the PSD system accessories.

TEMPORARY ABUTMENT / OPEN TRAY COPING

Indication	Gingival Height (mm)	NT	RT	WT
	0.4	IPD/DE-PN-06	IPD/DE-PR-06	IPD/DE-PW-06
	0.4	IPD/DE-PN-07	IPD/DE-PR-07	IPD/DE-PW-07
Long coping screw		IPD/DE-TN-00/C	IPD/DE-TR-00/C	IPD/DE-TW-00/C

The same abutment can be used as a temporary abutment with the occlusal screw or as an impression coping using the coping screw.

HEALING ABUTMENT

Gingival Height (mm)	Head Diameter (mm)	NT	RT	WT
	Ø4.0		Ø5.5	Ø7.0
1.5		IPD/DE-DN-01	IPD/DE-DR-01	IPD/DE-DW-01
3.0		IPD/DE-DN-03	IPD/DE-DR-03	IPD/DE-DW-03
4.5		IPD/DE-DN-04	IPD/DE-DR-04	IPD/DE-DW-04



SCREWDRIVERS

Type	Length (mm)	NT	RT	WT
Implant system Screwdriver				
Torx	18	IPD/PT-00-18	IPD/PT-00-18	IPD/PT-00-18
	25	IPD/PT-00-25	IPD/PT-00-25	IPD/PT-00-25
	32	IPD/PT-00-32	IPD/PT-00-32	IPD/PT-00-32
IPD Scan Body and extra Screwdrivers				
1.20 Hex	18	IPD/PH-20-18	IPD/PH-20-18	IPD/PH-20-18
	25	IPD/PH-20-25	IPD/PH-20-25	IPD/PH-20-25
	32	IPD/PH-20-32	IPD/PH-20-32	IPD/PH-20-32
ASC Screwdriver				
TPA	18	IPD/KA-CT-18	IPD/KA-CT-18	IPD/KA-CT-18
	25	IPD/KA-CT-25	IPD/KA-CT-25	IPD/KA-CT-25
	32	IPD/KA-CT-32	IPD/KA-CT-32	IPD/KA-CT-32
PSD Screwdriver				
PSD	25	IPD/LL-PS-00	IPD/LL-PS-00	IPD/LL-PS-00



ACCESSORIES

Indication	Length (mm)	NT	RT	WT
Clinical RA Shank Handle	16	IPD/MC-00-16	IPD/MC-00-16	IPD/MC-00-16
Laboratory RA Shank Handle	70	IPD/ML-00-70	IPD/ML-00-70	IPD/ML-00-70
RA Shank Ratchet	90	IPD/DI-00-90	IPD/DI-00-90	IPD/DI-00-90
Ratchet adapter		IPD/DI-KA-90	IPD/DI-KA-90	IPD/DI-KA-90
PSD and insert extractor tool		IPD/LL-PS-01	IPD/LL-PS-01	IPD/LL-PS-01

Please see page 210 for more information.



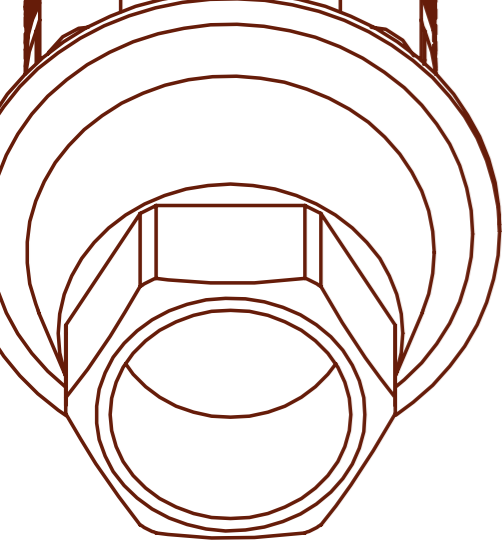

ASTRA®

EA OSSEOSPEED™

Prosthetic platform [Uniabutment 20°/40° / Yellow ø3.0
Aqua ø3.5-4.0 / Lilac ø4.5-5.0]

SCAN BODY

Indication	Height (mm)	Uniabutment 20°/40°	Yellow ø3.0	Aqua ø3.5-4.0	Lilac ø4.5-5.0
Scan Body	10	-	IPD/EA-SN-00	IPD/EA-SR-00	IPD/EA-SW-00
	15	-	IPD/EA-SN-02	IPD/EA-SR-02	IPD/EA-SW-02
	10	-	IPD/EA-SN-01	IPD/EA-SR-01	IPD/EA-SW-01

Captive screw included. 1.20 Hex Screwdriver.



Ti-BASE Custom Ti-Base System®

Indication	Gingival Height (mm)	Uniabutment 20°/40°	Yellow ø3.0	Aqua ø3.5-4.0	Lilac ø4.5-5.0
Single	0.5	-	-	IPD/EA-IR-00/3D	IPD/EA-IW-00/3D
	0.8	-	IPD/EA-IN-00/3D	-	-
	1.5	-	IPD/EA-IN-02/3D	IPD/EA-IR-02/3D	IPD/EA-IW-02/3D
	2.5	-	IPD/EA-IN-04/3D	IPD/EA-IR-04/3D	IPD/EA-IW-04/3D
	3.5	-	-	IPD/EA-IR-06/3D	-
	Cutting guide KIT			IPD/KT-IN-00	IPD/KT-IR-00
Multi-unit	0.5	-	-	IPD/EA-IR-01/3D	IPD/EA-IW-01/3D
	0.8	-	IPD/EA-IN-01/3D	-	-
	1.5	-	IPD/EA-IN-03/3D	IPD/EA-IR-03/3D	IPD/EA-IW-03/3D
	2.5	-	IPD/EA-IN-05/3D	IPD/EA-IR-05/3D	IPD/EA-IW-05/3D
	3.5	-	-	IPD/EA-IR-07/3D	-
	Cutting guide KIT			IPD/KT-IN-01	IPD/KT-IR-01

Please see page 204 for the IPD Custom Interface System accessories.



CEREC® TI-BASE SYSTEM

Indication	Gingival Height (mm)	Uniabutment 20°/40°	Yellow ø3.0	Aqua ø3.5-4.0	Lilac ø4.5-5.0
Cerec	0.5	-	-	IPD/EA-IR-00/SI	-
	1.5	-	-	IPD/EA-IR-02/SI	-
	2.5	-	-	IPD/EA-IR-04/SI	-
Cerec Block (S/L)		S			
Cerec Library Code		FX 3.8			

TiN screw included.



RETURN TO INDEX

IPDMILLED SYSTEM*

*Check availability

Indication	Material	Diameter (mm)	Uniabutment 20°/40°	Yellow ø3.0	Aqua ø3.5-4.0	Lilac ø4.5-5.0
IPD Blank System (Compatible with NT/IPD Holders)						
	Ti	12	-	-	IPD/EA-XR-00	IPD/EA-XW-00
Mill Analog			-	-	IPD/EA-AR-00/X	IPD/EA-AW-00/X
TYPE A System (Compatible with DESS® Holders)						
	Ti	15	-	-	PR/EA-XR-15/A	PR/EA-XW-15/A

All premilled abutments include 2 titanium screws.



SCREWS

			Uniabutment 20°/40°	Yellow ø3.0	Aqua ø3.5-4.0	Lilac ø4.5-5.0
IPD and OEM compatible For straight channels		Torque value	15 Ncm	15 Ncm	20 Ncm	25 Ncm
Screwdriver	Coating	Seat				
1.27 Hex	-	Flat	IPD/EA-TR-01	-	IPD/EA-TR-00	IPD/EA-TW-00
1.27 Hex	TiN	Flat	IPD/EA-TR-01/TiN	-	IPD/EA-TR-00/TiN	IPD/EA-TW-00/TiN
1.27 Hex	BLC	Flat	IPD/EA-TR-01/BLC	-	IPD/EA-TR-00/BLC	IPD/EA-TW-00/BLC
1.27 Hex	-	Conical	-	IPD/EA-TN-00	-	-
1.27 Hex	TiN	Conical	-	IPD/EA-TN-00/TiN	-	-
1.27 Hex	BLC	Conical	-	IPD/EA-TN-00/BLC	-	-
		Torque value	15 Ncm	15 Ncm	20 Ncm	25 Ncm
		Screwdriver				
TPA	TiN	Flat	IPD/EA-TR-51	-	IPD/EA-TR-50	IPD/EA-TR-50
TPA	TiN	Conical	-	IPD/EA-TN-50	-	-
		Torque value		15 Ncm	20 Ncm	25 Ncm
		Screwdriver				
TPA	TiN	Flat	-	-	IPD/EA-TR-50	IPD/EA-TR-51
TPA	TiN	Conical	-	IPD/EA-TN-50	-	-
IPD Cerec Ti-base System		Torque value	20 Ncm			
Screwdriver	Coating	Seat				
Unigrip	TiN	Conical	-	-	IPD/EA-TR-02/TiN	-



MULTI-UNIT ABUTMENT

Angulation	Indication	Gingival Height (mm)	Uniabutment 20°/40°	Yellow ø3.0	Aqua ø3.5-4.0	Lilac ø4.5-5.0
0°	Single	1.5	-	-	IPD/EA-MR-01	IPD/EA-MW-01
		2.5	-	-	IPD/EA-MR-02	IPD/EA-MW-02
		3.5	-	-	IPD/EA-MR-03	IPD/EA-MW-03
17°	Multi-unit	4.5	-	-	IPD/EA-MR-04	IPD/EA-MW-04
		2.5	-	-	IPD/EA-MR-12	IPD/EA-MW-12
		3.5	-	-	IPD/EA-MR-13	-
30°	Multi-unit	3.5	-	-	IPD/EA-MR-33	IPD/EA-MW-33
		4.5	-	-	IPD/EA-MR-34	-
		Replacement Screw for Angled MUA				IPD/EA-MT-05

Straight Multi-unit abutments can be used for single and multiple restorations. Please see page 206 for the Multi-unit system accessories.



MULTI-UNIT AP ABUTMENT* NEW

*Check availability

Angulation	Indication	Gingival Height (mm)	Uniabutment 20°/40°	Yellow ø3.0	Aqua ø3.5-4.0	Lilac ø4.5-5.0
17°		2.5	-	-	IPD/EA-MR-12/AP	IPD/EA-MW-12/AP
		3.5	-	-	IPD/EA-MR-13/AP	IPD/EA-MW-13/AP
30°		3.5	-	-	IPD/EA-MR-33/AP	IPD/EA-MW-33/AP
		4.5	-	-	IPD/EA-MR-34/AP	IPD/EA-MW-34/AP
Replacement Screw for Angled MUA AP						IPD/KA-MT-05/BLC IPD/KA-MT-06/BLC

Please see page 206 for the Multi-unit system accessories.



ANALOGS

Type		Uniabutment 20°/40°	Yellow ø3.0	Aqua ø3.5-4.0	Lilac ø4.5-5.0
Standard		IPD/EA-AR-01	IPD/EA-AN-00	IPD/EA-AR-00	IPD/EA-AW-00
	Full set	-	IPD/EA-AN-90/3D	IPD/EA-AR-90/3D	IPD/EA-AW-90/3D
Digital	Analog				
	Bottom Screw				
	Side Screw				
Additional options	Type				
	Single hexed*	-	-	IPD/EA-AR-02	-

*Compatible with single hexed implant systems. i.e: Galimplant® IPX, Euroteknika® Naturactis



Co-Cr BASE ABUTMENT

		Uniabutment 20°/40°	Yellow ø3.0	Aqua ø3.5-4.0	Lilac ø4.5-5.0
Co-Cr Base for analogic workflow					
Indication	Angulation				
	0°	-	IPD/EA-BN-00	IPD/EA-BR-00	IPD/EA-BW-00
	15°	-	IPD/EA-BN-10	IPD/EA-BR-10	IPD/EA-BW-10
	25°	-	IPD/EA-BN-20	IPD/EA-BR-20	-
	0°	-	IPD/EA-BN-01	IPD/EA-BR-01	IPD/EA-BW-01
	15°	-	IPD/EA-BN-11	IPD/EA-BR-11	IPD/EA-BW-11
	25°	-	IPD/EA-BN-21	IPD/EA-BR-21	-
Co-Cr Base for digital workflow					
Indication	Angulation				
	Straight/ASC	-	IPD/EA-BN-00/3D	IPD/EA-BR-00/3D	IPD/EA-BW-00/3D
	Straight/ASC	-	IPD/EA-BN-01/3D	IPD/EA-BR-01/3D	IPD/EA-BW-01/3D
Scan Body		-	IPD/SC-AN-B1	IPD/SC-AN-B1	IPD/SC-AN-B1

All ASC CoCr analogic workflow abutments include the relevant TPA screw.



CASTABLE ABUTMENT

Indication		Uniabutment 20°/40°	Yellow ø3.0	Aqua ø3.5-4.0	Lilac ø4.5-5.0
		-	-	IPD/EA-HR-00	IPD/EA-HW-00
		IPD/EA-RR-01	-	IPD/EA-RR-00	IPD/EA-RW-00



PSD OVERDENTURE ABUTMENT

Indication	Gingival Height (mm)	Uniabutment 20°/40°	Yellow ø3.0	Aqua ø3.5-4.0	Lilac ø4.5-5.0
	1.0	-	-	IPD/EA-LR-01	IPD/EA-LW-01
	2.0	-	-	IPD/EA-LR-02	IPD/EA-LW-02
	3.0	-	-	IPD/EA-LR-03	IPD/EA-LW-03
	4.0	-	-	IPD/EA-LR-04	IPD/EA-LW-04
	5.0	-	-	IPD/EA-LR-05	IPD/EA-LW-05

Please see page 205 for the PSD system accessories.



COPING ABUTMENT

Type	Uniabutment 20°/40°	Yellow ø3.0	Aqua ø3.5-4.0	Lilac ø4.5-5.0
Open tray	-	IPD/EA-CN-00	-	-
Classic Design				



TEMPORARY ABUTMENT / OPEN TRAY COPING

Indication	Gingival Height (mm)	Uniabutment 20°/40°	Yellow ø3.0	Aqua ø3.5-4.0	Lilac ø4.5-5.0
	1.5	-	IPD/EA-PN-06	IPD/EA-PR-06	IPD/EA-PW-06
	1.5	-	IPD/EA-PN-07	IPD/EA-PR-07	IPD/EA-PW-07
Long coping screw		-	IPD/EA-TN-00/C	IPD/EA-TR-00/C	IPD/EA-TW-00/C

The same abutment can be used as a temporary abutment with the occlusal screw or as an impression coping using the coping screw.



HEALING ABUTMENT

Gingival Height (mm)	Uniabutment 20°/40°	Yellow ø3.0	Aqua ø3.5-4.0	Lilac ø4.5-5.0
Head Diameter (mm)			ø3.6	ø4.6
2.0	-	-	IPD/EA-DR-02	IPD/EA-DW-02
4.0	-	-	IPD/EA-DR-04	IPD/EA-DW-04
6.0	-	-	IPD/EA-DR-06	IPD/EA-DW-06
8.0	-	-	IPD/EA-DR-08	IPD/EA-DW-08
10.0	-	-	IPD/EA-DR-10	-



Ti CEMENT-RETAINED ABUTMENT

Indication	Angulation	Gingival Height (mm)	Uniabutment 20°/40°	Yellow ø3.0	Aqua ø3.5-4.0	Lilac ø4.5-5.0
	0°	2.0	-	-	IPD/EA-PR-00	IPD/EA-PW-00



SCREWDRIVERS

Type	Length (mm)	Uniabutment 20°/40°	Yellow ø3.0	Aqua ø3.5-4.0	Lilac ø4.5-5.0
Implant system Screwdriver					
1.27 Hex	18	IPD/PH-27-18	IPD/PH-27-18	IPD/PH-27-18	IPD/PH-27-18
	25	IPD/PH-27-25	IPD/PH-27-25	IPD/PH-27-25	IPD/PH-27-25
	32	IPD/PH-27-32	IPD/PH-27-32	IPD/PH-27-32	IPD/PH-27-32
IPD Scan Body and extra Screwdrivers					
1.20 Hex	18	-	IPD/PH-20-18	IPD/PH-20-18	IPD/PH-20-18
	25	-	IPD/PH-20-25	IPD/PH-20-25	IPD/PH-20-25
	32	-	IPD/PH-20-32	IPD/PH-20-32	IPD/PH-20-32
ASC Screwdriver					
TPA	18	IPD/KA-CT-18	IPD/KA-CT-18	IPD/KA-CT-18	IPD/KA-CT-18
	25	IPD/KA-CT-25	IPD/KA-CT-25	IPD/KA-CT-25	IPD/KA-CT-25
	32	IPD/KA-CT-32	IPD/KA-CT-32	IPD/KA-CT-32	IPD/KA-CT-32
PSD Screwdriver					
PSD	25	-	-	IPD/LL-PS-00	IPD/LL-PS-00



ACCESSORIES

Indication	Length (mm)	Uniabutment 20°/40°	Yellow ø3.0	Aqua ø3.5-4.0	Lilac ø4.5-5.0
Clinical RA Shank Handle	16	IPD/MC-00-16	IPD/MC-00-16	IPD/MC-00-16	IPD/MC-00-16
Laboratory RA Shank Handle	70	IPD/ML-00-70	IPD/ML-00-70	IPD/ML-00-70	IPD/ML-00-70
RA Shank Ratchet	90	IPD/DI-00-90	IPD/DI-00-90	IPD/DI-00-90	IPD/DI-00-90
Ratchet adapter		IPD/DI-KA-90	IPD/DI-KA-90	IPD/DI-KA-90	IPD/DI-KA-90
PSD and insert extractor tool		-	-	IPD/LL-PS-01	IPD/LL-PS-01

Please see page 210 for more information.



ASTRA®

EB EVOLUTION®

Prosthetic platform [XS ø3.0 / S ø3.6 / M ø4.2 / L ø4.8 / XL ø5.4]

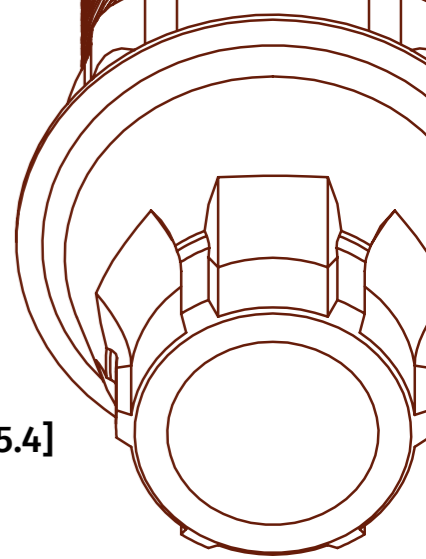

SCAN BODY NEW

*Check availability

Indication	Height (mm)	XS ø3.0	S ø3.6	M ø4.2	L ø4.8	XL ø5.4
Scan Body	10	IPD/EB-ST-00	IPD/EB-SN-00	IPD/EB-SR-00	IPD/EB-SW-00	IPD/EB-SX-00
	15	IPD/EB-ST-02	IPD/EB-SN-02	IPD/EB-SR-02	IPD/EB-SW-02	-
	10	IPD/EB-ST-01	IPD/EB-SN-01	IPD/EB-SR-01	IPD/EB-SW-01	-

Captive screw included. 1.20 Hex Screwdriver.



Ti-BASE ipd Custom Ti-Base System®

Indication	Gingival Height (mm)	XS ø3.0	S ø3.6	M ø4.2	L ø4.8	XL ø5.4
Single crown	0.5	IPD/EB-IT-00/3D	IPD/EB-IN-00/3D	IPD/EB-IR-00/3D	IPD/EB-IW-00/3D	-
	1.5	IPD/EB-IT-02/3D	IPD/EB-IN-02/3D	IPD/EB-IR-02/3D	IPD/EB-IW-02/3D	-
	2.5	IPD/EB-IT-04/3D	IPD/EB-IN-04/3D	IPD/EB-IR-04/3D	IPD/EB-IW-04/3D	-
	3.5	-	IPD/EB-IN-06/3D	IPD/EB-IR-06/3D	-	-
	Cutting guide KIT		IPD/KT-IN-00	IPD/KT-IN-00	IPD/KT-IR-00	IPD/KT-IW-00
Full arch	0.5	IPD/EB-IT-01/3D	IPD/EB-IN-01/3D	IPD/EB-IR-01/3D	IPD/EB-IW-01/3D	-
	1.5	IPD/EB-IT-03/3D	IPD/EB-IN-03/3D	IPD/EB-IR-03/3D	IPD/EB-IW-03/3D	-
	2.5	IPD/EB-IT-05/3D	IPD/EB-IN-05/3D	IPD/EB-IR-05/3D	IPD/EB-IW-05/3D	-
	3.5	-	IPD/EB-IN-07/3D	IPD/EB-IR-07/3D	-	-
	Cutting guide KIT		IPD/KT-IN-01	IPD/KT-IN-01	IPD/KT-IR-01	IPD/KT-IW-01

Please see page 204 for the IPD Custom Interface System accessories.



CEREC® TI-BASE SYSTEM

Indication	Gingival Height (mm)	XS ø3.0	S ø3.6	M ø4.2	L ø4.8	XL ø5.4
Single crown	0.5	-	IPD/EB-IN-00/SI	IPD/EB-IR-00/SI	-	-
	1.5	-	IPD/EB-IN-02/SI	IPD/EB-IR-02/SI	-	-
	2.5	-	IPD/EB-IN-04/SI	IPD/EB-IR-04/SI	-	-
Cerec Block (S/L)		-	S	L	-	-
Cerec Library Code		-	B C 3.4	B C 4.1	-	-

TiN screw included.



[RETURN TO INDEX](#)

IPDMILLED SYSTEM* **NEW**

*Check availability

Indication	Material	Diameter (mm)	XS ø3.0	S ø3.6	M ø4.2	L ø4.8	XL ø5.4
IPD Blank System (Compatible with NT/IPD Holders)							
	Ti	12	IPD/EB-XT-00	IPD/EB-XN-00	IPD/EB-XR-00	IPD/EB-XW-00	IPD/EB-XX-00
Mill Analog			IPD/EB-AT-00/X	IPD/EB-AN-00/X	IPD/EB-AR-00/X	IPD/EB-AW-00/X	IPD/EB-AX-00/X
TYPE A System (Compatible with DESS® Holders)							
	Ti	15	PR/EB-XT-15/A	PR/EB-XN-15/A	PR/EB-XR-15/A	PR/EB-XW-15/A	-

All premilled abutments include 2 titanium screws.



SCREWS

			XS ø3.0	S ø3.6	M ø4.2	L ø4.8	XL ø5.4
IPD and OEM compatible For straight channels			25 Ncm	25 Ncm	25 Ncm	25 Ncm	25 Ncm
Screwdriver	Coating	Seat					
1.27 Hex	-	Conical	IPD/EB-TT-00	IPD/EB-TN-00	IPD/EB-TR-00	IPD/EB-TW-00	IPD/EB-TW-00
1.27 Hex	TiN	Conical	IPD/EB-TT-00/TiN	IPD/EB-TN-00/TiN	IPD/EB-TR-00/TiN	IPD/EB-TW-00/TiN	IPD/EB-TW-00/TiN
1.27 Hex	BLC	Conical	IPD/EB-TT-00/BLC	IPD/EB-TN-00/BLC	IPD/EB-TR-00/BLC	IPD/EB-TW-00/BLC	IPD/EB-TW-00/BLC
	For ASC options	Torque value	15 Ncm	20 Ncm	25 Ncm	25 Ncm	
Screwdriver	Coating	Seat					
TPA	TiN	Conical	IPD/EB-TT-50	IPD/EB-TN-50	IPD/EB-TR-50	IPD/EB-TW-50	-
IPDmilled compatible			25 Ncm	25 Ncm	25 Ncm	25 Ncm	25 Ncm
Screwdriver	Coating	Seat					
1.27 Hex	-	Conical	IPD/EB-TT-00	IPD/EB-TN-00	IPD/EB-TR-00/X	IPD/EB-TW-00	IPD/EB-TW-00

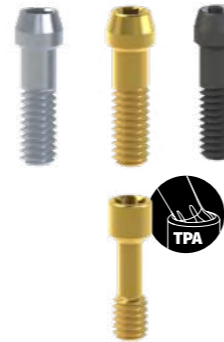

MULTI-UNIT ABUTMENT

Angulation	Indication	Gingival Height (mm)	XS ø3.0	S ø3.6	M ø4.2	L ø4.8	XL ø5.4
0°		1.5	IPD/EB-MT-01	IPD/EB-MN-01	IPD/EB-MR-01	IPD/EB-MW-01	-
		2.5	IPD/EB-MT-02	IPD/EB-MN-02	IPD/EB-MR-02	IPD/EB-MW-02	-
		3.5	IPD/EB-MT-03	IPD/EB-MN-03	IPD/EB-MR-03	IPD/EB-MW-03	-
17°		2.5	-	IPD/EB-MN-12	IPD/EB-MR-12	-	-
		3.5	-	-	IPD/EB-MR-13	-	-
30°		3.5	-	IPD/EB-MN-33	IPD/EB-MR-33	-	-
	Replacement Screw for Angled MUA			IPD/KA-MT-04	IPD/KA-MT-08	-	-

Straight Multi-unit abutments can be used for single and multiple restorations. Please see page 206 for the Multi-unit system accessories.



MULTI-UNIT AP ABUTMENT* **NEW**

*Check availability

Angulation	Indication	Gingival Height (mm)	XS ø3.0	S ø3.6	M ø4.2	L ø4.8	XL ø5.4
17°		2.5	IPD/EB-MT-12/AP	IPD/EB-MN-12/AP	IPD/EB-MR-12/AP	IPD/EB-MW-12/AP	-
		3.5	IPD/EB-MT-13/AP	IPD/EB-MN-13/AP	IPD/EB-MR-13/AP	IPD/EB-MW-13/AP	-
30°		3.5	IPD/EB-MT-33/AP	IPD/EB-MN-33/AP	IPD/EB-MR-33/AP	IPD/EB-MW-33/AP	-
		4.5	IPD/EB-MT-34/AP	IPD/EB-MN-34/AP	IPD/EB-MR-34/AP	IPD/EB-MW-34/AP	-
	Replacement Screw for Angled MUA AP		IPD/KA-MT-13/BLC	IPD/KA-MT-04/BLC	IPD/KA-MT-08/BLC	IPD/KA-MT-08/BLC	-

Please see page 206 for the Multi-unit system accessories.



ANALOGS

Type		XS ø3.0	S ø3.6	M ø4.2	L ø4.8	XL ø5.4
Standard		IPD/EB-AT-00	IPD/EB-AN-00	IPD/EB-AR-00	IPD/EB-AW-00	-
	Full set	IPD/EB-AT-90/3D	IPD/EB-AN-90/3D	IPD/EB-AR-90/3D	IPD/EB-AW-90/3D	-
Digital	Analog					
	Bottom Screw					
	Side Screw					



Co-Cr BASE ABUTMENT

		XS ø3.0	S ø3.6	M ø4.2	L ø4.8	XL ø5.4
Co-Cr Base for analogic workflow						
Indication	Angulation					
	0°	-	IPD/EB-BN-00	IPD/EB-BR-00	-	-
	15°	-	IPD/EB-BN-10	IPD/EB-BR-10	-	-
	25°	-	IPD/EB-BN-20	-	-	-
	0°	-	IPD/EB-BN-01	IPD/EB-BR-01	-	-
	15°	-	IPD/EB-BN-11	IPD/EB-BR-11	-	-
	25°	-	IPD/EB-BN-21	-	-	-
Co-Cr Base for digital workflow						
Indication	Angulation					
	Straight/ASC	-	IPD/EB-BN-00/3D	IPD/EB-BR-00/3D	-	-
	Straight/ASC		IPD/EB-BN-01/3D	IPD/EB-BR-01/3D	-	-
Scan Body			IPD/SC-AN-B1	IPD/SC-AN-B1	-	-

All ASC CoCr analogic workflow abutments include the relevant TPA screw.



PSD OVERDENTURE ABUTMENT

Indication	Gingival Height (mm)	XS ø3.0	S ø3.6	M ø4.2	L ø4.8	XL ø5.4
	1.0	IPD/EB-LT-01	IPD/EB-LN-01	IPD/EB-LR-01	IPD/EB-LW-01	-
	3.0	IPD/EB-LT-03	IPD/EB-LN-03	IPD/EB-LR-03	IPD/EB-LW-03	-
	5.0	IPD/EB-LT-05	IPD/EB-LN-05	IPD/EB-LR-05	IPD/EB-LW-05	-

Please see page 205 for the PSD system accessories.



TEMPORARY ABUTMENT / OPEN TRAY COPING

Indication	Gingival Height (mm)	XS ø3.0	S ø3.6	M ø4.2	L ø4.8	XL ø5.4
	1.5	IPD/EB-PT-06	IPD/EB-PN-06	IPD/EB-PR-06	IPD/EB-PW-06	-
	1.5	IPD/EB-PT-07	IPD/EB-PN-07	IPD/EB-PR-07	IPD/EB-PW-07	-
Long coping screw		IPD/EB-TT-00/C	IPD/EB-TN-00/C	IPD/EB-TR-00/C	IPD/EB-TW-00/C	-

The same abutment can be used as a temporary abutment with the occlusal screw or as an impression coping using the coping screw.



HEALING ABUTMENT

Gingival Height (mm)	Head Diameter (mm)	XS ø3.0	S ø3.6	M ø4.2	L ø4.8	XL ø5.4
		ø3.8	ø4.0	ø5.0	ø5.5	
3.5		IPD/EB-DT-03	IPD/EB-DN-03	IPD/EB-DR-03	IPD/EB-DW-03	-
4.5		IPD/EB-DT-04	IPD/EB-DN-04	IPD/EB-DR-04	IPD/EB-DW-04	-
5.5		IPD/EB-DT-05	IPD/EB-DN-05	IPD/EB-DR-05	IPD/EB-DW-05	-



SCREWDRIVERS

Type	Length (mm)	XS ϕ 3.0	S ϕ 3.6	M ϕ 4.2	L ϕ 4.8	XL ϕ 5.4
Implant system Screwdriver						
1.27 Hex	18	IPD/PH-27-18	IPD/PH-27-18	IPD/PH-27-18	IPD/PH-27-18	IPD/PH-27-18
	25	IPD/PH-27-25	IPD/PH-27-25	IPD/PH-27-25	IPD/PH-27-25	IPD/PH-27-25
	32	IPD/PH-27-32	IPD/PH-27-32	IPD/PH-27-32	IPD/PH-27-32	IPD/PH-27-32
IPD Scan Body and extra Screwdrivers						
1.20 Hex	18	IPD/PH-20-18	IPD/PH-20-18	IPD/PH-20-18	IPD/PH-20-18	IPD/PH-20-18
	25	IPD/PH-20-25	IPD/PH-20-25	IPD/PH-20-25	IPD/PH-20-25	IPD/PH-20-25
	32	IPD/PH-20-32	IPD/PH-20-32	IPD/PH-20-32	IPD/PH-20-32	IPD/PH-20-32
ASC Screwdriver						
TPA	18	IPD/KA-CT-18	IPD/KA-CT-18	IPD/KA-CT-18	IPD/KA-CT-18	-
	25	IPD/KA-CT-25	IPD/KA-CT-25	IPD/KA-CT-25	IPD/KA-CT-25	-
	32	IPD/KA-CT-32	IPD/KA-CT-32	IPD/KA-CT-32	IPD/KA-CT-32	-
PSD Screwdriver						
PSD	25	IPD/LL-PS-00	IPD/LL-PS-00	IPD/LL-PS-00	IPD/LL-PS-00	-



ACCESSORIES

Type	Length (mm)	XS ϕ 3.0	S ϕ 3.6	M ϕ 4.2	L ϕ 4.8	XL ϕ 5.4
Clinical RA Shank Handle	16	IPD/MC-00-16	IPD/MC-00-16	IPD/MC-00-16	IPD/MC-00-16	IPD/MC-00-16
Laboratory RA Shank Handle	70	IPD/ML-00-70	IPD/ML-00-70	IPD/ML-00-70	IPD/ML-00-70	IPD/ML-00-70
RA Shank Ratchet	90	IPD/DI-00-90	IPD/DI-00-90	IPD/DI-00-90	IPD/DI-00-90	IPD/DI-00-90
Ratchet adapter		IPD/DI-KA-90	IPD/DI-KA-90	IPD/DI-KA-90	IPD/DI-KA-90	IPD/DI-KA-90
PSD and insert extractor tool		IPD/LL-PS-01	IPD/LL-PS-01	IPD/LL-PS-01	IPD/LL-PS-01	-

Please see page 210 for more information.



ZIMMER®

FA SCREW VENT® Prosthetic platform [ϕ 3.5 / ϕ 4.5 / ϕ 5.7]



SCAN BODY

Indication	Height (mm)	ϕ 3.5	ϕ 4.5	ϕ 5.7
Scan Body	10	IPD/FA-SN-00	IPD/FA-SR-00	IPD/FA-SW-00
	15	IPD/FA-SN-02	IPD/FA-SR-02	IPD/FA-SW-02
	10	IPD/FA-SN-01	IPD/FA-SR-01	IPD/FA-SW-01

Captive screw included. 1.20 Hex Screwdriver.



Ti-BASE *ipd* Custom Ti-Base System®

Indication	Gingival Height (mm)	ϕ 3.5	ϕ 4.5	ϕ 5.7
Heart icon	0.5	IPD/FA-IN-00/3D	IPD/FA-IR-00/3D	IPD/FA-IW-00/3D
	1.5	IPD/FA-IN-02/3D	IPD/FA-IR-02/3D	-
	2.5	IPD/FA-IN-04/3D	IPD/FA-IR-04/3D	-
Cutting guide KIT		IPD/KT-IN-00	IPD/KT-IR-00	IPD/KT-IW-00
Mouth icon	0.5	IPD/FA-IN-01/3D	IPD/FA-IR-01/3D	IPD/FA-IW-01/3D
	1.5	IPD/FA-IN-03/3D	IPD/FA-IR-03/3D	-
	2.5	IPD/FA-IN-05/3D	IPD/FA-IR-05/3D	-
Cutting guide KIT		IPD/KT-IN-01	IPD/KT-IR-01	IPD/KT-IW-01

Please see page 204 for the IPD Custom Interface System accessories.



CEREC® TI-BASE SYSTEM

Indication	Gingival Height (mm)	ϕ 3.5	ϕ 4.5	ϕ 5.7
Heart icon	0.5	IPD/FA-IN-00/SI	IPD/FA-IR-00/SI	-
	1.5	IPD/FA-IN-02/SI	IPD/FA-IR-02/SI	-
	2.5	IPD/FA-IN-04/SI	IPD/FA-IR-04/SI	-
Cerec Block (S/L)		S	L	-
Cerec Library Code		B C 3.4	NB B 4.1	-

TiN screw included.



IPDMILLED SYSTEM* *NEW*

*Check availability

Indication	Material	Diameter (mm)	ϕ 3.5	ϕ 4.5	ϕ 5.7
IPD Blank System (Compatible with NT/IPD Holders)					
	Ti	12	IPD/FA-XN-00	IPD/FA-XR-00	IPD/FA-XW-00
Mill Analog			IPD/FA-AN-00/X	IPD/FA-AR-00/X	IPD/FA-AW-00/X
TYPE A System (Compatible with DESS® Holders)					
	Ti	15	PR/FA-XN-15/A	PR/FA-XR-15/A	-

All premilled abutments include 2 titanium screws.



RETURN TO INDEX

SCREWS

IPD and OEM compatible For straight channels			Ø3.5	Ø4.5	Ø5.7
Screwdriver	Coating	Seat	30 Ncm	30 Ncm	30 Ncm
1.25 Hex	-	Conical	IPD/FA-TR-00	IPD/FA-TR-00	IPD/FA-TR-00
1.25 Hex	TiN	Conical	IPD/FA-TR-00/TiN	IPD/FA-TR-00/TiN	IPD/FA-TR-00/TiN
1.25 Hex	BLC	Conical	IPD/FA-TR-00/BLC	IPD/FA-TR-00/BLC	IPD/FA-TR-00/BLC
For ASC options			25 Ncm	25 Ncm	25 Ncm
Screwdriver	Coating	Seat			
TPA	TiN	Conical	IPD/FA-TR-50	IPD/FA-TR-50	IPD/FA-TR-50



MULTI-UNIT ABUTMENT

Angulation	Indication	Gingival Height (mm)	Ø3.5	Ø4.5	Ø5.7
0°		0.9	IPD/FA-MN-00	-	-
		1.5	IPD/FA-MN-01	IPD/FA-MR-01	-
		2.5	IPD/FA-MN-02	IPD/FA-MR-02	-
		3.5	IPD/FA-MN-03	IPD/FA-MR-03	-
		4.5	IPD/FA-MN-04	IPD/FA-MR-04	-
17°		2.5	IPD/FA-MN-12	-	-
		3.0	-	IPD/FA-MR-13	-
		3.5	IPD/FA-MN-13	-	-
30°		4.0	-	IPD/FA-MR-14	-
		3.5	IPD/FA-MN-33	IPD/FA-MR-33	-
		4.5	IPD/FA-MN-34	IPD/FA-MR-34	-
Replacement Screw for Angled MUA			IPD/KA-MT-08	IPD/KA-MT-08	-

Straight Multi-unit abutments can be used for single and multiple restorations. Please see page 206 for the Multi-unit system accessories.



MULTI-UNIT AP ABUTMENT* NEW

*Check availability

Angulation	Indication	Gingival Height (mm)	Ø3.5	Ø4.5	Ø5.7
17°		2.5	IPD/FA-MN-12/AP	IPD/FA-MR-12/AP	-
		3.5	IPD/FA-MN-13/AP	IPD/FA-MR-13/AP	-
30°		3.5	IPD/FA-MN-33/AP	IPD/FA-MR-33/AP	-
		4.5	IPD/FA-MN-34/AP	IPD/FA-MR-34/AP	-
Replacement Screw for Angled MUA AP			IPD/KA-MT-08/BLC	IPD/KA-MT-08/BLC	-

Please see page 206 for the Multi-unit system accessories.



ANALOGS

Type	Ø3.5	Ø4.5	Ø5.7
Standard	IPD/FA-AN-00	IPD/FA-AR-00	IPD/FA-AW-00
	Full set	IPD/FA-AN-90/3D	IPD/FA-AR-90/3D
Digital		Analog	
		Bottom Screw	
		Side Screw	



Co-Cr BASE ABUTMENT

		Ø3.5	Ø4.5	Ø5.7
Co-Cr Base for analogic workflow				
Indication	Angulation			
	0°	IPD/FA-BN-00	IPD/FA-BR-00	-
	15°	IPD/FA-BN-10	IPD/FA-BR-10	-
	25°	IPD/FA-BN-20	IPD/FA-BR-20	-
	0°	IPD/FA-BN-01	IPD/FA-BR-01	-
	15°	IPD/FA-BN-11	IPD/FA-BR-11	-
	25°	IPD/FA-BN-21	IPD/FA-BR-21	-
Co-Cr Base for digital workflow				
Indication	Angulation			
	Straight/ASC	IPD/FA-BN-00/3D	-	-
	Straight	-	IPD/FA-BR-00/3D	-
	ASC	-	IPD/FA-BR-A0/3D	-
	Straight / ASC	IPD/FA-BN-01/3D	-	-
	Straight	-	IPD/FA-BR-01/3D	-
	ASC	-	IPD/FA-BR-A1/3D	-
Scan Body		IPD/SC-AN-B1	IPD/SC-AN-B1	-

All ASC CoCr analogic workflow abutments include the relevant TPA screw.



CASTABLE ABUTMENT

Indication	Ø3.5	Ø4.5	Ø5.7
	IPD/FA-HN-00	IPD/FA-HR-00	IPD/FA-HW-00
	IPD/FA-RN-00	IPD/FA-RR-00	IPD/FA-RW-00



PSD OVERDENTURE ABUTMENT

Indication	Gingival Height (mm)	Ø3.5	Ø4.5	Ø5.7
	1.0	IPD/FA-LN-01	IPD/FA-LR-01	-
	2.0	IPD/FA-LN-02	IPD/FA-LR-02	-
	3.0	IPD/FA-LN-03	IPD/FA-LR-03	-
	4.0	IPD/FA-LN-04	IPD/FA-LR-04	-
	5.0	IPD/FA-LN-05	IPD/FA-LR-05	-

Please see page 205 for the PSD system accessories.



COPING ABUTMENT

Type	Ø3.5	Ø4.5	Ø5.7
Open tray	IPD/FA-CN-00	-	IPD/FA-CW-00

Classic Design



TEMPORARY ABUTMENT / OPEN TRAY COPING

Indication	Gingival Height (mm)	Ø3.5	Ø4.5	Ø5.7
	1.5	IPD/FA-PN-06	IPD/FA-PR-06	IPD/FA-PW-06
	1.5	IPD/FA-PN-07	IPD/FA-PR-07	IPD/FA-PW-07
Long coping screw		IPD/FA-TR-00/C	IPD/FA-TR-00/C	IPD/FA-TR-00/C

The same abutment can be used as a temporary abutment with the occlusal screw or as an impression coping using the coping screw.



HEALING ABUTMENT

Gingival Height (mm)		Ø3.5	Ø4.5	Ø5.7
	Head Diameter (mm)	Ø4.0	Ø4.5	Ø6.5
1.5		IPD/FA-DN-01	IPD/FA-DR-01	-
3.0		IPD/FA-DN-03	IPD/FA-DR-03	IPD/FA-DW-03
5.0		IPD/FA-DN-05	IPD/FA-DR-05	IPD/FA-DW-05



TI CEMENT-RETAINED ABUTMENT

Indication	Angulation	Gingival Height	Ø3.5	Ø4.5	Ø5.7
🦷	0°	1.0	IPD/FA-PN-00	-	-
		2.0	IPD/FA-PN-01	-	-
	15°	1.0	IPD/FA-PN-02	-	-
		2.0	IPD/FA-PN-03	-	-
	25°	1.0	IPD/FA-PN-04	-	-
		2.0	IPD/FA-PN-05	-	-

Using the Low profile IPD/AA-TR-01 screw for IPD/AA-PR-04 is recommended



SCREWDRIVERS

Type	Length (mm)	Ø3.5	Ø4.5	Ø5.7
Implant system Screwdriver				
1.25 Hex	18	IPD/PH-25-18	IPD/PH-25-18	IPD/PH-25-18
	25	IPD/PH-25-25	IPD/PH-25-25	IPD/PH-25-25
	32	IPD/PH-25-32	IPD/PH-25-32	IPD/PH-25-32
IPD Scan Body and extra Screwdrivers				
1.20 Hex	18	IPD/PH-20-18	IPD/PH-20-18	IPD/PH-20-18
	25	IPD/PH-20-25	IPD/PH-20-25	IPD/PH-20-25
	32	IPD/PH-20-32	IPD/PH-20-32	IPD/PH-20-32
ASC Screwdriver				
TPA	18	IPD/KA-CT-18	IPD/KA-CT-18	IPD/KA-CT-18
	25	IPD/KA-CT-25	IPD/KA-CT-25	IPD/KA-CT-25
	32	IPD/KA-CT-32	IPD/KA-CT-32	IPD/KA-CT-32
PSD Screwdriver				
PSD	25	IPD/LL-PS-00	IPD/LL-PS-00	-



ACCESSORIES

Indication	Length (mm)	Ø3.5	Ø4.5	Ø5.7
Clinical RA Shank Handle	16	IPD/MC-00-16	IPD/MC-00-16	IPD/MC-00-16
Laboratory RA Shank Handle	70	IPD/ML-00-70	IPD/ML-00-70	IPD/ML-00-70
RA Shank Ratchet	90	IPD/DI-00-90	IPD/DI-00-90	IPD/DI-00-90
Ratchet adapter		IPD/DI-KA-90	IPD/DI-KA-90	IPD/DI-KA-90
PSD and insert extractor tool		IPD/LL-PS-01	IPD/LL-PS-01	-

Please see page 210 for more information.



ZIMMER®

FB SWISSPLUS®

Prosthetic platform [SynOcta RN Ø4.8 / Ø4.8]



SCAN BODY

	Indication	Height (mm)	SynOcta RN Ø4.8	Ø4.8
Scan Body	🦷	10	-	IPD/DA-SR-00
	🦷	15	-	IPD/DA-SR-02
	🦷🦷	10	-	IPD/DA-SR-01

Captive screw included. 1.20 Hex Screwdriver.



Ti-BASE ipd Custom Ti-Base System®

Indication	Gingival Height (mm)	SynOcta RN Ø4.8	Ø4.8
🦷	0.4	-	IPD/DA-IR-00/3D
		Cutting guide KIT	
🦷🦷	0.4	-	IPD/DA-IR-01/3D
		Cutting guide KIT	
			IPD/KT-IR-01

Please see page 204 for the IPD Custom Interface System accessories.



IPDMILLED SYSTEM* NEW

*Check availability

Indication	Material	Diameter (mm)	SynOcta RN Ø4.8	Ø4.8
IPD Blank System (Compatible with NT/IPD Holders)				
	Ti	12	-	IPD/DA-XR-00
Mill Analog			-	IPD/DA-AR-00/X
TYPE A System (Compatible with DESS® Holders)				
	Ti	15	-	PR/DA-XR-15/A

All premilled abutments include 2 titanium screws.



RETURN TO INDEX

SCREWS

			SynOcta RN ϕ 4.8	ϕ 4.8
IPD compatible	For straight channels	Torque value	35 Ncm	35 Ncm
Screwdriver	Coating	Seat		
1.25 Hex	-	Conical	-	IPD/FB-TR-01
1.25 Hex	TiN	Conical	-	IPD/FB-TR-01/TiN
1.25 Hex	BLC	Conical	-	IPD/FB-TR-01/BLC
Torx	-	Conical	IPD/DA-TR-00	-
Torx	TiN	Conical	IPD/DA-TR-00/TiN	-
Torx	BLC	Conical	IPD/DA-TR-00/BLC	-
			25 Ncm	25 Ncm
Screwdriver	Coating	Seat		
TPA	TiN	Conical	IPD/DA-TR-50	IPD/DA-TR-51
			35 Ncm	35 Ncm
OEM compatible	For ASC options	Torque value	35 Ncm	35 Ncm
Screwdriver	Coating	Seat		
1.25 Hex	-	Conical	-	IPD/FB-TR-00
1.25 Hex	TiN	Conical	-	IPD/FB-TR-00/TiN
1.25 Hex	BLC	Conical	-	IPD/FB-TR-00/BLC
Torx	-	Conical	IPD/DA-TR-00	-
Torx	TiN	Conical	IPD/DA-TR-00/TiN	-
Torx	BLC	Conical	IPD/DA-TR-00/BLC	-
				35 Ncm
IPDmilled compatible		Torque value		35 Ncm
Screwdriver	Coating	Seat		
Torx	-	Conical	-	IPD/DA-TR-01/X

MULTI-UNIT ABUTMENT

Angulation	Indication	Gingival Height (mm)	SynOcta RN ϕ 4.8	ϕ 4.8
0°		0.9	-	IPD/DA-MR-01

Straight Multi-unit abutments can be used for single and multiple restorations. Please see page 206 for the Multi-unit system accessories.

ANALOGS

Type	SynOcta RN ϕ 4.8	ϕ 4.8
Standard	IPD/DA-AR-01	IPD/DA-AR-00
	Full set	IPD/DA-AR-90/3D
Digital	Analog	
	Bottom Screw	
	Side Screw	



Co-Cr BASE ABUTMENT

		SynOcta RN ϕ 4.8	ϕ 4.8
Co-Cr Base for analogic workflow			
Indication	Angulation		
	0°	IPD/DA-BR-03	IPD/DA-BR-00
	15°	IPD/DA-BR-13	IPD/DA-BR-10
	25°	-	IPD/DA-BR-20
	0°	IPD/DA-BR-02	IPD/DA-BR-01
	15°	IPD/DA-BR-12	IPD/DA-BR-11
	25°	-	IPD/DA-BR-21
Co-Cr Base for digital workflow			
Indication	Angulation		
	Straight/ASC	IPD/DA-BR-03/3D	IPD/DA-BR-00/3D
	Straight/ASC	IPD/DA-BR-02/3D	IPD/DA-BR-01/3D
	Scan Body	IPD/SC-AN-B2	IPD/SC-AN-B2

All ASC CoCr analogic workflow abutments include the relevant TPA screw.



CASTABLE ABUTMENT

Indication	SynOcta RN ϕ 4.8	ϕ 4.8
	IPD/DA-HR-00	IPD/DA-HR-01
	IPD/DA-RR-00	IPD/DA-RR-01



PSD OVERDENTURE ABUTMENT

Indication	Gingival Height (mm)	SynOcta RN ϕ 4.8	ϕ 4.8
	1.0	-	IPD/DA-LR-01
	2.0	-	IPD/DA-LR-02
	3.0	-	IPD/DA-LR-03

Please see page 205 for the PSD system accessories.



TEMPORARY ABUTMENT / OPEN TRAY COPING

Indication	Gingival Height (mm)	SynOcta RN ϕ 4.8	ϕ 4.8
	1.5	IPD/DA-PR-09	IPD/DA-PR-06
	1.5	IPD/DA-PR-08	IPD/DA-PR-07
	Long coping screw	IPD/DA-TR-00/C	IPD/DA-TR-01/C

The same abutment can be used as a temporary abutment with the occlusal screw or as an impression coping using the coping screw.



HEALING ABUTMENT

Gingival Height (mm)	SynOcta RN ϕ 4.8	ϕ 4.8
	Head Diameter (mm)	ϕ 5.5
Sealing cap	-	IPD/DA-DR-00
1.5	-	IPD/DA-DR-01
3.0	-	IPD/DA-DR-03
4.5	-	IPD/DA-DR-04



Ti CEMENT-RETAINED ABUTMENT

Indication	Angulation	Gingival Height	SynOcta RN ϕ 4.8	ϕ 4.8
	0°	2.0	-	IPD/DA-PR-01

SYNOCTA ABUTMENT

Indication	Angulation	SynOcta RN ϕ 4.8	ϕ 4.8
	0°	-	IPD/DA-PR-00

SCREWDRIVERS

Type	Length (mm)	SynOcta RN ϕ 4.8	ϕ 4.8
Implant system Screwdriver			
1.25 Hex	18	IPD/PH-25-18	IPD/PH-25-18
	25	IPD/PH-25-25	IPD/PH-25-25
	32	IPD/PH-25-32	IPD/PH-25-32
Torx	18	IPD/PT-00-18	IPD/PT-00-18
	25	IPD/PT-00-25	IPD/PT-00-25
	32	IPD/PT-00-32	IPD/PT-00-32
IPD Scan Body and extra Screwdrivers			
1.20 Hex	18	IPD/PH-20-18	IPD/PH-20-18
	25	IPD/PH-20-25	IPD/PH-20-25
	32	IPD/PH-20-32	IPD/PH-20-32
ASC Screwdriver			
TPA	18	IPD/KA-CT-18	IPD/KA-CT-18
	25	IPD/KA-CT-25	IPD/KA-CT-25
	32	IPD/KA-CT-32	IPD/KA-CT-32
	32	IPD/KA-CT-32	IPD/KA-CT-32
PSD Screwdriver			
PSD	25	-	IPD/LL-PS-00

ACCESSORIES

Indication	Length (mm)	SynOcta RN ϕ 4.8	ϕ 4.8
Clinical RA Shank Handle	16	IPD/MC-00-16	IPD/MC-00-16
Laboratory RA Shank Handle	70	IPD/ML-00-70	IPD/ML-00-70
RA Shank Ratchet	90	IPD/DI-00-90	IPD/DI-00-90
Ratchet adapter		IPD/DI-KA-90	IPD/DI-KA-90
PSD and insert extractor tool		-	IPD/LL-PS-01

Please see page 210 for more information.



ZIMMER®

FC EZTETIC® Prosthetic platform [NP ϕ 3.1]

SCAN BODY

	Indication	Height (mm)	NP ϕ 3.1
Scan Body		10	IPD/FC-ST-00
		15	IPD/FC-ST-02
		10	IPD/FC-ST-01

Captive screw included. H 1,20 Screwdriver.



Ti-BASE Custom Ti-Base System®

Indication	Gingival Height (mm)	NP ϕ 3.1
	1.0	IPD/FC-IT-00/3D
	2.0	IPD/FC-IT-02/3D
	3.0	IPD/FC-IT-04/3D
Cutting guide KIT		IPD/KT-IN-00
	1.0	IPD/FC-IT-01/3D
	2.0	IPD/FC-IT-03/3D
	3.0	IPD/FC-IT-05/3D
Cutting guide KIT		IPD/KT-IN-01

Please see page 204 for the IPD Custom Interface System accessories.



SCREWS

IPD and OEM compatible		Torque value	NP ϕ 3.1
For straight channels		30 Ncm	
Screwdriver	Coating	Seat	
1.25 Hex	-	Conical	IPD/FC-TT-00
1.25 Hex	TiN	Conical	IPD/FC-TT-00/TiN
1.25 Hex	BLC	Conical	IPD/FC-TT-00/BLC
For ASC options		20 Ncm	
Screwdriver	Coating	Seat	
TPA	TiN	Conical	IPD/FC-TT-50



[RETURN TO INDEX](#)

MULTI-UNIT ABUTMENT

Angulation	Indication	Gingival Height (mm)	NP ø3.1
0°		1.5	IPD/FC-MT-01
		2.5	IPD/FC-MT-02
		3.5	IPD/FC-MT-03
17°		2.5	IPD/FC-MT-12
30°		3.5	IPD/FC-MT-33
Replacement Screw for Angled MUA			IPD/KA-MT-05

Straight Multi-unit abutments can be used for single and multiple restorations. Please see page 206 for the Multi-unit system accessories.



ANALOGS

Type	NP ø3.1
Standard	IPD/FC-AT-00
	Full set IPD/FC-AT-90/3D
Digital	Analog Bottom Screw Side Screw



Co-Cr BASE ABUTMENT

Co-Cr Base for analogic workflow		NP ø3.1
Indication	Angulation	
	0°	IPD/FC-BT-00
	15°	IPD/FC-BT-10
	0°	IPD/FC-BT-01
	15°	IPD/FC-BT-11
Co-Cr Base for digital workflow		
Indication	Angulation	
	Straight/ASC	IPD/FC-BT-00/3D
	Straight/ASC	IPD/FC-BT-01/3D
Scan Body		IPD/SC-AN-B1

All ASC CoCr analogic workflow abutments include the relevant TPA screw.



PSD OVERDENTURE ABUTMENT

Indication	Gingival Height (mm)	NP ø3.1
	2.0	IPD/FC-LT-02
	3.0	IPD/FC-LT-03
	4.0	IPD/FC-LT-04
	5.0	IPD/FC-LT-05

Please see page 205 for the PSD system accessories.



TEMPORARY ABUTMENT / OPEN TRAY COPING

Indication	Gingival Height (mm)	NP ø3.1
	1.5	IPD/FC-PT-06
	1.5	IPD/FC-PT-07
Long coping screw		IPD/FC-TT-00/C

The same abutment can be used as a temporary abutment with the occlusal screw or as an impression coping using the coping screw.



HEALING ABUTMENT

Gingival Height (mm)	Head Diameter (mm)	NP ø3.1
1.0	ø3.8	IPD/FC-DT-01
2.5		IPD/FC-DT-02
4.0		IPD/FC-DT-04



SCREWDRIVERS

Type	Length (mm)	NP ø3.1
Implant system Screwdriver		
1.25 Hex	18	IPD/PH-25-18
	25	IPD/PH-25-25
	32	IPD/PH-25-32
IPD Data markers and extras Screwdriver		
1.20 Hex	18	IPD/PH-20-18
	25	IPD/PH-20-25
	32	IPD/PH-20-32
ASC Screwdriver		
TPA	18	IPD/KA-CT-18
	25	IPD/KA-CT-25
	32	IPD/KA-CT-32
PSD Screwdriver		
PSD	25	IPD/LL-PS-00



ACCESSORIES

Indication	Length (mm)	NP ø3.1
Clinical RA Shank Handle	16	IPD/MC-00-16
Laboratory RA Shank Handle	70	IPD/ML-00-70
RA Shank Ratchet	90	IPD/DI-00-90
Ratchet adapter		IPD/DI-KA-90
PSD and insert extractor tool		IPD/LL-PS-01

Please see page 210 for more information.



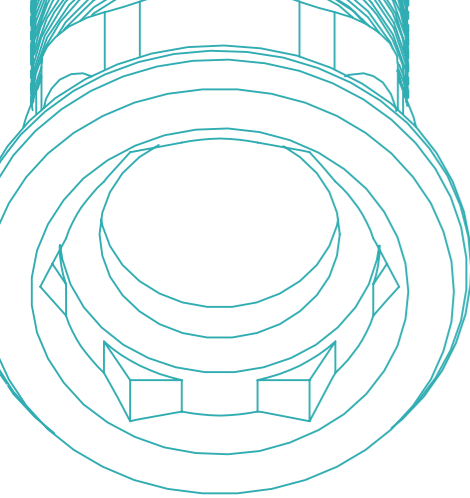

BTI®

GA EXTERNAL

Prosthetic platform [Estrecha® ø3.5 / Universal ø4.1 / Ancha ø5.5]

SCAN BODY

Indication	Height (mm)	Estrecha® ø3.5	Universal ø4.1	Ancha ø5.5
Scan Body	10	IPD/GA-SN-00	IPD/AA-SR-00	-
	15	IPD/GA-SN-02	IPD/AA-SR-02	-
	10	IPD/GA-SN-01	IPD/AA-SR-01	-

Captive screw included. 1.20 Hex Screwdriver.



Ti-BASE **ipd** Custom Ti-Base System®

Indication	Gingival Height (mm)	Estrecha® ø3.5	Universal ø4.1	Ancha ø5.5
Single crown	0.5	-	IPD/AA-IR-00/3D	-
	1.5	IPD/GA-IN-02/3D	IPD/AA-IR-02/3D	-
	2.5	-	IPD/AA-IR-04/3D	-
	Cutting guide KIT		IPD/KT-IN-00	IPD/KT-IR-00
Full arch	0.5	-	IPD/AA-IR-01/3D	-
	1.5	IPD/GA-IN-03/3D	IPD/AA-IR-03/3D	-
	2.5	-	IPD/AA-IR-05/3D	-
	Cutting guide KIT		IPD/KT-IN-01	IPD/KT-IR-01

Please see page 204 for the IPD Custom Interface System accessories.



IPDMILLED SYSTEM* **NEW**

*Check availability

Indication	Material	Diameter (mm)	Estrecha® ø3.5	Universal ø4.1	Ancha ø5.5
TYPE A System (Compatible with DESS® Holders)	Ti	15	-	PR/AA-XR-15/A	-

All premilled abutments include 2 titanium screws.



SCREWS

IPD and OEM compatible	For straight channels	Torque value	Estrecha® ø3.5	Universal ø4.1	Ancha ø5.5
			20 Ncm	25 Ncm	20 Ncm
Screwdriver	Coating	Seat			
1.20 Hex	-	Flat	IPD/GA-TN-00	-	IPD/GA-TW-00
1.20 Hex	TiN	Flat	IPD/GA-TN-00/TiN	-	IPD/GA-TW-00/TiN
1.20 Hex	BLC	Flat	IPD/GA-TN-00/BLC	-	IPD/GA-TW-00/BLC
1.20 Hex	-	Conical	-	IPD/BA-TR-00	-
1.20 Hex	TiN	Conical	-	IPD/BA-TR-00/TiN	-
1.20 Hex	BLC	Conical	-	IPD/BA-TR-00/BLC	-
	For ASC options	Torque value	25 Ncm	25 Ncm	
Screwdriver	Coating	Seat			
TPA	TiN	Flat	IPD/GA-TN-50	-	IPD/AA-TR-52
TPA	TiN	Conical	-	IPD/AA-TR-50	-
	Additional options	Torque value		25 Ncm	25Ncm
Screwdriver	Coating	Seat			
TPA	TiN	For implant level flat seat	-	IPD/AA-TR-52	IPD/AA-TR-52



MULTI-UNIT ABUTMENT

Angulation	Indication	Gingival Height (mm)	Estrecha® ø3.5	Universal ø4.1	Ancha ø5.5
0°	Single crown	1.0	-	IPD/AB-MR-01	-
		2.0	-	IPD/AB-MR-02	-
		3.0	-	IPD/AB-MR-03	-
		4.0	-	IPD/AB-MR-04	-
		5.0	-	IPD/AB-MR-05	-
17°	Full arch	2.0	-	IPD/AB-MR-12	-
		3.0	-	IPD/AB-MR-13	-
		4.0	-	IPD/AB-MR-14	-
		3.0	-	IPD/AB-MR-33	-
30°	Full arch	4.0	-	IPD/AB-MR-34	-
		5.0	-	IPD/AB-MR-35	-
		Replacement Screw for Angled MUA		-	IPD/KA-MT-00

Straight Multi-unit abutments can be used for single and multiple restorations. Please see page 206 for the Multi-unit system accessories.



ANALOGS



Type	Estrecha® ø3.5	Universal ø4.1	Ancha ø5.5
Standard	IPD/GA-AN-00	IPD/AA-AR-00	IPD/GA-AW-00
	Full set	IPD/GA-AN-90/3D	IPD/AA-AR-90/3D
Digital	Analogue		
	Bottom Screw		
	Side Screw		





RETURN TO INDEX

Co-Cr BASE ABUTMENT

Estrecha® ø3.5 ● Universal ø4.1 ● ● Ancha ø5.5 ●



Co-Cr Base for analogic workflow				
Indication	Angulation			
	0°	IPD/GA-BN-00	IPD/AA-BR-00	-
	15°	IPD/GA-BN-10	IPD/AA-BR-10	-
	25°	IPD/GA-BN-20	IPD/AA-BR-20	-
	0°	IPD/GA-BN-01	IPD/AA-BR-01	-
	15°	IPD/GA-BN-11	IPD/AA-BR-11	-
	25°	IPD/GA-BN-21	IPD/AA-BR-21	-

Co-Cr Base for digital workflow				
Indication	Angulation			
	Straight/ASC	IPD/GA-BN-00/3D	IPD/AA-BR-00/3D	-
	Straight/ASC	IPD/GA-BN-01/3D	IPD/AA-BR-01/3D	-
	Scan Body	IPD/SC-AN-B1	IPD/SC-AN-B1	-

All ASC CoCr analogic workflow abutments include the relevant TPA screw.



CASTABLE ABUTMENT

Indication		Estrecha® ø3.5 ●	Universal ø4.1 ● ●	Ancha ø5.5 ●
		-	IPD/AA-HR-00	IPD/GA-HW-00
		-	IPD/AA-RR-00	IPD/GA-RW-00

PSD OVERDENTURE ABUTMENT

Indication	Gingival Height (mm)	Estrecha® ø3.5 ●	Universal ø4.1 ● ●	Ancha ø5.5 ●
	1.0	IPD/GA-LN-01	IPD/AA-LR-01	-
	2.0	-	IPD/AA-LR-02	-
	3.0	IPD/GA-LN-03	IPD/AA-LR-03	-
	4.0	-	IPD/AA-LR-04	-
	5.0	IPD/GA-LN-05	IPD/AA-LR-05	-

Please see page 205 for the PSD system accessories.



COPING ABUTMENT

Type		Estrecha® ø3.5 ●	Universal ø4.1 ● ●	Ancha ø5.5 ●
Open tray		IPD/GA-CN-00	IPD/AA-CR-00	-
Closed tray		-	IPD/AA-CR-01	-

Classic Design



TEMPORARY ABUTMENT / OPEN TRAY COPING

Indication	Gingival Height (mm)	Estrecha® ø3.5 ●	Universal ø4.1 ● ●	Ancha ø5.5 ●
	1.5	IPD/GA-PN-06	IPD/AA-PR-06	-
	1.5	IPD/GA-PN-07	IPD/AA-PR-07	-
	Long coping screw	IPD/GA-TN-00/C	IPD/AA-TR-00/C	-

The same abutment can be used as a temporary abutment with the occlusal screw or as an impression coping using the coping screw.



HEALING ABUTMENT

Gingival Height (mm)	Head Diameter (mm)	Estrecha® ø3.5 ●	Universal ø4.1 ● ●	Ancha ø5.5 ●
2.0		-	IPD/AA-DR-02	-
3.0		-	IPD/AA-DR-03	-
4.0		IPD/GA-DN-04	IPD/AA-DR-04	-
5.0		-	IPD/AA-DR-05	-



TI CEMENT-RETAINED ABUTMENT

Indication	Angulation	Gingival Height	Estrecha® ø3.5 ●	Universal ø4.1 ● ●	Ancha ø5.5 ●
	0°	2.0	IPD/GA-PN-00	IPD/AA-PR-00	IPD/GA-PW-00
		2.0 Wide shoulder	-	-	IPD/GA-PW-01
	15°	1.0	-	IPD/AA-PR-02	-
		2.0	-	IPD/AA-PR-04	-
		1.0	-	IPD/AA-PR-03	-
	25°	1.0	-	IPD/AA-PR-05	-
2.0		-	IPD/AA-PR-01	-	

Using the Low profile IPD/AA-TR-01 screw for IPD/AA-PR-04 is recommended



SCREWDRIVERS

Type	Length (mm)	Estrecha® ø3.5 ●	Universal ø4.1 ● ●	Ancha ø5.5 ●
Implant system Screwdriver				
IPD Scan Body and extra Screwdrivers				
1.20 Hex	18	IPD/PH-20-18	IPD/PH-20-18	IPD/PH-20-18
	25	IPD/PH-20-25	IPD/PH-20-25	IPD/PH-20-25
	32	IPD/PH-20-32	IPD/PH-20-32	IPD/PH-20-32
ASC Screwdriver				
TPA	18	IPD/KA-CT-18	IPD/KA-CT-18	-
	25	IPD/KA-CT-25	IPD/KA-CT-25	-
	32	IPD/KA-CT-32	IPD/KA-CT-32	-
PSD Screwdriver				
PSD	25	IPD/LL-PS-00	IPD/LL-PS-00	-



ACCESSORIES

Indication	Length (mm)	Estrecha® ø3.5 ●	Universal ø4.1 ● ●	Ancha ø5.5 ●
Clinical RA Shank Handle	16	IPD/MC-00-16	IPD/MC-00-16	IPD/MC-00-16
Laboratory RA Shank Handle	70	IPD/ML-00-70	IPD/ML-00-70	IPD/ML-00-70
RA Shank Ratchet	90	IPD/DI-00-90	IPD/DI-00-90	IPD/DI-00-90
Ratchet adapter		IPD/DI-KA-90	IPD/DI-KA-90	IPD/DI-KA-90
PSD and insert extractor tool		IPD/LL-PS-01	IPD/LL-PS-01	-

Please see page 210 for more information.



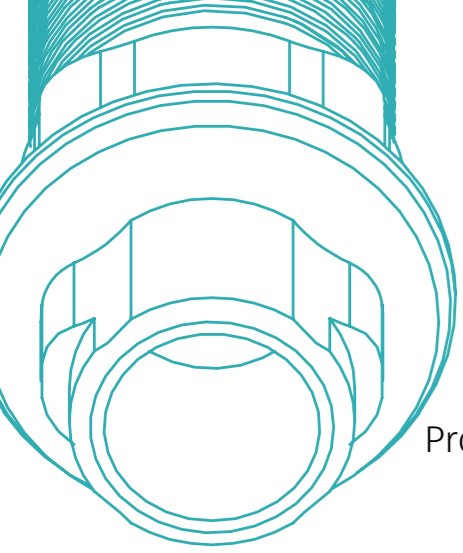

BTI® GB INTERNAL

Prosthetic platform [Estrecha ø3.5 / Universal ø4.1 / Ancha ø5.5]

SCAN BODY

	Indication	Height (mm)	Estrecha ø3.5	Universal ø4.1	Ancha ø5.5
Scan Body		10	IPD/GD-SN-00	IPD/GB-SR-00	-
		15	IPD/GD-SN-02	IPD/GB-SR-02	-
		10	IPD/GD-SN-01	IPD/GB-SR-01	-

Captive screw included. 1.20 Hex Screwdriver.

Ti-BASE Custom Ti-Base System®

Indication	Gingival Height (mm)	Estrecha ø3.5	Universal ø4.1	Ancha ø5.5
	0.5	IPD/GD-IN-00/3D	IPD/GB-IR-00/3D	-
	1.5	IPD/GD-IN-02/3D	IPD/GB-IR-02/3D	-
	2.5	IPD/GD-IN-04/3D	IPD/GB-IR-04/3D	-
	Cutting guide KIT	IPD/KT-IN-00	IPD/KT-IR-00	
	0.5	IPD/GD-IN-01/3D	IPD/GB-IR-01/3D	-
	1.5	IPD/GD-IN-03/3D	IPD/GB-IR-03/3D	-
	2.5	IPD/GD-IN-05/3D	IPD/GB-IR-05/3D	-
	Cutting guide KIT	IPD/KT-IN-01	IPD/KT-IR-01	

Please see page 204 for the IPD Custom Interface System accessories.

IPDMILLED SYSTEM*

*Check availability

Indication	Material	Diameter (mm)	Estrecha ø3.5	Universal ø4.1	Ancha ø5.5
TYPE A System (Compatible with DESS® Holders)	Ti	15	-	PR/GB-XR-15/A	-

All premilled abutments include 2 titanium screws.

SCREWS

			Estrecha ø3.5	Universal ø4.1	Ancha ø5.5
IPD and OEM compatible	For straight channels	Torque value	35 Ncm	35 Ncm	35 Ncm
Screwdriver	Coating	Seat			
1.20 Hex	-	Flat	IPD/GD-TN-00	IPD/GB-TR-00	IPD/GB-TR-00
1.20 Hex	TiN	Flat	IPD/GD-TN-00/TiN	IPD/GB-TR-00/TiN	IPD/GB-TR-00/TiN
1.20 Hex	BLC	Flat	IPD/GD-TN-00/BLC	IPD/GB-TR-00/BLC	IPD/GB-TR-00/BLC
	For ASC options	Torque value	25 Ncm	25 Ncm	25 Ncm
Screwdriver	Coating	Seat			
TPA	TiN	Flat	IPD/GB-TR-50	IPD/GB-TR-50	IPD/GB-TR-50



RETURN TO INDEX

MULTI-UNIT ABUTMENT

Angulation	Indication	Gingival Height (mm)	Estrecha ø3.5	Universal ø4.1	Ancha ø5.5
0°		1.0	IPD/GD-MN-01	IPD/GB-MR-01	-
		2.0	IPD/GD-MN-02	IPD/GB-MR-02	-
		3.0	IPD/GD-MN-03	IPD/GB-MR-03	-
		4.0	IPD/GD-MN-04	IPD/GB-MR-04	-
		5.0	-	IPD/GB-MR-05	-
17°		3.0	-	IPD/GB-MR-13	-
		4.0	-	IPD/GB-MR-14	-
30°		4.0	-	IPD/GB-MR-34	-
		5.0	-	IPD/GB-MR-35	-
		Replacement Screw for Angled MUA	-	IPD/KA-MT-07	-



Straight Multi-unit abutments can be used for single and multiple restorations. Please see page 206 for the Multi-unit system accessories.

MULTI-UNIT AP ABUTMENT*

*Check availability

Angulation		Gingival Height (mm)	Estrecha ø3.5	Universal ø4.1	Ancha ø5.5
17°		2.5	IPD/GD-MN-12/AP	IPD/GB-MR-12/AP	-
		3.5	IPD/GD-MN-13/AP	IPD/GB-MR-13/AP	-
30°		3.5	IPD/GD-MN-33/AP	IPD/GB-MR-33/AP	-
		4.5	IPD/GD-MN-34/AP	IPD/GB-MR-34/AP	-
		Replacement Screw for Angled MUA AP	IPD/KA-MT-07/BLC	IPD/KA-MT-07/BLC	-



Please see page 206 for the Multi-unit system accessories.

ANALOGS

Type		Estrecha ø3.5	Universal ø4.1	Ancha ø5.5
Standard		IPD/GD-AN-00	IPD/GB-AR-00	IPD/GB-AW-00
	Full set	IPD/GD-AN-90/3D	IPD/GB-AR-90/3D	-
Digital	Analog			
	Bottom Screw			
	Side Screw			



Co-Cr BASE ABUTMENT

			Estrecha ø3.5	Universal ø4.1	Ancha ø5.5
Co-Cr Base for analogic workflow					
Indication	Angulation				
	0°	-		IPD/GB-BR-00	-
	15°	-		IPD/GB-BR-10	-
	25°	-		IPD/GB-BR-20	-
	0°	-		IPD/GB-BR-01	-
	15°	-		IPD/GB-BR-11	-
	25°	-		IPD/GB-BR-21	-
Co-Cr Base for digital workflow					
Indication	Angulation				
	Straight/ASC	-		IPD/GB-BR-00/3D	-
		-		IPD/GB-BR-01/3D	-
	Straight/ASC	-		IPD/GB-BR-01/3D	-
		-		IPD/GB-BR-01/3D	-
	Scan Body	-		IPD/SC-AN-B1	-



All ASC CoCr analogic workflow abutments include the relevant TPA screw.

CASTABLE ABUTMENT

Indication	Estrecha ø3.5	Universal ø4.1	Ancha ø5.5
	-	IPD/GB-HR-00	-
	-	IPD/GB-RR-00	IPD/GB-RW-00





PSD OVERDENTURE ABUTMENT

Indication	Gingival Height (mm)	Estrecha ø3.5	Universal ø4.1	Ancha ø5.5
	1.0	-	IPD/GB-LR-01	-
	2.0	IPD/GD-LN-02	-	-
	3.0	IPD/GD-LN-03	IPD/GB-LR-03	-
	4.0	IPD/GD-LN-04	-	-
	5.0	-	IPD/GB-LR-05	-

Please see page 205 for the PSD system accessories.



TEMPORARY ABUTMENT / OPEN TRAY COPING

Indication	Gingival Height (mm)	Estrecha ø3.5	Universal ø4.1	Ancha ø5.5
	1.5	IPD/GD-PN-06	IPD/GB-PR-06	-
	1.5	IPD/GD-PN-07	IPD/GB-PR-07	-
Long coping screw		IPD/GD-TN-00/C	IPD/GB-TR-00/C	-

The same abutment can be used as a temporary abutment with the occlusal screw or as an impression coping using the coping screw.



HEALING ABUTMENT

Gingival Height (mm)	Head Diameter (mm)	Estrecha ø3.5	Universal ø4.1	Ancha ø5.5
1.0	ø4.0	IPD/GD-DN-01	IPD/GB-DR-01	-
2.0	ø4.0	IPD/GD-DN-02	-	-
3.0	ø4.0	IPD/GD-DN-03	IPD/GB-DR-03	-
5.0	ø4.1	-	IPD/GB-DR-05	-



SCREWDRIVERS

Type	Length (mm)	Estrecha ø3.5	Universal ø4.1	Ancha ø5.5
Implant system Screwdriver				
IPD Scan Body and extra Screwdrivers				
1.20 Hex	18	IPD/PH-20-18	IPD/PH-20-18	IPD/PH-20-18
	25	IPD/PH-20-25	IPD/PH-20-25	IPD/PH-20-25
	32	IPD/PH-20-32	IPD/PH-20-32	IPD/PH-20-32
ASC Screwdriver				
TPA	18	IPD/KA-CT-18	IPD/KA-CT-18	IPD/KA-CT-18
	25	IPD/KA-CT-25	IPD/KA-CT-25	IPD/KA-CT-25
	32	IPD/KA-CT-32	IPD/KA-CT-32	IPD/KA-CT-32
PSD Screwdriver				
PSD	25	IPD/LL-PS-00	IPD/LL-PS-00	-



ACCESSORIES

Indication	Length (mm)	Estrecha ø3.5	Universal ø4.1	Ancha ø5.5
Clinical RA Shank Handle	16	IPD/MC-00-16	IPD/MC-00-16	IPD/MC-00-16
Laboratory RA Shank Handle	70	IPD/ML-00-70	IPD/ML-00-70	IPD/ML-00-70
RA Shank Ratchet	90	IPD/DI-00-90	IPD/DI-00-90	IPD/DI-00-90
Ratchet adapter		IPD/DI-KA-90	IPD/DI-KA-90	IPD/DI-KA-90
PSD and insert extractor tool		IPD/LL-PS-01	IPD/LL-PS-01	-

Please see page 210 for more information.



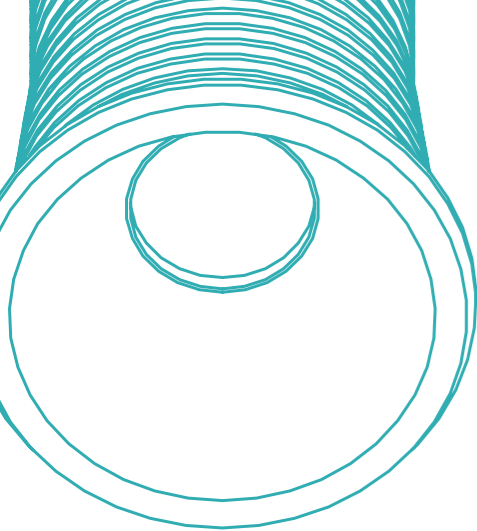

BTI®

GC MULTI-IM®

Prosthetic platform [Ø4.1]

SCAN BODY / SCAN DATA MARKER

Indication	Height (mm)	Ø4.1
Scan Body 	10	IPD/GC-SR-01

Captive screw included except on Reverse Scan Data Marker. 1.20 Hex Screwdriver



Ti-BASE

Indication	Post height (mm)	Gingival Height (mm)	Ø4.1
	3.5	0.3	IPD/GC-IR-01/3D



SCREWS

IPD and OEM compatible			Ø4.1
Screwdriver	Coating	Seat	
1.20 Hex	-	Flat	IPD/GC-TR-01
1.20 Hex	TiN	Flat	IPD/GC-TR-01/TiN
1.20 Hex	BLC	Flat	IPD/GC-TR-01/BLC

For ASC options			Torque value
Screwdriver	Coating	Seat	15 Ncm
TPA	TiN	Flat	IPD/AB-TR-50



ANALOGS

Type	Ø4.1
Standard	IPD/GC-AR-00
	Full set IPD/GC-AR-90/3D
Digital	Analog Bottom Screw Side Screw



[RETURN TO INDEX](#)

Co-Cr BASE ABUTMENT

Co-Cr Base for analogic workflow		Ø4.1
Indication	Angulation	
	0°	IPD/GC-BR-01
	15°	IPD/GC-BR-11
	25°	IPD/GC-BR-21

Co-Cr Base for digital workflow		Scan Body
Indication	Angulation	
	Straight/ASC	IPD/GC-BR-01/3D
		IPD/SC-AN-B2

All ASC CoCr analogic workflow abutments include the relevant TPA screw.



TEMPORARY ABUTMENT / OPEN TRAY COPING

Indication	Gingival Height (mm)	Ø4.1
	1.5	IPD/GC-PR-07
		Long coping screw IPD/GC-TR-01/C

The same abutment can be used as a temporary abutment with the occlusal screw or as an impression coping using the coping screw.



HEALING ABUTMENT

Gingival Height (mm)	Head Diameter (mm)	Ø4.1
4.0	Ø4.1	IPD/GC-DR-04

One piece healing abutment, no need to order screw.



SCREWDRIVERS

Type	Length (mm)	Ø4.1
Implant system Screwdriver		
IPD Scan Body and extra Screwdrivers		
1.20 Hex	18	IPD/PH-20-18
	25	IPD/PH-20-25
	32	IPD/PH-20-32
ASC Screwdriver		
TPA	18	IPD/KA-CT-18
	25	IPD/KA-CT-25
	32	IPD/KA-CT-32



ACCESSORIES

Indication	Length (mm)	Ø4.1
Clinical RA Shank Handle	16	IPD/MC-00-16
Laboratory RA Shank Handle	70	IPD/ML-00-70
RA Shank Ratchet	90	IPD/DI-00-90
Ratchet adapter		IPD/DI-KA-90

Please see page 210 for more information.



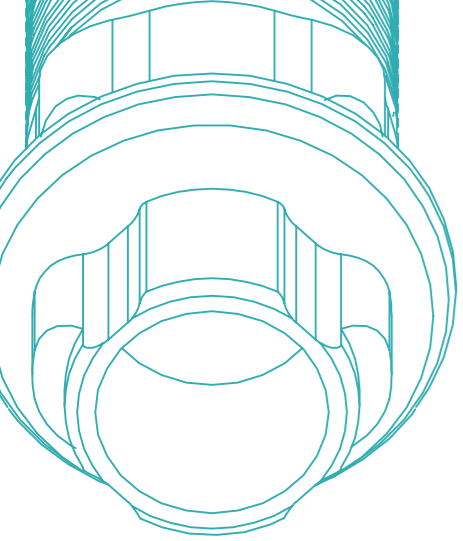

BTI® GD CORE®

Prosthetic platform [CORE ø3.5]

*Not compatible with 4.5mm implant length

SCAN BODY

Indication	Height (mm)	CORE ø3.5
	10	IPD/GD-SN-00
Scan Body	15	IPD/GD-SN-02
	10	IPD/GD-SN-01

Captive screw included. 1.20 Hex Screwdriver.

Ti-BASE ipd Custom Ti-Base System®

Indication	Gingival Height (mm)	CORE ø3.5
Single	0.5	IPD/GD-IN-00/3D
	1.5	IPD/GD-IN-02/3D
	2.5	IPD/GD-IN-04/3D
	Cutting guide KIT	IPD/KT-IN-00
Multiple	0.5	IPD/GD-IN-01/3D
	1.5	IPD/GD-IN-03/3D
	2.5	IPD/GD-IN-05/3D
	Cutting guide KIT	IPD/KT-IN-01

Please see page 204 for the IPD Custom Interface System accessories.

SCREWS

IPD and OEM compatible			Torque value	CORE ø3.5
	For straight channels		35 Ncm	
Screwdriver	Coating	Seat		
1.20 Hex	-	Flat		IPD/GD-TN-00
1.20 Hex	TiN	Flat		IPD/GD-TN-00/TiN
1.20 Hex	BLC	Flat		IPD/GD-TN-00/BLC
For ASC options			Torque value	CORE ø3.5
			25 Ncm	
Screwdriver	Coating	Seat		
TPA	TiN	Flat		IPD/GB-TR-50

MULTI-UNIT ABUTMENT

Angulation	Indication	Gingival Height (mm)	CORE ø3.5
0°	Single	1.0	IPD/GD-MN-01
		2.0	IPD/GD-MN-02
	Multiple	3.0	IPD/GD-MN-03
		4.0	IPD/GD-MN-04

Straight Multi-unit abutments can be used for single and multiple restorations. Please see page 206 for the Multi-unit system accessories.



[RETURN TO INDEX](#)

MULTI-UNIT AP ABUTMENT* NEW

*Check availability

Angulation	Indication	Gingival Height (mm)	CORE ø3.5
17°	Single	2.5	IPD/GD-MN-12/AP
		3.5	IPD/GD-MN-13/AP
30°	Multiple	3.5	IPD/GD-MN-33/AP
		4.5	IPD/GD-MN-34/AP
		Replacement Screw for Angled MUA AP	IPD/KA-MT-07/BLC

Please see page 206 for the Multi-unit system accessories.



ANALOGS

Type	CORE ø3.5	
Standard	IPD/GD-AN-00	
	Full set	IPD/GD-AN-90/3D
Digital	Analog	
	Bottom Screw	
	Side Screw	



PSD OVERDENTURE ABUTMENT

Indication	Gingival Height (mm)	CORE ø3.5
Multiple	2.0	IPD/GD-LN-02
	3.0	IPD/GD-LN-03
	4.0	IPD/GD-LN-04

Please see page 205 for the PSD system accessories.



TEMPORARY ABUTMENT / OPEN TRAY COPING

Indication	Gingival Height (mm)	CORE ø3.5	
Single	1.5	IPD/GD-PN-06	
Multiple	1.5	IPD/GD-PN-07	
		Long coping screw	IPD/GD-TN-00/C

The same abutment can be used as a temporary abutment with the occlusal screw or as an impression coping using the coping screw.



HEALING ABUTMENT

Gingival Height (mm)	Head Diameter (mm)	CORE ø3.5
	ø4.0	
1.0		IPD/GD-DN-01
2.0		IPD/GD-DN-02
3.0		IPD/GD-DN-03



SCREWDRIVERS

Type	Length (mm)	CORE ϕ 3.5
Implant system Screwdriver		
IPD Data markers and extras Screwdriver		
1.20 Hex	18	IPD/PH-20-18
	25	IPD/PH-20-25
	32	IPD/PH-20-32
ASC Screwdriver		
TPA	18	IPD/KA-CT-18
	25	IPD/KA-CT-25
	32	IPD/KA-CT-32
PSD Screwdriver		
PSD	25	IPD/LL-PS-00



ACCESSORIES

Indication	Length (mm)	CORE ϕ 3.5
Clinical RA Shank Handle	16	IPD/MC-00-16
Laboratory RA Shank Handle	70	IPD/ML-00-70
RA Shank Ratchet	90	IPD/DI-00-90
Ratchet adapter		IPD/DI-KA-90
PSD and insert extractor		IPD/LL-PS-01

Please see page 210 for more information.



MICRODENT®

HA MICRODENT® SYSTEM

Prosthetic platform [ϕ 3.5 / ϕ 4.2 / ϕ 5.1]

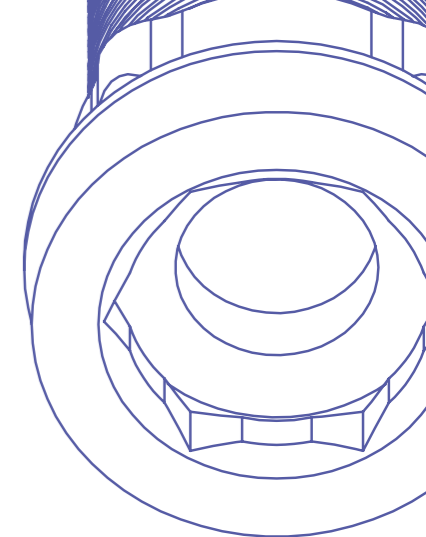

SCAN BODY

	Indication	Height (mm)	ϕ 3.5	ϕ 4.2	ϕ 5.1
Scan Body		10	-	-	IPD/NA-SW-00
		10	-	-	IPD/NA-SW-01

Captive screw included. 1.20 Hex Screwdriver.



Ti-BASE *ipd* Custom Ti-Base System®

Indication	Gingival Height (mm)	ϕ 3.5	ϕ 4.2	ϕ 5.1
	1.3	-	-	IPD/NA-IW-02/3D
		Cutting guide KIT		
	1.3	-	-	IPD/NA-IW-03/3D
		Cutting guide KIT		
		-	-	IPD/KT-IW-01

Please see page 204 for the IPD Custom Interface System accessories.

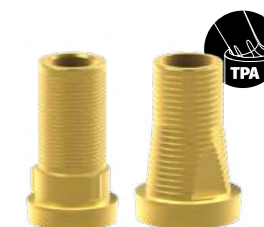

SCREWS

			ϕ 3.5	ϕ 4.2	ϕ 5.1
IPD and OEM compatible	For straight channels	Torque value	20 Ncm	30 Ncm	30 Ncm
Screwdriver	Coating	Seat			
1.20 Hex	-	Conical	IPD/HA-TN-00	-	-
1.20 Hex	TiN	Conical	IPD/HA-TN-00/TiN	-	-
1.20 Hex	BLC	Conical	IPD/HA-TN-00/BLC	-	-
1.75 Hex	-	Conical	-	IPD/HA-TR-00	IPD/HA-TR-00
1.75 Hex	TiN	Conical	-	IPD/HA-TR-00/TiN	IPD/HA-TR-00/TiN
1.75 Hex	BLC	Conical	-	IPD/HA-TR-00/BLC	IPD/HA-TR-00/BLC
			Torque value	25 Ncm	25 Ncm
Screwdriver	Coating	Seat			
TPA	TiN	Conical	IPD/HA-TN-50	IPD/HA-TR-50	IPD/HA-TR-50
			Torque value		35 Ncm
IPD Custom Ti-base compatible	For straight channels	Torque value			
Screwdriver	Coating	Seat			
1.25 Hex	-	Conical	-	-	IPD/NA-TW-00
			Torque value		25 Ncm
Screwdriver	Coating	Seat			
TPA	TiN	Conical	-	-	IPD/MB-TR-50



RETURN TO INDEX

ANALOGS

Type		ø3.5	ø4.2	ø5.1
Standard		IPD/HA-AN-00	IPD/HA-AR-00	IPD/HA-AW-00
	Full set	-	-	IPD/NA-AW-90/3D
Digital	Analog			
	Bottom Screw			
	Side Screw			



CASTABLE ABUTMENT

Indication		ø3.5	ø4.2	ø5.1
		IPD/HA-HN-00	IPD/HA-HR-00	IPD/HA-HW-00
		IPD/HA-RN-00	IPD/HA-RR-00	IPD/HA-RW-00



TEMPORARY ABUTMENT / OPEN TRAY COPING

Indication	Gingival Height (mm)	ø3.5	ø4.2	ø5.1
	1.5	-	-	IPD/NA-PW-06
	1.5	-	-	IPD/NA-PW-07
	Long coping screw	-	-	IPD/NA-TW-00/C



The same abutment can be used as a temporary abutment with the occlusal screw or as an impression coping using the coping screw.

HEALING ABUTMENT

Gingival Height (mm)		ø3.5	ø4.2	ø5.1
	Head Diameter (mm)			ø 5.5
3.0		-	-	IPD/NA-DW-03
5.0		-	-	IPD/NA-DW-05



SCREWDRIVERS

Type	Length (mm)	ø3.5	ø4.2	ø5.1
Implant system Screwdriver				
IPD Scan Body and extra Screwdrivers				
1.20 Hex	18	IPD/PH-20-18	IPD/PH-20-18	IPD/PH-20-18
	25	IPD/PH-20-25	IPD/PH-20-25	IPD/PH-20-25
	32	IPD/PH-20-32	IPD/PH-20-32	IPD/PH-20-32
Extra optional Screwdrivers				
1.25 Hex	18	IPD/PH-25-18	IPD/PH-25-18	IPD/PH-25-18
	25	IPD/PH-25-25	IPD/PH-25-25	IPD/PH-25-25
	32	IPD/PH-25-32	IPD/PH-25-32	IPD/PH-25-32
ASC Screwdriver				
TPA	18	IPD/KA-CT-18	IPD/KA-CT-18	IPD/KA-CT-18
	25	IPD/KA-CT-25	IPD/KA-CT-25	IPD/KA-CT-25
	32	IPD/KA-CT-32	IPD/KA-CT-32	IPD/KA-CT-32



ACCESSORIES

Indication	Length (mm)	ø3.5	ø4.2	ø5.1
Clinical RA Shank Handle	16	IPD/MC-00-16	IPD/MC-00-16	IPD/MC-00-16
Laboratory RA Shank Handle	70	IPD/ML-00-70	IPD/ML-00-70	IPD/ML-00-70
RA Shank Ratchet	90	IPD/DI-00-90	IPD/DI-00-90	IPD/DI-00-90
Ratchet adapter		IPD/DI-KA-90	IPD/DI-KA-90	IPD/DI-KA-90
PSD and insert extractor tool		-	-	IPD/LL-PS-01



Please see page 210 for more information.

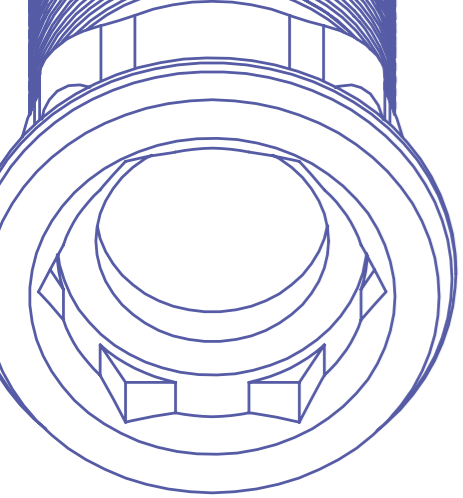

MICRODENT®

HB MICRODENT® UNIVERSAL™

Prosthetic platform [ø4.1 / ø5.1]

SCAN BODY

	Indication	Height (mm)	ø4.1	ø5.1
Scan Body		10	IPD/AA-SR-00	IPD/BA-SW-00
		15	IPD/AA-SR-02	IPD/BA-SW-02
		10	IPD/AA-SR-01	IPD/BA-SW-01

Captive screw included. 1.20 Hex Screwdriver.



Ti-BASE Custom Ti-Base System®

Indication	Gingival Height (mm)	ø4.1	ø5.1
	0.5	IPD/AA-IR-00/3D	IPD/BA-IW-00/3D
	1.5	IPD/AA-IR-02/3D	IPD/BA-IW-02/3D
	2.5	IPD/AA-IR-04/3D	-
	Cutting guide KIT		IPD/KT-IR-00
	0.5	IPD/AA-IR-01/3D	IPD/BA-IW-01/3D
	1.5	IPD/AA-IR-03/3D	IPD/BA-IW-03/3D
	2.5	IPD/AA-IR-05/3D	-
	Cutting guide KIT		IPD/KT-IR-01

Please see page 204 for the IPD Custom Interface System accessories.



IPDMILLED SYSTEM*

*Check availability

Indication	Material	Diameter (mm)	ø4.1	ø5.1
TYPE A System (Compatible with DESS® Holders)				
	Ti	15	PR/AA-XR-15/A	PR/BA-XW-15/A

All premilled abutments include 2 titanium screws.



SCREWS

IPD and OEM compatible	For straight channels	Torque value	ø4.1	ø5.1
			25 Ncm	25 Ncm
Screwdriver	Coating	Seat		
1.20 Hex	-	Conical	IPD/BA-TR-00	IPD/BA-TR-00
1.20 Hex	TiN	Conical	IPD/BA-TR-00/TiN	IPD/BA-TR-00/TiN
1.20 Hex	BLC	Conical	IPD/BA-TR-00/BLC	IPD/BA-TR-00/BLC

	For ASC options	Torque value	ø4.1	ø5.1
			25 Ncm	25 Ncm
Screwdriver	Coating	Seat		
TPA	TiN	Conical	IPD/AA-TR-50	IPD/AA-TR-50

Additional options	For straight channels	Torque value	ø4.1	ø5.1
			20 Ncm	20 Ncm
Screwdriver	Coating	Seat		
1.20 Hex	-	Low profile head - conical seat	IPD/AA-TR-01	IPD/AA-TR-01
1.20 Hex	TiN	Low profile head - conical seat	IPD/AA-TR-01/TiN	IPD/AA-TR-01/TiN
1.20 Hex	BLC	Low profile head - conical seat	IPD/AA-TR-01/BLC	IPD/AA-TR-01/BLC

	For ASC options	Torque value	ø4.1	ø5.1
			25 Ncm	25 Ncm
Screwdriver	Coating	Seat		
TPA	TiN	For implant level flat seat	IPD/AA-TR-52	IPD/AA-TR-52

Removing tool



MULTI-UNIT ABUTMENT

Angulation	Indication	Gingival Height (mm)	ø4.1	ø5.1
0°		1.0	IPD/AB-MR-01	-
		2.0	IPD/AB-MR-02	-
		3.0	IPD/AB-MR-03	-
		4.0	IPD/AB-MR-04	-
		5.0	IPD/AB-MR-05	-
17°		2.0	IPD/AB-MR-12	-
		3.0	IPD/AB-MR-13	-
		4.0	IPD/AB-MR-14	-
		3.0	IPD/AB-MR-33	-
30°		4.0	IPD/AB-MR-34	-
		5.0	IPD/AB-MR-35	-
		Replacement Screw for Angled MUA		IPD/KA-MT-00



ANALOGS

Type		ø4.1	ø5.1
Standard		IPD/AA-AR-00	IPD/BA-AW-00
	Full set	IPD/AA-AR-90/3D	IPD/BA-AW-90/3D
Digital	Analog Bottom Screw Side Screw		



RETURN TO INDEX

Co-Cr BASE ABUTMENT

		ø4.1	ø5.1
Co-Cr Base for analogic workflow			
Indication	Angulation		
	0°	IPD/AA-BR-00	IPD/BA-BW-00
	15°	IPD/AA-BR-10	IPD/BA-BW-10
	25°	IPD/AA-BR-20	IPD/BA-BW-20
	0°	IPD/AA-BR-01	IPD/BA-BW-01
	15°	IPD/AA-BR-11	IPD/BA-BW-11
	25°	IPD/AA-BR-21	IPD/BA-BW-21
Co-Cr Base for digital workflow			
Indication	Angulation		
	Straight/ASC	IPD/AA-BR-00/3D	IPD/BA-BW-00/3D
	Straight/ASC	IPD/AA-BR-01/3D	IPD/BA-BW-01/3D
	Scan Body	IPD/SC-AN-B1	IPD/SC-AN-B1

All ASC CoCr analogic workflow abutments include the relevant TPA screw.



CASTABLE ABUTMENT

Indication	ø4.1	ø5.1
	IPD/AA-HR-00	IPD/BA-HW-00
	IPD/AA-RR-00	IPD/BA-RW-00



PSD OVERDENTURE ABUTMENT

Indication	Gingival Height (mm)	ø4.1	ø5.1
	1.0	IPD/AA-LR-01	-
	2.0	IPD/AA-LR-02	-
	3.0	IPD/AA-LR-03	-
	4.0	IPD/AA-LR-04	-
	5.0	IPD/AA-LR-05	-

Please see page 205 for the PSD system accessories.



COPING ABUTMENT

Type	ø4.1	ø5.1
Open tray	IPD/AA-CR-00	IPD/BA-CW-00
Closed tray	IPD/AA-CR-01	-
Classic Design		



TEMPORARY ABUTMENT / OPEN TRAY COPING

Indication	Gingival Height (mm)	ø4.1	ø5.1
	1.5	IPD/AA-PR-06	IPD/BA-PW-06
	1.5	IPD/AA-PR-07	IPD/BA-PW-07
	Long coping screw	IPD/AA-TR-00/C	IPD/AA-TR-00/C

The same abutment can be used as a temporary abutment with the occlusal screw or as an impression coping using the coping screw.



HEALING ABUTMENT

Gingival Height (mm)	Head Diameter (mm)	ø4.1	ø5.1
2.0		IPD/AA-DR-02	IPD/BA-DW-02
3.0		IPD/AA-DR-03	IPD/BA-DW-03
4.0		IPD/AA-DR-04	IPD/BA-DW-04
5.0		IPD/AA-DR-05	-



TI CEMENT-RETAINED ABUTMENT

Indication	Angulation	Gingival Height	ø4.1	ø5.1
	0°	2.0	IPD/AA-PR-00	-
	15°	1.0	IPD/AA-PR-02	-
		2.0	IPD/AA-PR-04	-
	25°	1.0	IPD/AA-PR-03	-
		2.0	IPD/AA-PR-05	-
	0°	2.0	IPD/AA-PR-01	-

Using the Low profile IPD/AA-TR-01 screw for IPD/AA-PR-04 is recommended



SCREWDRIVERS

Type	Length (mm)	ø4.1	ø5.1
Implant system Screwdriver			
IPD Scan Body and extra Screwdrivers			
1.20 Hex	18	IPD/PH-20-18	IPD/PH-20-18
	25	IPD/PH-20-25	IPD/PH-20-25
	32	IPD/PH-20-32	IPD/PH-20-32
ASC Screwdriver			
TPA	18	IPD/KA-CT-18	IPD/KA-CT-18
	25	IPD/KA-CT-25	IPD/KA-CT-25
	32	IPD/KA-CT-32	IPD/KA-CT-32
PSD Screwdriver			
PSD	25	IPD/LL-PS-00	-



ACCESSORIES

Indication	Length (mm)	ø4.1	ø5.1
Clinical RA Shank Handle	16	IPD/MC-00-16	IPD/MC-00-16
Laboratory RA Shank Handle	70	IPD/ML-00-70	IPD/ML-00-70
RA Shank Ratchet	90	IPD/DI-00-90	IPD/DI-00-90
Ratchet adapter		IPD/DI-KA-90	IPD/DI-KA-90
PSD and insert extractor tool		IPD/LL-PS-01	-

Please see page 210 for more information.



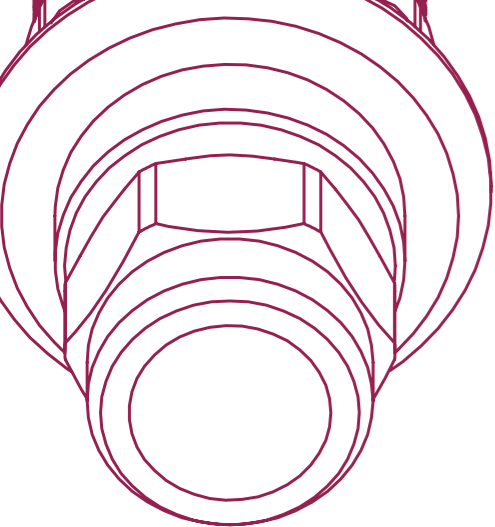

DENTSPLY®

IA XIVE® FRIADENT®

Prosthetic platform [ø3.4 / ø3.8 / ø4.5 / ø5.5]

SCAN BODY*

*Check availability

Indication	Height (mm)	ø3.4	ø3.8	ø4.5	ø5.5
Scan Body	10	IPD/IA-SN-00	IPD/IA-SR-00	IPD/IA-SW-00	IPD/IA-SW-00
	15	IPD/IA-SN-02	IPD/IA-SR-02	-	-
	10	IPD/IA-SN-01	IPD/IA-SR-01	-	-

Captive screw included. 1.20 Hex Screwdriver.



Ti-BASE Custom Ti-Base System®

Indication	Gingival Height (mm)	ø3.4	ø3.8	ø4.5	ø5.5
Scan Body	0.5	-	IPD/IA-IR-00/3D	-	-
	1.5	IPD/IA-IN-02/3D	IPD/IA-IR-02/3D	-	-
	Cutting guide KIT		IPD/KT-IN-00	IPD/KT-IR-00	-
Scan Body	0.5	-	IPD/IA-IR-01/3D	-	-
	1.5	IPD/IA-IN-03/3D	IPD/IA-IR-03/3D	-	-
	Cutting guide KIT		IPD/KT-IN-01	IPD/KT-IR-01	-

Please see page 204 for the IPD Custom Interface System accessories.



IPDMILLED SYSTEM*

*Check availability

Indication	Material	Diameter (mm)	ø3.4	ø3.8	ø4.5	ø5.5
IPD Blank System (Compatible with NT/IPD Holders)						
	Ti	12	-	IPD/IA-XR-00	IPD/IA-XW-00	IPD/IA-XX-00
Mill Analog	-	-	-	IPD/IA-AR-00/X	IPD/IA-AW-00/X	IPD/IA-AX-00/X
TYPE A System (Compatible with DESS® Holders)						
	Ti	15	PR/IA-XN-15/A	PR/IA-XR-15/A	PR/IA-XW-15/A	-

All premilled abutments include 2 titanium screws.



SCREWS

			ø3.4	ø3.8	ø4.5	ø5.5
IPD and OEM compatible	For straight channels	Torque value	24 Ncm	24 Ncm	24 Ncm	24 Ncm
Screwdriver	Coating	Seat				
1.20 Hex	-	Conical	IPD/IA-TR-00	IPD/IA-TR-00	IPD/IA-TR-00	IPD/IA-TR-00
1.20 Hex	TiN	Conical	IPD/IA-TR-00/TiN	IPD/IA-TR-00/TiN	IPD/IA-TR-00/TiN	IPD/IA-TR-00/TiN
1.20 Hex	BLC	Conical	IPD/IA-TR-00/BLC	IPD/IA-TR-00/BLC	IPD/IA-TR-00/BLC	IPD/IA-TR-00/BLC

			20 Ncm	20 Ncm	20 Ncm	20 Ncm
IPDmilled compatible	For ASC options	Torque value	20 Ncm	20 Ncm	20 Ncm	20 Ncm
Screwdriver	Coating	Seat				
TPA	TiN	Conical	IPD/IA-TR-50	IPD/IA-TR-50	IPD/IA-TR-50	IPD/IA-TR-50

			24 Ncm	24 Ncm	24 Ncm	24 Ncm
IPDmilled compatible		Torque value	24 Ncm	24 Ncm	24 Ncm	24 Ncm
Screwdriver	Coating	Seat				
1.20 Hex	-	Conical	IPD/IA-TR-00/X	IPD/IA-TR-00/X	IPD/IA-TR-00/X	IPD/IA-TR-00/X



ANALOGS

Type	ø3.4	ø3.8	ø4.5	ø5.5
Standard	IPD/IA-AN-00	IPD/IA-AR-00	IPD/IA-AW-00	-
	Full set	IPD/IA-AN-90/3D	IPD/IA-AR-90/3D	-
Digital	Analog Bottom Screw Side Screw			



Co-Cr BASE ABUTMENT

		ø3.4	ø3.8	ø4.5	ø5.5
Co-Cr Base for analogic workflow					
Indication	Angulation				
Scan Body	0°	IPD/IA-BN-00	IPD/IA-BR-00	-	-
	15°	-	IPD/IA-BR-10	-	-
	25°	-	IPD/IA-BR-20	-	-
Scan Body	0°	IPD/IA-BN-01	IPD/IA-BR-01	-	-
	15°	-	IPD/IA-BR-11	-	-
	25°	-	IPD/IA-BR-21	-	-



		ø3.4	ø3.8	ø4.5	ø5.5
Co-Cr Base for digital workflow					
Indication	Angulation				
Scan Body	Straight/ASC	IPD/IA-BN-00/3D	IPD/IA-BR-00/3D	-	-
	Straight/ASC	IPD/IA-BN-01/3D	IPD/IA-BR-01/3D	-	-
Scan Body		IPD/SC-AN-B1	IPD/SC-AN-B1	-	-



All ASC CoCr analogic workflow abutments include the relevant TPA screw.

CASTABLE ABUTMENT

Indication	ø3.4	ø3.8	ø4.5	ø5.5
Scan Body	-	IPD/IA-HR-00	IPD/IA-HW-00	-
Scan Body	-	IPD/IA-RR-00	IPD/IA-RW-00	-



RETURN TO INDEX

TEMPORARY ABUTMENT / OPEN TRAY COPING

Indication	Gingival Height (mm)	ø3.4	ø3.8	ø4.5	ø5.5
	1.5	IPD/IA-PN-06	IPD/IA-PR-06	IPD/IA-PW-06	-
	1.5	IPD/IA-PN-07	IPD/IA-PR-07	IPD/IA-PW-07	-
Long coping screw		IPD/IA-TR-00/C	IPD/IA-TR-00/C	IPD/IA-TR-00/C	-

The same abutment can be used as a temporary abutment with the occlusal screw or as an impression coping using the coping screw.

HEALING ABUTMENT

Gingival Height (mm)	Head Diameter (mm)	ø3.4	ø3.8	ø4.5	ø5.5
2.0		IPD/IA-DN-02	IPD/IA-DR-02	IPD/IA-DW-02	-
3.5		IPD/IA-DN-03	IPD/IA-DR-03	IPD/IA-DW-03	-
5.0		IPD/IA-DN-05	IPD/IA-DR-05	IPD/IA-DW-05	-

SCREWDRIVERS

Type	Length (mm)	ø3.4	ø3.8	ø4.5	ø5.5
Implant system Screwdriver					
IPD Scan Body and extra Screwdrivers					
	18	IPD/PH-20-18	IPD/PH-20-18	IPD/PH-20-18	IPD/PH-20-18
1.20 Hex	25	IPD/PH-20-25	IPD/PH-20-25	IPD/PH-20-25	IPD/PH-20-25
	32	IPD/PH-20-32	IPD/PH-20-32	IPD/PH-20-32	IPD/PH-20-32
ASC Screwdriver					
TPA	18	IPD/KA-CT-18	IPD/KA-CT-18	IPD/KA-CT-18	IPD/KA-CT-18
	25	IPD/KA-CT-25	IPD/KA-CT-25	IPD/KA-CT-25	IPD/KA-CT-25
	32	IPD/KA-CT-32	IPD/KA-CT-32	IPD/KA-CT-32	IPD/KA-CT-32

ACCESSORIES

Indication	Length (mm)	ø3.4	ø3.8	ø4.5	ø5.5
Clinical RA Shank Handle	16	IPD/MC-00-16	IPD/MC-00-16	IPD/MC-00-16	IPD/MC-00-16
Laboratory RA Shank Handle	70	IPD/ML-00-70	IPD/ML-00-70	IPD/ML-00-70	IPD/ML-00-70
RA Shank Ratchet	90	IPD/DI-00-90	IPD/DI-00-90	IPD/DI-00-90	IPD/DI-00-90
Ratchet adapter		IPD/DI-KA-90	IPD/DI-KA-90	IPD/DI-KA-90	IPD/DI-KA-90

Please see page 210 for more information.



DENTSPLY®

IB ANKYLOS®

Prosthetic platform [Balance Base / C/X]

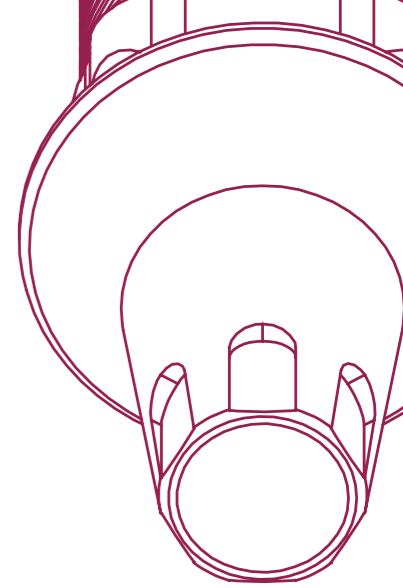

SCAN BODY

	Indication	Height (mm)	Balance Base	C/X
Scan Body		10	-	IPD/IB-SR-00
		15	-	IPD/IB-SR-02
		10	-	IPD/IB-SR-01

Captive screw included. 1.20 Hex Screwdriver.



Ti-BASE Custom Ti-Base System®

Indication	Gingival Height (mm)	Balance Base	C/X
	1.5	-	IPD/IB-IR-02/3D
	2.5	-	IPD/IB-IR-04/3D
Cutting guide KIT		-	IPD/KT-IR-00
	1.5	-	IPD/IB-IR-03/3D
	2.5	-	IPD/IB-IR-05/3D
Cutting guide KIT		-	IPD/KT-IR-01

Please see page 204 for the IPD Custom Interface System accessories.



IPDMILLED SYSTEM*

*Check availability

Indication	Material	Diameter (mm)	Balance Base	C/X
IPD Blank System (Compatible with NT/IPD Holders)				
	Ti	12	-	IPD/IB-XR-00
Mill Analog			-	IPD/IB-AR-00/X
TYPE A System (Compatible with DESS® Holders)				
	Ti	10	-	PR/IB-XR-10/A
	Ti	15	-	PR/IB-XR-15/A

All premilled abutments include 2 titanium screws.



SCREWS

			Balance Base	C/X
Non-Engaging IPD and OEM compatible		For straight channels	20Ncm	15Ncm
Screwdriver	Coating	Seat		
1.00 Hex	-	Conical	IPD/IB-TR-00	IPD/IB-TR-01
IPDmilled compatible		Torque value		15Ncm
Screwdriver	Coating	Seat		
1.00 Hex	-	Conical	-	IPD/IB-TR-01/X



[RETURN TO INDEX](#)

ANALOGS

Type	Balance Base	C/X
Standard	-	IPD/IB-AR-00
Full set	-	IPD/IB-AR-90/3D
Digital	Analog	
	Bottom Screw	
	Side Screw	

PSD OVERDENTURE ABUTMENT

Indication	Gingival Height (mm)	Balance Base	C/X
	1.5	-	IPD/IB-LR-01
	3.0	-	IPD/IB-LR-03
	5.0	-	IPD/IB-LR-05

Please see page 205 for the PSD system accessories.

COPING ABUTMENT

Type	Balance Base	C/X
Open tray	-	IPD/IB-CR-00

Classic Design

HEALING ABUTMENT

Gingival Height (mm)	Head Diameter (mm)	Balance Base	C/X
3.0	ø6.0	-	IPD/IB-DR-03

SCREWDRIVERS

Type	Length (mm)	Balance Base	C/X
Implant system Screwdriver			
	18	-	IPD/PH-00-18
1.00 Hex	25	-	IPD/PH-00-25
	32	-	IPD/PH-00-32
IPD Scan Body and extra Screwdrivers			
	18	-	IPD/PH-20-18
1.20 Hex	25	-	IPD/PH-20-25
	32	-	IPD/PH-20-32
ASC Screwdriver			
	18	-	IPD/KA-CT-18
TPA	25	-	IPD/KA-CT-25
	32	-	IPD/KA-CT-32
PSD Screwdriver			
PSD	25	-	IPD/LL-PS-00

ACCESSORIES

Indication	Length (mm)	Balance Base	C/X
Clinical RA Shank Handle	16	-	IPD/MC-00-16
Laboratory RA Shank Handle	70	-	IPD/ML-00-70
RA Shank Ratchet	90	-	IPD/DI-00-90
Ratchet adapter	-	-	IPD/DI-KA-90
PSD and insert extractor tool	-	-	IPD/LL-PS-01

Please see page 210 for more information.



CAMLOG®

JA CAMLOG® IMPLANT SYSTEM

Prosthetic platform [ø3.3 / ø3.8 / ø4.3 / ø5.0]

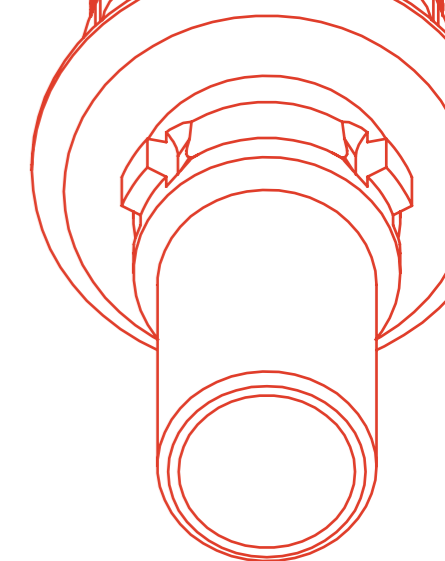

SCAN BODY

Indication	Height (mm)	ø3.3	ø3.8	ø4.3	ø5.0
	10	IPD/JA-SN-00	IPD/JA-SR-00	IPD/JA-SW-00	IPD/JA-SX-00
	15	IPD/JA-SN-02	IPD/JA-SR-02	IPD/JA-SW-02	IPD/JA-SX-02
	10	IPD/JA-SN-01	IPD/JA-SR-01	IPD/JA-SW-01	IPD/JA-SX-01

Captive screw included. 1.20 Hex Screwdriver.



Ti-BASE Custom Ti-Base System®

Indication	Gingival Height (mm)	ø3.3	ø3.8	ø4.3	ø5.0
	0.5	IPD/JA-IN-00/3D	IPD/JA-IR-00/3D	IPD/JA-IW-00/3D	IPD/JA-IX-00/3D
	1.5	IPD/JA-IN-02/3D	IPD/JA-IR-02/3D	IPD/JA-IW-02/3D	IPD/JA-IX-02/3D
Cutting guide KIT		IPD/KT-IN-00	IPD/KT-IR-00	IPD/KT-IW-00	IPD/KT-IW-00
	0.5	IPD/JA-IN-01/3D	IPD/JA-IR-01/3D	IPD/JA-IW-01/3D	IPD/JA-IX-01/3D
	1.5	IPD/JA-IN-03/3D	IPD/JA-IR-03/3D	IPD/JA-IW-03/3D	IPD/JA-IX-03/3D
Cutting guide KIT		IPD/KT-IN-01	IPD/KT-IR-01	IPD/KT-IW-01	IPD/KT-IW-01

Please see page 204 for the IPD Custom Interface System accessories.



IPDMILLED SYSTEM*

*Check availability

Indication	Material	Diameter (mm)	ø3.3	ø3.8	ø4.3	ø5.0
IPD Blank System (Compatible with NT/IPD Holders)						
	Ti	12	IPD/JA-XN-00	IPD/JA-XR-00	IPD/JA-XW-00	IPD/JA-XX-00
Mill Analog						
			IPD/JA-AN-00/X	IPD/JA-AR-00/X	IPD/JA-AW-00/X	IPD/JA-AX-00/X
TYPE A System (Compatible with DESS® Holders)						
	Ti	15	PR/JA-XN-15/A	PR/JA-XR-15/A	PR/JA-XW-15/A	PR/JA-XX-15/A

All premilled abutments include 2 titanium screws.



[RETURN TO INDEX](#)

SCREWS

			ø3.3	ø3.8	ø4.3	ø5.0
IPD and OEM compatible	For straight channels	Torque value	20 Ncm	20 Ncm	20 Ncm	20 Ncm
Screwdriver	Coating	Seat				
1.25 Hex	-	Conical	IPD/JA-TR-00	IPD/JA-TR-00	IPD/JA-TR-00	IPD/JA-TX-00
1.25 Hex	TiN	Conical	IPD/JA-TR-00/TiN	IPD/JA-TR-00/TiN	IPD/JA-TR-00/TiN	IPD/JA-TX-00/TiN
1.25 Hex	BLC	Conical	IPD/JA-TR-00/BLC	IPD/JA-TR-00/BLC	IPD/JA-TR-00/BLC	IPD/JA-TX-00/BLC



MULTI-UNIT ABUTMENT

Angulation	Indication	Gingival Height (mm)	ø3.3	ø3.8	ø4.3	ø5.0
0°		1.0	-	IPD/JA-MR-01	IPD/JA-MW-01	IPD/JA-MX-01
		2.0	-	IPD/JA-MR-02	IPD/JA-MW-02	IPD/JA-MX-02

Straight Multi-unit abutments can be used for single and multiple restorations. Please see page 206 for the Multi-unit system accessories.



MULTI-UNIT AP ABUTMENT* NEW

*Check availability

Angulation	Indication	Gingival Height (mm)	ø3.3	ø3.8	ø4.3	ø5.0
17°		2.5	-	IPD/JA-MR-12/AP	IPD/JA-MW-12/AP	IPD/JA-MX-12/AP
		3.5	-	IPD/JA-MR-13/AP	IPD/JA-MW-13/AP	IPD/JA-MX-13/AP
30°		3.5	-	IPD/JA-MR-33/AP	IPD/JA-MW-33/AP	IPD/JA-MX-33/AP
		4.5	-	IPD/JA-MR-34/AP	IPD/JA-MW-34/AP	IPD/JA-MX-34/AP
	Replacement Screw for Angled MUA AP	-	-	IPD/KA-MT-16/BLC	IPD/KA-MT-16/BLC	IPD/KA-MT-06/BLC

Please see page 206 for the Multi-unit system accessories.



ANALOGS

Type		ø3.3	ø3.8	ø4.3	ø5.0
Standard		IPD/JA-AN-00	IPD/JA-AR-00	IPD/JA-AW-00	IPD/JA-AX-00
	Full set	IPD/JA-AN-90/3D	IPD/JA-AR-90/3D	IPD/JA-AW-90/3D	IPD/JA-AX-90/3D
Digital	Analog				
	Bottom Screw				
	Side Screw				



PSD OVERDENTURE ABUTMENT

Indication	Gingival Height (mm)	ø3.3	ø3.8	ø4.3	ø5.0
	1.0	-	IPD/JA-LR-01	IPD/JA-LW-01	IPD/JA-LX-01
	2.0	-	-	-	IPD/JA-LX-02
	3.0	-	IPD/JA-LR-03	IPD/JA-LW-03	IPD/JA-LX-03
	4.0	-	-	-	IPD/JA-LX-04
	5.0	-	IPD/JA-LR-05	IPD/JA-LW-05	-

Please see page 205 for the PSD system accessories.



TEMPORARY ABUTMENT / OPEN TRAY COPING

Indication	Gingival Height (mm)	ø3.3	ø3.8	ø4.3	ø5.0
	1.5	IPD/JA-PN-06	IPD/JA-PR-06	IPD/JA-PW-06	IPD/JA-PX-06
	1.5	IPD/JA-PN-07	IPD/JA-PR-07	IPD/JA-PW-07	IPD/JA-PX-07
	Long coping screw	IPD/JA-TR-00/C	IPD/JA-TR-00/C	IPD/JA-TR-00/C	IPD/JA-TX-00/C

The same abutment can be used as a temporary abutment with the occlusal screw or as an impression coping using the coping screw.



HEALING ABUTMENT

Gingival Height (mm)	Head Diameter (mm)	ø3.3	ø3.8	ø4.3	ø5.0
		2.0	IPD/JA-DN-02	IPD/JA-DR-02	IPD/JA-DW-02
4.0		IPD/JA-DN-04	IPD/JA-DR-04	IPD/JA-DW-04	IPD/JA-DX-04
6.0		IPD/JA-DN-06	IPD/JA-DR-06	IPD/JA-DW-06	IPD/JA-DX-06



SCREWDRIVERS

Type	Length (mm)	ø3.3	ø3.8	ø4.3	ø5.0
Implant system Screwdriver					
1.25 Hex	18	IPD/PH-25-18	IPD/PH-25-18	IPD/PH-25-18	IPD/PH-25-18
	25	IPD/PH-25-25	IPD/PH-25-25	IPD/PH-25-25	IPD/PH-25-25
	32	IPD/PH-25-32	IPD/PH-25-32	IPD/PH-25-32	IPD/PH-25-32
IPD Scan Body and extra Screwdrivers					
1.20 Hex	18	IPD/PH-20-18	IPD/PH-20-18	IPD/PH-20-18	IPD/PH-20-18
	25	IPD/PH-20-25	IPD/PH-20-25	IPD/PH-20-25	IPD/PH-20-25
	32	IPD/PH-20-32	IPD/PH-20-32	IPD/PH-20-32	IPD/PH-20-32
PSD Screwdriver					
PSD	25	-	IPD/LL-PS-00	IPD/LL-PS-00	IPD/LL-PS-00



ACCESSORIES

Indication	Length (mm)	ø3.3	ø3.8	ø4.3	ø5.0
Clinical RA Shank Handle	16	IPD/MC-00-16	IPD/MC-00-16	IPD/MC-00-16	IPD/MC-00-16
Laboratory RA Shank Handle	70	IPD/ML-00-70	IPD/ML-00-70	IPD/ML-00-70	IPD/ML-00-70
RA Shank Ratchet	90	IPD/DI-00-90	IPD/DI-00-90	IPD/DI-00-90	IPD/DI-00-90
Ratchet adapter		IPD/DI-KA-90	IPD/DI-KA-90	IPD/DI-KA-90	IPD/DI-KA-90
PSD and insert extractor tool		-	IPD/LL-PS-01	IPD/LL-PS-01	IPD/LL-PS-01

Please see page 210 for more information.



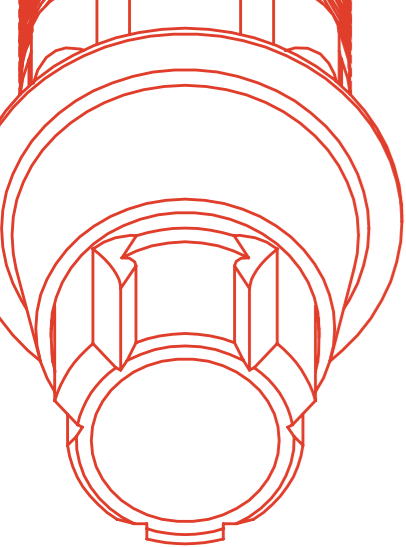

CAMLOG®

JB CONELOG®

Prosthetic platform [Ø3.3 / Ø3.8 / Ø4.3 / Ø5.0]

SCAN BODY

Indication	Height (mm)	Ø3.3	Ø3.8	Ø4.3	Ø5.0
Scan Body	10	IPD/JB-ST-00	IPD/JB-SN-00	IPD/JB-SR-00	IPD/JB-SW-00
	15	IPD/JB-ST-02	IPD/JB-SN-02	IPD/JB-SR-02	IPD/JB-SW-02
	10	IPD/JB-ST-01	IPD/JB-SN-01	IPD/JB-SR-01	IPD/JB-SW-01

Captive screw included. 1.20 Hex Screwdriver.

Ti-BASE Custom Ti-Base System*

Indication	Gingival Height (mm)	Ø3.3	Ø3.8	Ø4.3	Ø5.0
Scan Body	0.5	IPD/JB-IT-00/3D	IPD/JB-IN-00/3D	IPD/JB-IR-00/3D	IPD/JB-IW-00/3D
	1.5	IPD/JB-IT-02/3D	IPD/JB-IN-02/3D	IPD/JB-IR-02/3D	IPD/JB-IW-02/3D
Cutting guide KIT		IPD/KT-IN-00	IPD/KT-IR-00	IPD/KT-IR-00	IPD/KT-IW-00
Scan Body	0.5	IPD/JB-IT-01/3D	IPD/JB-IN-01/3D	IPD/JB-IR-01/3D	IPD/JB-IW-01/3D
	1.5	IPD/JB-IT-03/3D	IPD/JB-IN-03/3D	IPD/JB-IR-03/3D	IPD/JB-IW-03/3D
Cutting guide KIT		IPD/KT-IN-01	IPD/KT-IR-01	IPD/KT-IR-01	IPD/KT-IW-01

Please see page 204 for the IPD Custom Interface System accessories.

IPDMILLED SYSTEM*

*Check availability

Indication	Material	Diameter (mm)	Ø3.3	Ø3.8	Ø4.3	Ø5.0
IPD Blank System (Compatible with NT/IPD Holders)						
	Ti	12	IPD/JB-XT-00	IPD/JB-XR-00	IPD/JB-XR-00	IPD/JB-XW-00
Mill Analog			IPD/JB-AT-00/X	IPD/JB-AR-00/X	IPD/JB-AR-00/X	IPD/JB-AW-00/X
TYPE A System (Compatible with DESS® Holders)						
	Ti	15	-	PR/JB-XN-15/A	PR/JB-XR-15/A	-

All premilled abutments include 2 titanium screws.

SCREWS

IPD and OEM compatible	For straight channels	Torque value	Ø3.3	Ø3.8	Ø4.3	Ø5.0
			20 Ncm	20 Ncm	20 Ncm	20 Ncm
Screwdriver	Coating	Seat				
1.25 Hex	-	Conical	IPD/JB-TR-00	IPD/JB-TR-00	IPD/JB-TR-00	IPD/JB-TW-00
1.25 Hex	TiN	Conical	IPD/JB-TR-00/TiN	IPD/JB-TR-00/TiN	IPD/JB-TR-00/TiN	IPD/JB-TW-00/TiN
1.25 Hex	BLC	Conical	IPD/JB-TR-00/BLC	IPD/JB-TR-00/BLC	IPD/JB-TR-00/BLC	IPD/JB-TW-00/BLC
Removing tool		Conical	IPD/JB-TR-01	IPD/JB-TR-01	IPD/JB-TR-01	IPD/JB-TW-01



[RETURN TO INDEX](#)

MULTI-UNIT ABUTMENT

Angulation	Indication	Gingival Height (mm)	Ø3.3	Ø3.8	Ø4.3	Ø5.0
0°		1.5	-	IPD/JB-MN-01	IPD/JB-MR-01	IPD/JB-MW-01
		2.5	-	IPD/JB-MN-02	IPD/JB-MR-02	IPD/JB-MW-02

Straight Multi-unit abutments can be used for single and multiple restorations. Please see page 206 for the Multi-unit system accessories.

MULTI-UNIT AP ABUTMENT

*Check availability

Angulation	Indication	Gingival Height (mm)	Ø3.3	Ø3.8	Ø4.3	Ø5.0
17°		2.5	-	IPD/JB-MN-12/AP	IPD/JB-MR-12/AP	IPD/JB-MW-12/AP
		3.5	-	IPD/JB-MN-13/AP	IPD/JB-MR-13/AP	IPD/JB-MW-13/AP
30°		3.5	-	IPD/JB-MN-33/AP	IPD/JB-MR-33/AP	IPD/JB-MW-33/AP
		4.5	-	IPD/JB-MN-34/AP	IPD/JB-MR-34/AP	IPD/JB-MW-34/AP
Replacement Screw for Angled MUA AP			-	IPD/KA-MT-05/BLC	IPD/KA-MT-05/BLC	IPD/KA-MT-13/BLC

Please see page 206 for the Multi-unit system accessories.

ANALOGS

Type		Ø3.3	Ø3.8	Ø4.3	Ø5.0
Standard		IPD/JB-AT-00	IPD/JB-AN-00	IPD/JB-AR-00	IPD/JB-AW-00
	Full set	IPD/JB-AT-90/3D	IPD/JB-AN-90/3D	IPD/JB-AR-90/3D	IPD/JB-AW-90/3D
Digital	Analog				
	Bottom Screw				
	Side Screw				

PSD OVERDENTURE ABUTMENT

Indication	Gingival Height (mm)	Ø3.3	Ø3.8	Ø4.3	Ø5.0
	2.0	-	IPD/JB-LN-02	IPD/JB-LR-02	IPD/JB-LW-02
	3.0	-	IPD/JB-LN-03	IPD/JB-LR-03	IPD/JB-LW-03
	4.0	-	IPD/JB-LN-04	IPD/JB-LR-04	IPD/JB-LW-04

Please see page 205 for the PSD system accessories.

TEMPORARY ABUTMENT / OPEN TRAY COPING

Indication	Gingival Height (mm)	Ø3.3	Ø3.8	Ø4.3	Ø5.0
	1.5	IPD/JB-PT-06	IPD/JB-PN-06	IPD/JB-PR-06	IPD/JB-PW-06
	1.5	IPD/JB-PT-07	IPD/JB-PN-07	IPD/JB-PR-07	IPD/JB-PW-07
Long coping screw		IPD/JB-TR-00/C	IPD/JB-TR-00/C	IPD/JB-TR-00/C	IPD/JB-TW-00/C

The same abutment can be used as a temporary abutment with the occlusal screw or as an impression coping using the coping screw.

HEALING ABUTMENT

Gingival Height (mm)	Head Diameter (mm)	Ø3.3	Ø3.8	Ø4.3	Ø5.0
2.0	Ø 3.5	IPD/JB-DT-02	IPD/JB-DN-02	IPD/JB-DR-02	IPD/JB-DW-02
4.0	Ø 4.0	IPD/JB-DT-04	IPD/JB-DN-04	IPD/JB-DR-04	IPD/JB-DW-04
6.0	Ø 4.5	IPD/JB-DT-06	IPD/JB-DN-06	IPD/JB-DR-06	IPD/JB-DW-06



SCREWDRIVERS

Type	Length (mm)	φ3.3	φ3.8	φ4.3	5.0
Implant system Screwdriver					
1.25 Hex	18	IPD/PH-25-18	IPD/PH-25-18	IPD/PH-25-18	IPD/PH-25-18
	25	IPD/PH-25-25	IPD/PH-25-25	IPD/PH-25-25	IPD/PH-25-25
	32	IPD/PH-25-32	IPD/PH-25-32	IPD/PH-25-32	IPD/PH-25-32
IPD Scan Body and extra Screwdrivers					
1.20 Hex	18	IPD/PH-20-18	IPD/PH-20-18	IPD/PH-20-18	IPD/PH-20-18
	25	IPD/PH-20-25	IPD/PH-20-25	IPD/PH-20-25	IPD/PH-20-25
	32	IPD/PH-20-32	IPD/PH-20-32	IPD/PH-20-32	IPD/PH-20-32
PSD Screwdriver					
PSD	25	-	IPD/LL-PS-00	IPD/LL-PS-00	IPD/LL-PS-00



ACCESSORIES

Indication	Length (mm)	φ3.3	φ3.8	φ4.3	5.0
Clinical RA Shank Handle	16	IPD/MC-00-16	IPD/MC-00-16	IPD/MC-00-16	IPD/MC-00-16
Laboratory RA Shank Handle	70	IPD/ML-00-70	IPD/ML-00-70	IPD/ML-00-70	IPD/ML-00-70
RA Shank Ratchet	90	IPD/DI-00-90	IPD/DI-00-90	IPD/DI-00-90	IPD/DI-00-90
Ratchet adapter		IPD/DI-KA-90	IPD/DI-KA-90	IPD/DI-KA-90	IPD/DI-KA-90
PSD and insert extractor tool		-	IPD/LL-PS-01	IPD/LL-PS-01	IPD/LL-PS-01



Please see page 210 for more information.

BIOHORIZONS®

LB TAPERED INTERNAL

Prosthetic platform [φ3.0 / φ3.5 / φ4.5 / φ5.7]

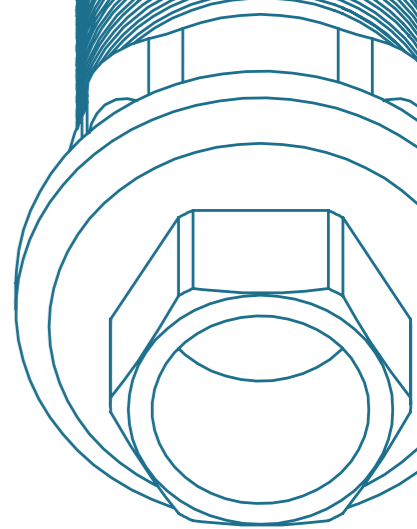

SCAN BODY

	Indication	Height (mm)	φ3.0	φ3.5	φ4.5	φ5.7
Scan Body		10	IPD/LB-ST-00	IPD/LB-SN-00	IPD/LB-SR-00	IPD/LB-SW-00
		15	IPD/LB-ST-02	IPD/LB-SN-02	IPD/LB-SR-02	IPD/LB-SW-02
		10	IPD/LB-ST-01	IPD/LB-SN-01	IPD/LB-SR-01	IPD/LB-SW-01



Captive screw included. 1.20 Hex Screwdriver.

Ti-BASE Custom Ti-Base System®

Indication	Gingival Height (mm)	φ3.0	φ3.5	φ4.5	φ5.7
	0.5	IPD/LB-IT-00/3D	IPD/LB-IN-00/3D	IPD/LB-IR-00/3D	IPD/LB-IW-00/3D
	1.5	IPD/LB-IT-02/3D	IPD/LB-IN-02/3D	IPD/LB-IR-02/3D	-
	2.5	IPD/LB-IT-04/3D	IPD/LB-IN-04/3D	IPD/LB-IR-04/3D	-
	Cutting guide KIT	IPD/KT-IN-00	IPD/KT-IN-00	IPD/KT-IR-00	IPD/KT-IW-00
	0.5	IPD/LB-IT-01/3D	IPD/LB-IN-01/3D	IPD/LB-IR-01/3D	IPD/LB-IW-01/3D
	1.5	IPD/LB-IT-03/3D	IPD/LB-IN-03/3D	IPD/LB-IR-03/3D	-
	2.5	IPD/LB-IT-05/3D	IPD/LB-IN-05/3D	IPD/LB-IR-05/3D	-
	Cutting guide KIT	IPD/KT-IN-01	IPD/KT-IN-01	IPD/KT-IR-01	IPD/KT-IW-01



Please see page 204 for the IPD Custom Interface System accessories.

IPDMILLED SYSTEM*

*Check availability

Indication	Material	Diameter (mm)	φ3.0	φ3.5	φ4.5	φ5.7
IPD Blank System (Compatible with NT/IPD Holders)						
	Ti	12	IPD/LB-XT-00	IPD/LB-XN-00	IPD/LB-XR-00	IPD/LB-XW-00
Mill Analog			IPD/LB-AT-00/X	IPD/LB-AN-00/X	IPD/LB-AR-00/X	IPD/LB-AW-00/X
TYPE A System (Compatible with DESS® Holders)						
	Ti	15	PR/LB-XT-15/A	PR/LB-XN-15/A	PR/LB-XR-15/A	-



All premilled abutments include 2 titanium screws.

SCREWS

			φ3.0	φ3.5	φ4.5	φ5.7
IPD and OEM compatible	For straight channels	Torque value	35 Ncm	35 Ncm	35 Ncm	35 Ncm
Screwdriver	Coating	Seat				
1.25 Hex	-	Conical	IPD/LB-TR-00	IPD/LB-TR-00	IPD/LB-TR-00	IPD/LB-TR-00
1.25 Hex	TiN	Conical	IPD/LB-TR-00/TiN	IPD/LB-TR-00/TiN	IPD/LB-TR-00/TiN	IPD/LB-TR-00/TiN
1.25 Hex	BLC	Conical	IPD/LB-TR-00/BLC	IPD/LB-TR-00/BLC	IPD/LB-TR-00/BLC	IPD/LB-TR-00/BLC
	For ASC options	Torque value	25 Ncm	25 Ncm	25 Ncm	25 Ncm
Screwdriver	Coating	Seat				
TPA	TiN	Conical	IPD/LB-TR-50	IPD/LB-TR-50	IPD/LB-TR-50	IPD/LB-TR-50



RETURN TO INDEX

MULTI-UNIT ABUTMENT

Angulation	Indication	Gingival Height (mm)	ø3.0	ø3.5	ø4.5	ø5.7
0°		0.9	-	IPD/FA-MN-00	-	-
		1.0	IPD/LB-MT-01	-	-	-
		1.5	-	IPD/FA-MN-01	IPD/FA-MR-01	-
		2.0	IPD/LB-MT-02	-	-	-
		2.5	-	IPD/FA-MN-02	IPD/FA-MR-02	-
		3.0	IPD/LB-MT-03	-	-	-
		3.5	-	IPD/FA-MN-03	IPD/FA-MR-03	-
17°		2.5	-	IPD/LB-MN-12	-	-
		3.5	-	IPD/LB-MN-13	-	-
		3.5	-	IPD/LB-MN-33	-	-
30°		3.5	-	IPD/LB-MN-33	-	-
		4.5	-	IPD/LB-MN-34	-	-
Replacement Screw for Angled MUA		-	-	IPD/KA-MT-08	-	-

Straight Multi-unit abutments can be used for single and multiple restorations. Please see page 206 for the Multi-unit system accessories.



MULTI-UNIT AP ABUTMENT* NEW

*Check availability

Angulation	Indication	Gingival Height (mm)	ø3.0	ø3.5	ø4.5	ø5.7
17°		2.5	-	IPD/LB-MN-12/AP	-	-
		3.5	-	IPD/LB-MN-13/AP	-	-
30°		3.5	-	IPD/LB-MN-33/AP	-	-
		4.5	-	IPD/LB-MN-34/AP	-	-
Replacement Screw for Angled MUA AP		-	-	IPD/KA-MT-08/BLC	-	-

Please see page 206 for the Multi-unit system accessories.



ANALOGS

Type		ø3.0	ø3.5	ø4.5	ø5.7
Standard		IPD/LB-AT-00	IPD/LB-AN-00	IPD/LB-AR-00	IPD/LB-AW-00
	Full set	IPD/LB-AT-90/3D	IPD/LB-AN-90/3D	IPD/LB-AR-90/3D	IPD/LB-AW-90/3D
Digital	Analog				
	Bottom Screw				
	Side Screw				



Co-Cr BASE ABUTMENT

		ø3.0	ø3.5	ø4.5	ø5.7
Co-Cr Base for analogic workflow					
Indication	Angulation				
	0°	IPD/LB-BT-00	IPD/LB-BN-00	IPD/LB-BR-00	-
	15°	IPD/LB-BT-10	IPD/LB-BN-10	IPD/LB-BR-10	-
	25°	IPD/LB-BT-20	IPD/LB-BN-20	IPD/LB-BR-20	-
	0°	IPD/LB-BT-01	IPD/LB-BN-01	IPD/LB-BR-01	-
	15°	IPD/LB-BT-11	IPD/LB-BN-11	IPD/LB-BR-11	-
	25°	IPD/LB-BT-21	IPD/LB-BN-21	IPD/LB-BR-21	-
Co-Cr Base for digital workflow					
Indication	Angulation				
	Straight/ASC	IPD/LB-BT-00/3D	IPD/LB-BN-00/3D	IPD/LB-BR-00/3D	-
	Straight/ASC	IPD/LB-BT-01/3D	IPD/LB-BN-01/3D	IPD/LB-BR-01/3D	-
Scan Body		IPD/SC-AN-B1	IPD/SC-AN-B1	IPD/SC-AN-B1	-

All ASC CoCr analogic workflow abutments include the relevant TPA screw.



CASTABLE ABUTMENT

Indication	ø3.0	ø3.5	ø4.5	ø5.7
	-	IPD/LB-HN-00	IPD/LB-HR-00	IPD/LB-HW-00
	-	IPD/LB-RN-00	IPD/LB-RR-00	IPD/LB-RW-00



PSD OVERDENTURE ABUTMENT

Indication	Gingival Height (mm)	ø3.0	ø3.5	ø4.5	ø5.7
	1.0	-	IPD/FA-LN-01	IPD/FA-LR-01	-
	2.0	IPD/LB-LT-02	IPD/FA-LN-02	IPD/FA-LR-02	-
	3.0	IPD/LB-LT-03	IPD/FA-LN-03	IPD/FA-LR-03	-
	4.0	IPD/LB-LT-04	IPD/FA-LN-04	IPD/FA-LR-04	-
	5.0	IPD/LB-LT-05	IPD/FA-LN-05	IPD/FA-LR-05	-

Please see page 205 for the PSD system accessories.



COPING ABUTMENT

Type	ø3.0	ø3.5	ø4.5	ø5.7
Open tray	-	-	-	IPD/LB-CW-00

Classic Design



TEMPORARY ABUTMENT / OPEN TRAY COPING

Indication	Gingival Height (mm)	ø3.0	ø3.5	ø4.5	ø5.7
	1.5	IPD/LB-PT-06	IPD/LB-PN-06	IPD/LB-PR-06	IPD/LB-PW-06
	1.5	IPD/LB-PT-07	IPD/LB-PN-07	IPD/LB-PR-07	IPD/LB-PW-07
Long coping screw		IPD/LB-TR-00/C	IPD/LB-TR-00/C	IPD/LB-TR-00/C	IPD/LB-TR-00/C

The same abutment can be used as a temporary abutment with the occlusal screw or as an impression coping using the coping screw.



HEALING ABUTMENT

Gingival Height (mm)	Head Diameter (mm)	ø3.0	ø3.5	ø4.5	ø5.7
1.5	-	-	IPD/FA-DN-01	IPD/FA-DR-01	-
2.0	IPD/LB-DT-02	-	-	-	-
3.0	IPD/LB-DT-03	IPD/FA-DN-03	IPD/FA-DR-03	IPD/FA-DW-03	-
5.0	IPD/LB-DT-05	IPD/FA-DN-05	IPD/FA-DR-05	IPD/FA-DW-05	-



SCREWDRIVERS

Type	Length (mm)	ø3.0	ø3.5	ø4.5	ø5.7
Implant system Screwdriver					
1.27 Hex	18	IPD/PH-27-18	IPD/PH-27-18	IPD/PH-27-18	IPD/PH-27-18
	25	IPD/PH-27-25	IPD/PH-27-25	IPD/PH-27-25	IPD/PH-27-25
	32	IPD/PH-27-32	IPD/PH-27-32	IPD/PH-27-32	IPD/PH-27-32
IPD Scan Body and extra Screwdrivers					
1.20 Hex	18	IPD/PH-20-18	IPD/PH-20-18	IPD/PH-20-18	IPD/PH-20-18
	25	IPD/PH-20-25	IPD/PH-20-25	IPD/PH-20-25	IPD/PH-20-25
	32	IPD/PH-20-32	IPD/PH-20-32	IPD/PH-20-32	IPD/PH-20-32
ASC Screwdriver					
TPA	18	IPD/KA-CT-18	IPD/KA-CT-18	IPD/KA-CT-18	IPD/KA-CT-18
	25	IPD/KA-CT-25	IPD/KA-CT-25	IPD/KA-CT-25	IPD/KA-CT-25
	32	IPD/KA-CT-32	IPD/KA-CT-32	IPD/KA-CT-32	IPD/KA-CT-32
PSD Screwdriver					
PSD	25	IPD/LL-PS-00	IPD/LL-PS-00	IPD/LL-PS-00	-



ACCESSORIES

Indication	Length (mm)	ø3.0	ø3.5	ø4.5	ø5.7
Clinical RA Shank Handle	16	IPD/MC-00-16	IPD/MC-00-16	IPD/MC-00-16	IPD/MC-00-16
Laboratory RA Shank Handle	70	IPD/ML-00-70	IPD/ML-00-70	IPD/ML-00-70	IPD/ML-00-70
RA Shank Ratchet	90	IPD/DI-00-90	IPD/DI-00-90	IPD/DI-00-90	IPD/DI-00-90
Ratchet adapter		IPD/DI-KA-90	IPD/DI-KA-90	IPD/DI-KA-90	IPD/DI-KA-90
PSD and insert extractor tool		IPD/LL-PS-01	IPD/LL-PS-01	IPD/LL-PS-01	-

Please see page 210 for more information.



BIOHORIZONS®

LC TAPERED PRO CONICAL

Prosthetic platform [Narrow ø3.3 / Regular ø3.8]

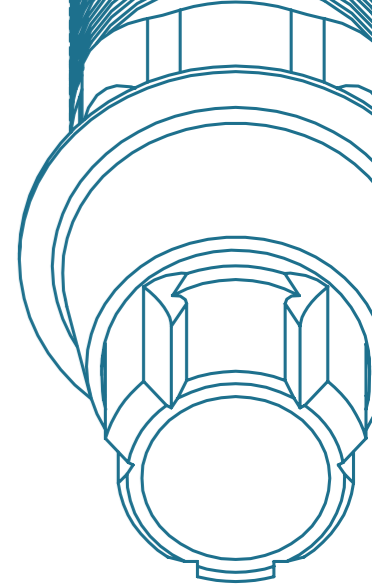

SCAN BODY

Indication	Height (mm)	Narrow ø3.3	Regular ø3.8	
			For Slim Restorative	For Regular Restorative
Scan Body	10	IPD/JB-ST-00	IPD/JB-SN-00	IPD/JB-SR-00
	15	IPD/JB-ST-02	IPD/JB-SN-02	IPD/JB-SR-02
	10	IPD/JB-ST-01	IPD/JB-SN-01	IPD/JB-SR-01

Captive screw included. 1.20 Hex Screwdriver.



Ti-BASE **ipd** Custom Ti-Base System®

Indication	Gingival Height (mm)	Narrow ø3.3	Regular ø3.8	
			For Slim Restorative	For Regular Restorative
Single crown	0.5	IPD/JB-IT-00/3D	IPD/JB-IN-00/3D	IPD/JB-IR-00/3D
	1.5	IPD/JB-IT-02/3D	IPD/JB-IN-02/3D	IPD/JB-IR-02/3D
Full arch	0.5	Cutting guide KIT	IPD/KT-IN-00	IPD/KT-IR-00
		IPD/JB-IT-01/3D	IPD/JB-IN-01/3D	IPD/JB-IR-01/3D
	1.5	Cutting guide KIT	IPD/KT-IN-01	IPD/KT-IR-01
		IPD/JB-IT-03/3D	IPD/JB-IN-03/3D	IPD/JB-IR-03/3D

Please see page 204 for the IPD Custom Interface System accessories.



IPDMILLED SYSTEM* **NEW**

*Check availability

Indication	Material	Diameter (mm)	Narrow ø3.3	Regular ø3.8
IPD Blank System (Compatible with NT/IPD Holders)				
	Ti	12	IPD/JB-XT-00	IPD/JB-XR-00
Mill Analog			IPD/JB-AT-00/X	IPD/JB-AR-00/X
TYPE A System (Compatible with DESS® Holders)				
	Ti	15	-	PR/JB-XR-15/A

All premilled abutments include 2 titanium screws.



RETURN TO INDEX

SCREWS

IPD and OEM compatible	For straight channels	Torque value	Narrow ø3.3	Regular ø3.8
			20 Ncm	20 Ncm
Screwdriver	Coating	Seat		
1.25 Hex	-	Conical	IPD/JB-TR-00	IPD/JB-TR-00
1.25 Hex	TiN	Conical	IPD/JB-TR-00/TIN	IPD/JB-TR-00/TIN
1.25 Hex	BLC	Conical	IPD/JB-TR-00/BLC	IPD/JB-TR-00/BLC
Screwdriver	Type			
Removing tool	Conical		IPD/JB-TR-01	IPD/JB-TR-01



MULTI-UNIT ABUTMENT

Angulation	Indication	Gingival Height (mm)	Narrow ø3.3	Regular ø3.8
0°		1.5	-	IPD/JB-MN-01
		2.5	-	IPD/JB-MN-02

Straight Multi-unit abutments can be used for single and multiple restorations. Please see page 206 for the Multi-unit system accessories.



MULTI-UNIT AP ABUTMENT* NEW

*Check availability

Angulation	Indication	Gingival Height (mm)	Narrow ø3.3	Regular ø3.8
17°		2.5	-	IPD/JB-MN-12/AP
				IPD/JB-MN-13/AP
30°		3.5	-	IPD/JB-MN-33/AP
				IPD/JB-MN-34/AP
Replacement Screw for Angled MUA AP				IPD/KA-MT-05/BLC

Please see page 206 for the Multi-unit system accessories.



ANALOGS

Type	Narrow ø3.3		Regular ø3.8	
	For Slim Restorative		For Regular Restorative	
Standard	IPD/JB-AT-00		IPD/JB-AN-00	IPD/JB-AR-00
	Full set	IPD/JB-AT-90/3D	IPD/JB-AN-90/3D	IPD/JB-AR-90/3D
Digital	Analogue	-	-	-
	Components	Bottom Screw	-	-
		Side Screw	-	-



PSD OVERDENTURE ABUTMENT

Indication	Gingival Height (mm)	Narrow ø3.3	Regular ø3.8
	2.0	-	IPD/JB-LN-02
	3.0	-	IPD/JB-LN-03
	4.0	-	IPD/JB-LN-04

Please see page 205 for the PSD system accessories.



TEMPORARY ABUTMENT / OPEN TRAY COPING

Indication	Gingival Height (mm)	Narrow ø3.3	Regular ø3.8	
			For Slim Restorative	For Regular Restorative
	1.5	IPD/JB-PT-06	IPD/JB-PN-06	IPD/JB-PR-06
	1.5	IPD/JB-PT-07	IPD/JB-PN-07	IPD/JB-PR-07
Long coping screw		IPD/JB-TR-00/C	IPD/JB-TR-00/C	IPD/JB-TR-00/C

The same abutment can be used as a temporary abutment with the occlusal screw or as an impression coping using the coping screw.



HEALING ABUTMENT

Gingival Height (mm)	Narrow ø3.3		Regular ø3.8	
	For Slim Restorative		For Regular Restorative	
	Head Diameter (mm)			
2.0	ø3.5		ø4.0	ø4.5
	IPD/JB-DT-02	IPD/JB-DN-02	IPD/JB-DR-02	IPD/JB-DR-02
4.0	IPD/JB-DT-04	IPD/JB-DN-04	IPD/JB-DR-04	IPD/JB-DR-04
6.0	IPD/JB-DT-06	IPD/JB-DN-06	IPD/JB-DR-06	IPD/JB-DR-06



SCREWDRIVERS

Type	Length (mm)	Narrow ø3.3	Regular ø3.8
Implant system Screwdriver			
1.25 Hex	18	IPD/PH-25-18	IPD/PH-25-18
	25	IPD/PH-25-25	IPD/PH-25-25
	32	IPD/PH-25-32	IPD/PH-25-32
IPD Scan Body and extra Screwdrivers			
1.20 Hex	18	IPD/PH-20-18	IPD/PH-20-18
	25	IPD/PH-20-25	IPD/PH-20-25
	32	IPD/PH-20-32	IPD/PH-20-32
PSD Screwdriver			
PSD	25	-	IPD/LL-PS-00



ACCESSORIES

Indication	Length (mm)	Narrow ø3.3	Regular ø3.8
Clinical RA Shank Handle	16	IPD/MC-00-16	IPD/MC-00-16
Laboratory RA Shank Handle	70	IPD/ML-00-70	IPD/ML-00-70
RA Shank Ratchet	90	IPD/DI-00-90	IPD/DI-00-90
Ratchet adapter		IPD/DI-KA-90	IPD/DI-KA-90
PSD and insert extractor tool		-	IPD/LL-PS-01

Please see page 210 for more information.



SWEDEN & MARTINA

MA OUTLINK®

Prosthetic platform [ø3.3 / ø4.1 / ø5.0]

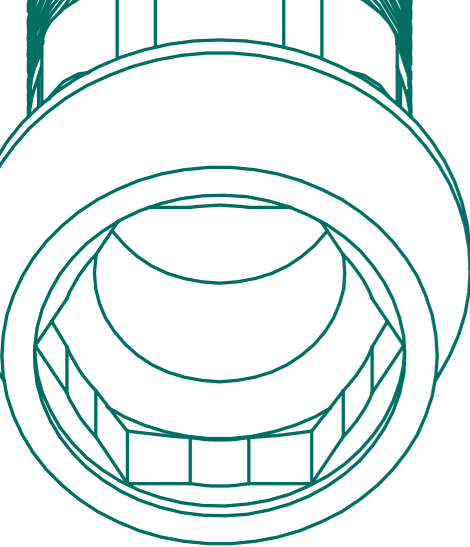

SCAN BODY

Indication	Height (mm)	ø3.3	ø4.1	ø5.0
Scan Body	10	IPD/MA-SN-00	IPD/AA-SR-00	IPD/BA-SW-00
	15	IPD/MA-SN-02	IPD/AA-SR-02	IPD/BA-SW-02
	10	IPD/MA-SN-01	IPD/AA-SR-01	IPD/BA-SW-01

Captive screw included. 1.20 Hex Screwdriver.



Ti-BASE Custom Ti-Base System®

Indication	Gingival Height (mm)	ø3.3	ø4.1	ø5.0
Single	0.5	-	IPD/AA-IR-00/3D	IPD/BA-IW-00/3D
	1.5	IPD/MA-IN-02/3D	IPD/AA-IR-02/3D	IPD/BA-IW-02/3D
	2.5	IPD/MA-IN-04/3D	IPD/AA-IR-04/3D	-
Cutting guide KIT		IPD/KT-IN-00	IPD/KT-IR-00	IPD/KT-IW-00
Full	0.5	-	IPD/AA-IR-01/3D	IPD/BA-IW-01/3D
	1.5	IPD/MA-IN-03/3D	IPD/AA-IR-03/3D	IPD/BA-IW-03/3D
	2.5	IPD/MA-IN-05/3D	IPD/AA-IR-05/3D	-
Cutting guide KIT		IPD/KT-IN-01	IPD/KT-IR-01	IPD/KT-IW-01

Please see page 204 for the IPD Custom Interface System accessories.



IPDMILLED SYSTEM*

*Check availability

Indication	Material	Diameter (mm)	ø3.3	ø4.1	ø5.0
TYPE A System (Compatible with DESS® Holders)					
	Ti	15	PR/MA-XN-15/A	PR/MA-XR-15/A	PR/MA-XW-15/A

All premilled abutments include 2 titanium screws.



SCREWS

IPD and OEM compatible	For straight channels	Torque value	ø3.3	ø4.1	ø5.0
			25 Ncm	25 Ncm	25 Ncm
Screwdriver	Coating	Seat			
1.25 Hex	-	Conical	IPD/MA-TN-00	IPD/BA-TR-01	IPD/BA-TR-01
1.25 Hex	TiN	Conical	IPD/MA-TN-00/TiN	IPD/BA-TR-01/TiN	IPD/BA-TR-01/TiN
1.25 Hex	BLC	Conical	IPD/MA-TN-00/BLC	IPD/BA-TR-01/BLC	IPD/BA-TR-01/BLC

	For ASC options	Torque value	25 Ncm	25 Ncm	25 Ncm
Screwdriver	Coating	Seat			
TPA	TiN	Conical	IPD/MA-TN-50	IPD/AA-TR-50	IPD/AA-TR-50

Additional options	For straight channels	Torque value	20 Ncm	20 Ncm	
Screwdriver	Coating	Seat			
1.20 Hex	-	Low profile head - conical seat	-	IPD/AA-TR-01	IPD/AA-TR-01
1.20 Hex	TiN	Low profile head - conical seat	-	IPD/AA-TR-01/TiN	IPD/AA-TR-01/TiN
1.20 Hex	BLC	Low profile head - conical seat	-	IPD/AA-TR-01/BLC	IPD/AA-TR-01/BLC
TPA	TiN	For implant level flat seat	-	IPD/AA-TR-52	IPD/AA-TR-52



MULTI-UNIT ABUTMENT

Angulation	Indication	Gingival Height (mm)	ø3.3	ø4.1	ø5.0
0°	Single	1.0	-	IPD/AB-MR-01	-
		2.0	-	IPD/AB-MR-02	-
		3.0	-	IPD/AB-MR-03	-
		4.0	-	IPD/AB-MR-04	-
17°	Full	2.0	-	IPD/AB-MR-12	-
		3.0	-	IPD/AB-MR-13	-
		4.0	-	IPD/AB-MR-14	-
		5.0	-	IPD/AB-MR-05	-
30°	Full	3.0	-	IPD/AB-MR-33	-
		4.0	-	IPD/AB-MR-34	-
		5.0	-	IPD/AB-MR-35	-
		Replacement Screw for Angled MUA	-	IPD/KA-MT-00	-

Straight Multi-unit abutments can be used for single and multiple restorations. Please see page 206 for the Multi-unit system accessories.







ANALOGS

Type		ø3.3	ø4.1	ø5.0
Standard		IPD/MA-AN-00	IPD/AA-AR-00	IPD/BA-AW-00
	Full set	IPD/MA-AN-90/3D	IPD/AA-AR-90/3D	IPD/BA-AW-90/3D
Digital	Analogue			
	Bottom Screw			
	Side Screw			



[RETURN TO INDEX](#)



Co-Cr BASE ABUTMENT

		ø3.3	ø4.1	ø5.0
Co-Cr Base for analogic workflow				
Indication	Angulation			
	0°	IPD/MA-BN-00	IPD/AA-BR-00	IPD/BA-BW-00
	15°	IPD/MA-BN-10	IPD/AA-BR-10	IPD/BA-BW-10
	25°	-	IPD/AA-BR-20	IPD/BA-BW-20
	0°	IPD/MA-BN-01	IPD/AA-BR-01	IPD/BA-BW-01
	15°	IPD/MA-BN-11	IPD/AA-BR-11	IPD/BA-BW-11
	25°	-	IPD/AA-BR-21	IPD/BA-BW-21
Co-Cr Base for digital workflow				
Indication	Angulation			
	Straight/ASC	IPD/MA-BN-00/3D	IPD/AA-BR-00/3D	IPD/BA-BW-00/3D
	Straight/ASC	IPD/MA-BN-01/3D	IPD/AA-BR-01/3D	IPD/BA-BW-01/3D
	Scan Body	IPD/SC-AN-B1	IPD/SC-AN-B1	IPD/SC-AN-B1

All ASC CoCr analogic workflow abutments include the relevant TPA screw.



CASTABLE ABUTMENT

Indication	ø3.3	ø4.1	ø5.0
	-	IPD/AA-HR-00	IPD/BA-HW-00
	-	IPD/AA-RR-00	IPD/BA-RW-00



PSD OVERDENTURE ABUTMENT

Indication	Gingival Height (mm)	ø3.3	ø4.1	ø5.0
	1.0	-	IPD/AA-LR-01	-
	2.0	IPD/MA-LN-02	IPD/AA-LR-02	-
	3.0	IPD/MA-LN-03	IPD/AA-LR-03	-
	4.0	IPD/MA-LN-04	IPD/AA-LR-04	-
	5.0	IPD/MA-LN-05	IPD/AA-LR-05	-

Please see page 205 for the PSD system accessories.





COPING ABUTMENT

Type	ø3.3	ø4.1	ø5.0
Open tray	-	IPD/AA-CR-00	IPD/BA-CW-00
Closed tray	-	IPD/AA-CR-01	-

Classic Design



TEMPORARY ABUTMENT / OPEN TRAY COPING

Indication	Gingival Height (mm)	ø3.3	ø4.1	ø5.0
	1.5	IPD/MA-PN-06	IPD/AA-PR-06	IPD/BB-PW-06
	1.5	IPD/MA-PN-07	IPD/AA-PR-07	IPD/BB-PW-07
	Long coping screw	IPD/MA-TN-00/C	IPD/AA-TR-00/C	IPD/BB-TR-01/C

The same abutment can be used as a temporary abutment with the occlusal screw or as an impression coping using the coping screw.





HEALING ABUTMENT

Gingival Height (mm)	Head Diameter (mm)	ø3.3	ø4.1	ø5.0
2.0		-	IPD/AA-DR-02	IPD/BA-DW-02
3.0		IPD/MA-DN-03	IPD/AA-DR-03	IPD/BA-DW-03
4.0		IPD/MA-DN-04	IPD/AA-DR-04	IPD/BA-DW-04
5.0		IPD/MA-DN-05	IPD/AA-DR-05	-



TI CEMENT-RETAINED ABUTMENT

Indication	Angulation	Gingival Height	ø3.3	ø4.1	ø5.0
	0°	2.0	-	IPD/AA-PR-00	-
	15°	1.0	-	IPD/AA-PR-02	-
	25°	1.0	-	IPD/AA-PR-03	-
	0°	2.0	-	IPD/AA-PR-05	-
	15°	2.0	-	IPD/AA-PR-04	-
	25°	2.0	-	IPD/AA-PR-01	-



Using the Low profile IPD/AA-TR-01 screw for IPD/AA-PR-04 is recommended

SCREWDRIVERS

Type	Length (mm)	ø3.3	ø4.1	ø5.0
Implant system Screwdriver				
1.25 Hex	18	IPD/PH-25-18	IPD/PH-25-18	IPD/PH-25-18
	25	IPD/PH-25-25	IPD/PH-25-25	IPD/PH-25-25
	32	IPD/PH-25-32	IPD/PH-25-32	IPD/PH-25-32
IPD Scan Body and extra Screwdrivers				
1.20 Hex	18	IPD/PH-20-18	IPD/PH-20-18	IPD/PH-20-18
	25	IPD/PH-20-25	IPD/PH-20-25	IPD/PH-20-25
	32	IPD/PH-20-32	IPD/PH-20-32	IPD/PH-20-32
ASC Screwdriver				
TPA	18	IPD/KA-CT-18	IPD/KA-CT-18	IPD/KA-CT-18
	25	IPD/KA-CT-25	IPD/KA-CT-25	IPD/KA-CT-25
	32	IPD/KA-CT-32	IPD/KA-CT-32	IPD/KA-CT-32
PSD Screwdriver				
PSD	25	IPD/LL-PS-00	IPD/LL-PS-00	-



ACCESSORIES

Indication	Length (mm)	ø3.3	ø4.1	ø5.0
Clinical RA Shank Handle	16	IPD/MC-00-16	IPD/MC-00-16	IPD/MC-00-16
Laboratory RA Shank Handle	70	IPD/ML-00-70	IPD/ML-00-70	IPD/ML-00-70
RA Shank Ratchet	90	IPD/DI-00-90	IPD/DI-00-90	IPD/DI-00-90
Ratchet adapter		IPD/DI-KA-90	IPD/DI-KA-90	IPD/DI-KA-90
PSD and insert extractor tool		IPD/LL-PS-01	IPD/LL-PS-01	-

Please see page 210 for more information.



SWEDEN & MARTINA

MB PREMIUM™ KOHNO® Prosthetic platform [ø3.3 / ø3.8 / ø4.25 / ø5.0]

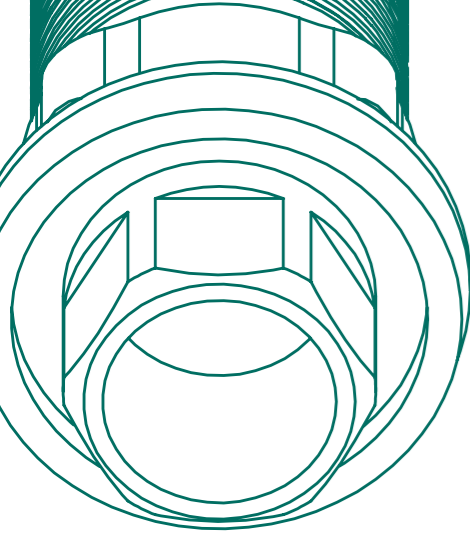

SCAN BODY

	Indication	Height (mm)	ø3.3	ø3.8	ø4.25	ø5.0
Scan Body		10	IPD/MB-ST-00	IPD/MB-SN-00	IPD/MB-SR-00	IPD/MB-SW-00
		15	IPD/MB-ST-02	IPD/MB-SN-02	IPD/MB-SR-02	IPD/MB-SW-02
		10	IPD/MB-ST-01	IPD/MB-SN-01	IPD/MB-SR-01	IPD/MB-SW-01

Captive screw included. 1.20 Hex Screwdriver.

Ti-BASE Custom Ti-Base System®

	Indication	Gingival Height (mm)	ø3.3	ø3.8	ø4.25	ø5.0
		0.5	IPD/MB-IT-00/3D	-	-	-
		0.7	-	IPD/MB-IN-00/3D	IPD/MB-IR-00/3D	-
		1.5	IPD/MB-IT-02/3D	IPD/MB-IN-02/3D	IPD/MB-IR-02/3D	-
	Cutting guide KIT		IPD/KT-IN-00	IPD/KT-IN-00	IPD/KT-IR-00	-
			0.5	IPD/MB-IT-01/3D	-	-
0.7			-	IPD/MB-IN-01/3D	IPD/MB-IR-01/3D	-
1.5			IPD/MB-IT-03/3D	IPD/MB-IN-03/3D	IPD/MB-IR-03/3D	-
Cutting guide KIT		IPD/KT-IN-01	IPD/KT-IN-01	IPD/KT-IR-01	-	

Please see page 204 for the IPD Custom Interface System accessories.

IPDMILLED SYSTEM*

*Check availability

	Indication	Material	Diameter (mm)	ø3.3	ø3.8	ø4.25	ø5.0
TYPE A System (Compatible with DESS® Holders)		Ti	15	PR/MB-XT-15/A	PR/MB-XN-15/A	PR/MB-XR-15/A	PR/MB-XW-15/A

All premilled abutments include 2 titanium screws.

SCREWS

			ø3.3	ø3.8	ø4.25	ø5.0
IPD and OEM compatible	For straight channels	Torque value	25 Ncm	25 Ncm	25 Ncm	25 Ncm
Screwdriver	Coating	Seat				
1.27 Hex	-	Conical	IPD/MB-TN-00	IPD/MB-TN-00	IPD/MB-TR-00	IPD/MB-TR-00
1.27 Hex	TiN	Conical	IPD/MB-TN-00/TiN	IPD/MB-TN-00/TiN	IPD/MB-TR-00/TiN	IPD/MB-TR-00/TiN
1.27 Hex	BLC	Conical	IPD/MB-TN-00/BLC	IPD/MB-TN-00/BLC	IPD/MB-TR-00/BLC	IPD/MB-TR-00/BLC
	For ASC options	Torque value	25 Ncm	25 Ncm	25 Ncm	25 Ncm
Screwdriver	Coating	Seat				
TPA	TiN	Conical	IPD/MB-TN-50	IPD/MB-TN-50	IPD/MB-TR-50	IPD/MB-TR-50



[RETURN TO INDEX](#)

MULTI-UNIT ABUTMENT

Angulation	Indication	Gingival Height (mm)	ø3.3	ø3.8	ø4.25	ø5.0
0°		1.5	-	IPD/MB-MN-01	-	-
		3.0	-	IPD/MB-MN-03	-	-
		4.0	-	IPD/MB-MN-04	-	-

Straight Multi-unit abutments can be used for single and multiple restorations. Please see page 206 for the Multi-unit system accessories.



ANALOGS

Type		ø3.3	ø3.8	ø4.25	ø5.0
Standard		IPD/MB-AT-00	IPD/MB-AN-00	IPD/MB-AR-00	IPD/MB-AW-00
	Full set	IPD/MB-AT-90/3D	IPD/MB-AN-90/3D	IPD/MB-AR-90/3D	-
Digital	Analogue				
	Bottom Screw				
	Side Screw				



Co-Cr BASE ABUTMENT

		ø3.3	ø3.8	ø4.25	ø5.0	
Co-Cr Base for analogic workflow						
Indication	Angulation					
	0°	IPD/MB-BT-00	IPD/MB-BN-00	IPD/MB-BR-00	-	
	15°	IPD/MB-BT-10	IPD/MB-BN-10	IPD/MB-BR-10	-	
	25°	-	IPD/MB-BN-20	IPD/MB-BR-20	-	
	0°	IPD/MB-BT-01	IPD/MB-BN-01	IPD/MB-BR-01	-	
	15°	IPD/MB-BT-11	IPD/MB-BN-11	IPD/MB-BR-11	-	
	25°	-	IPD/MB-BN-21	IPD/MB-BR-21	-	
Co-Cr Base for digital workflow						
Indication	Angulation					
	Straight/ASC	IPD/MB-BT-00/3D	IPD/MB-BN-00/3D	IPD/MB-BR-00/3D	-	
		Straight/ASC	IPD/MB-BT-01/3D	IPD/MB-BN-01/3D	IPD/MB-BR-01/3D	-
Scan Body		IPD/SC-AN-B1	IPD/SC-AN-B1	IPD/SC-AN-B1	-	

All ASC CoCr analogic workflow abutments include the relevant TPA screw.



CASTABLE ABUTMENT

Indication		ø3.3	ø3.8	ø4.25	ø5.0
		-	IPD/MB-HN-00	IPD/MB-HR-00	IPD/MB-HW-00
		-	IPD/MB-RN-00	IPD/MB-RR-00	IPD/MB-RW-00



PSD OVERDENTURE ABUTMENT

Indication	Gingival Height (mm)	ø3.3	ø3.8	ø4.25	ø5.0
	1.0	IPD/MB-LT-01	IPD/MB-LN-01	IPD/MB-LR-01	-
	3.0	IPD/MB-LT-03	IPD/MB-LN-03	IPD/MB-LR-03	-
	5.0	-	IPD/MB-LN-05	IPD/MB-LR-05	-

Please see page 205 for the PSD system accessories.



TEMPORARY ABUTMENT / OPEN TRAY COPING

Indication	Gingival Height (mm)	ø3.3	ø3.8	ø4.25	ø5.0
	1.5	IPD/MB-PT-06	IPD/MB-PN-06	IPD/MB-PR-06	-
	1.5	IPD/MB-PT-07	IPD/MB-PN-07	IPD/MB-PR-07	-
Long coping screw		IPD/MB-TN-00/C	IPD/MB-TN-00/C	IPD/MB-TR-00/C	-

The same abutment can be used as a temporary abutment with the occlusal screw or as an impression coping using the coping screw.

HEALING ABUTMENT

Gingival Height (mm)	Head Diameter (mm)	ø3.3	ø3.8	ø4.25	ø5.0
2.0	-	-	IPD/MB-DN-02	IPD/MB-DR-02	-
3.0	-	-	IPD/MB-DN-03	IPD/MB-DR-03	-
4.0	-	-	IPD/MB-DN-04	IPD/MB-DR-04	-
6.0	-	-	IPD/MB-DN-06	IPD/MB-DR-06	-

SCREWDRIVERS

Type	Length (mm)	ø3.3	ø3.8	ø4.25	ø5.0
Implant system Screwdriver					
1.27 Hex	18	IPD/PH-27-18	IPD/PH-27-18	IPD/PH-27-18	IPD/PH-27-18
	25	IPD/PH-27-25	IPD/PH-27-25	IPD/PH-27-25	IPD/PH-27-25
	32	IPD/PH-27-32	IPD/PH-27-32	IPD/PH-27-32	IPD/PH-27-32
IPD Scan Body and extra Screwdrivers					
1.20 Hex	18	IPD/PH-20-18	IPD/PH-20-18	IPD/PH-20-18	IPD/PH-20-18
	25	IPD/PH-20-25	IPD/PH-20-25	IPD/PH-20-25	IPD/PH-20-25
	32	IPD/PH-20-32	IPD/PH-20-32	IPD/PH-20-32	IPD/PH-20-32
ASC Screwdriver					
TPA	18	IPD/KA-CT-18	IPD/KA-CT-18	IPD/KA-CT-18	IPD/KA-CT-18
	25	IPD/KA-CT-25	IPD/KA-CT-25	IPD/KA-CT-25	IPD/KA-CT-25
	32	IPD/KA-CT-32	IPD/KA-CT-32	IPD/KA-CT-32	IPD/KA-CT-32
PSD Screwdriver					
PSD	25	IPD/LL-PS-00	IPD/LL-PS-00	IPD/LL-PS-00	-

ACCESSORIES

Indication	Length (mm)	ø3.3	ø3.8	ø4.25	ø5.0
Clinical RA Shank Handle	16	IPD/MC-00-16	IPD/MC-00-16	IPD/MC-00-16	IPD/MC-00-16
Laboratory RA Shank Handle	70	IPD/ML-00-70	IPD/ML-00-70	IPD/ML-00-70	IPD/ML-00-70
RA Shank Ratchet	90	IPD/DI-00-90	IPD/DI-00-90	IPD/DI-00-90	IPD/DI-00-90
Ratchet adapter		IPD/DI-KA-90	IPD/DI-KA-90	IPD/DI-KA-90	IPD/DI-KA-90
PSD and insert extractor tool		IPD/LL-PS-01	IPD/LL-PS-01	IPD/LL-PS-01	-

Please see page 210 for more information.



PHIBO®

NA TSH® Prosthetic platform [S2 / S3-S4 / S5]

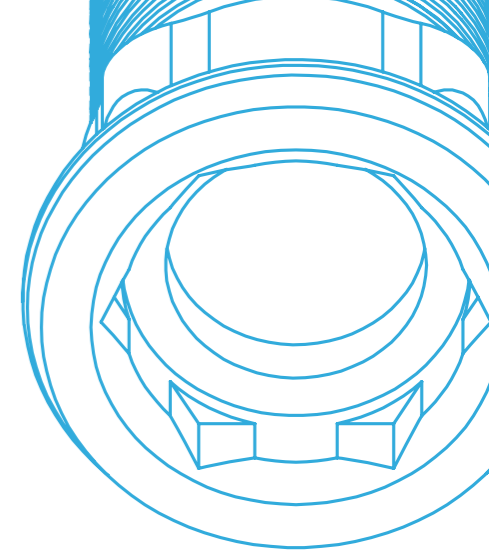

SCAN BODY

	Indication	Height (mm)	S2	S3-S4	S5
Scan Body		10	IPD/NA-SN-00	IPD/AA-SR-00	IPD/NA-SW-00
		15	IPD/NA-SN-02	IPD/AA-SR-02	-
		10	IPD/NA-SN-01	IPD/AA-SR-01	IPD/NA-SW-01

Captive screw included. 1.20 Hex Screwdriver.



Ti-BASE Custom Ti-Base System®

Indication	Gingival Height (mm)	S2	S3-S4	S5
	0.5	-	IPD/AA-IR-00/3D	-
	1.3	-	-	IPD/NA-IW-02/3D
	1.5	IPD/NA-IN-02/3D	IPD/AA-IR-02/3D	-
	2.5	-	IPD/AA-IR-04/3D	-
	Cutting guide KIT		IPD/KT-IN-00	IPD/KT-IR-00
	0.5	-	IPD/AA-IR-01/3D	-
	1.3	-	-	IPD/NA-IW-03/3D
	1.5	IPD/NA-IN-03/3D	IPD/AA-IR-03/3D	-
	2.5	-	IPD/AA-IR-05/3D	-
	Cutting guide KIT		IPD/KT-IN-01	IPD/KT-IR-01

Please see page 204 for the IPD Custom Interface System accessories.



IPDMILLED SYSTEM

*Check availability

Indication	Material	Diameter (mm)	S2	S3-S4	S5
TYPE A System (Compatible with DESS® Holders)					
	Ti	15	-	PR/AA-XR-15/A	-

All premilled abutments include 2 titanium screws.



RETURN TO INDEX

SCREWS

			S2	S3-S4	S5
IPD and OEM compatible	For straight channels	Torque value	35 Ncm	25 Ncm	35 Ncm
Screwdriver	Coating	Seat			
1.25 Hex	-	Conical	IPD/NA-TN-00	IPD/BA-TR-01	IPD/NA-TW-00
1.25 Hex	TiN	Conical	IPD/NA-TN-00/TiN	IPD/BA-TR-01/TiN	-
1.25 Hex	BLC	Conical	IPD/NA-TN-00/BLC	IPD/BA-TR-01/BLC	-
For ASC options			25 Ncm	25 Ncm	25 Ncm
Screwdriver	Coating	Seat			
TPA	TiN	Conical	IPD/MB-TN-50	IPD/AA-TR-50	IPD/MB-TR-50
Additional options				20 Ncm	20 Ncm
Screwdriver	Coating	Seat			
1.20 Hex	-	Low profile head - conical seat	-	IPD/AA-TR-01	IPD/AA-TR-01
1.20 Hex	TiN	Low profile head - conical seat	-	IPD/AA-TR-01/TiN	IPD/AA-TR-01/TiN
1.20 Hex	BLC	Low profile head - conical seat	-	IPD/AA-TR-01/BLC	IPD/AA-TR-01/BLC
For ASC options				25 Ncm	25 Ncm
Screwdriver	Coating	Seat			
TPA	TiN	For implant level flat seat	-	IPD/AA-TR-52	IPD/AA-TR-52



MULTI-UNIT ABUTMENT

Angulation	Indication	Gingival Height (mm)	S2	S3-S4	S5
0°		1.0	-	IPD/AB-MR-01	-
		2.0	-	IPD/AB-MR-02	-
		3.0	-	IPD/AB-MR-03	-
		4.0	-	IPD/AB-MR-04	-
		5.0	-	IPD/AB-MR-05	-
17°		2.0	-	IPD/AB-MR-12	-
		3.0	-	IPD/AB-MR-13	-
		4.0	-	IPD/AB-MR-14	-
30°		3.0	-	IPD/AB-MR-33	-
		4.0	-	IPD/AB-MR-34	-
		5.0	-	IPD/AB-MR-35	-
		Replacement Screw for Angled MUA	-	IPD/KA-MT-00	-

Straight Multi-unit abutments can be used for single and multiple restorations. Please see page ___ for the MMulti-unit system accessories.



ANALOGS

Type	S2	S3-S4	S5
Standard	IPD/NA-AN-00	IPD/AA-AR-00	IPD/HA-AW-00
	Full set	IPD/NA-AN-90/3D	IPD/AA-AR-90/3D
Digital		Analogs	
		Bottom Screw	
		Side Screw	



Co-Cr BASE ABUTMENT

		S2	S3-S4	S5
Co-Cr Base for analogic workflow				
Indication	Angulation			
	0°	-	IPD/AA-BR-00	-
	15°	-	IPD/AA-BR-10	-
	25°	-	IPD/AA-BR-20	-
	0°	-	IPD/AA-BR-01	-
	15°	-	IPD/AA-BR-11	-
	25°	-	IPD/AA-BR-21	-
Co-Cr Base for digital workflow				
Indication	Angulation			
	Straight/ASC	-	IPD/AA-BR-00/3D	-
	Straight/ASC	-	IPD/AA-BR-01/3D	-
Scan Body		-	IPD/SC-AN-B1	-

All ASC CoCr analogic workflow abutments include the relevant TPA screw.



CASTABLE ABUTMENT

Indication	S2	S3-S4	S5
	IPD/NA-HN-00	IPD/AA-HR-00	IPD/HA-HW-00
	IPD/NA-RN-00	IPD/AA-RR-00	IPD/HA-RW-00



PSD OVERDENTURE ABUTMENT

Indication	Gingival Height (mm)	S2	S3-S4	S5
	1.0	IPD/NA-LN-01	IPD/AA-LR-01	-
	2.0	-	IPD/AA-LR-02	-
	3.0	IPD/NA-LN-03	IPD/AA-LR-03	-
	4.0	-	IPD/AA-LR-04	-
	5.0	IPD/NA-LN-05	IPD/AA-LR-05	-

Please see page 205 for the PSD system accessories.



COPING ABUTMENT

Type	S2	S3-S4	S5
Open tray	-	IPD/AA-CR-00	-
Closed tray	-	IPD/AA-CR-01	-
Classic Design			



TEMPORARY ABUTMENT / OPEN TRAY COPING

Indication	Gingival Height (mm)	S2	S3-S4	S5
	1.5	IPD/NA-PN-06	IPD/AA-PR-06	IPD/NA-PW-06
	1.5	IPD/NA-PN-07	IPD/AA-PR-07	IPD/NA-PW-07
Long coping screw		IPD/NA-TN-00/C	IPD/AA-TR-00/C	IPD/NA-TW-00/C

The same abutment can be used as a temporary abutment with the occlusal screw or as an impression coping using the coping screw.



HEALING ABUTMENT

Gingival Height (mm)		S2	S3-S4	S5
	Head Diameter (mm)	ø3.8	ø4.7	ø5.5
2.0		-	IPD/AA-DR-02	-
3.0		IPD/NA-DN-03	IPD/AA-DR-03	IPD/NA-DW-03
4.0		IPD/NA-DN-04	IPD/AA-DR-04	-
5.0		IPD/NA-DN-05	IPD/AA-DR-05	IPD/NA-DW-05



TI CEMENT-RETAINED ABUTMENT

Indication	Angulation	Gingival Height	S2	S3-S4	S5
☺	0°	2.0	-	IPD/AA-PR-00	-
	15°	1.0	-	IPD/AA-PR-02	-
		2.0	-	IPD/AA-PR-04	-
	25°	1.0	-	IPD/AA-PR-03	-
2.0		-	IPD/AA-PR-05	-	
☺☺☺	0°	2.0	-	IPD/AA-PR-01	-

Using the Low profile IPD/AA-TR-01 screw for IPD/AA-PR-04 is recommended



SCREWDRIVERS

Type	Length (mm)	S2	S3-S4	S5
Implant system Screwdriver				
1.25 Hex	18	IPD/PH-25-18	IPD/PH-25-18	IPD/PH-25-18
	25	IPD/PH-25-25	IPD/PH-25-25	IPD/PH-25-25
	32	IPD/PH-25-32	IPD/PH-25-32	IPD/PH-25-32
IPD Scan Body and extra Screwdrivers				
1.20 Hex	18	IPD/PH-20-18	IPD/PH-20-18	IPD/PH-20-18
	25	IPD/PH-20-25	IPD/PH-20-25	IPD/PH-20-25
	32	IPD/PH-20-32	IPD/PH-20-32	IPD/PH-20-32
ASC Screwdriver				
TPA	18	IPD/KA-CT-18	IPD/KA-CT-18	IPD/KA-CT-18
	25	IPD/KA-CT-25	IPD/KA-CT-25	IPD/KA-CT-25
	32	IPD/KA-CT-32	IPD/KA-CT-32	IPD/KA-CT-32
PSD Screwdriver				
PSD	25	IPD/LL-PS-00	IPD/LL-PS-00	-



ACCESSORIES

Indication	Length (mm)	S2	S3-S4	S5
Clinical RA Shank Handle	16	IPD/MC-00-16	IPD/MC-00-16	IPD/MC-00-16
Laboratory RA Shank Handle	70	IPD/ML-00-70	IPD/ML-00-70	IPD/ML-00-70
RA Shank Ratchet	90	IPD/DI-00-90	IPD/DI-00-90	IPD/DI-00-90
Ratchet adapter		IPD/DI-KA-90	IPD/DI-KA-90	IPD/DI-KA-90
PSD and insert extractor tool		IPD/LL-PS-01	IPD/LL-PS-01	-

Please see page 210 for more information.



OSSTEM IMPLANT®

OB TSIII Prosthetic platform [M ø3.5 / R ø4.0]

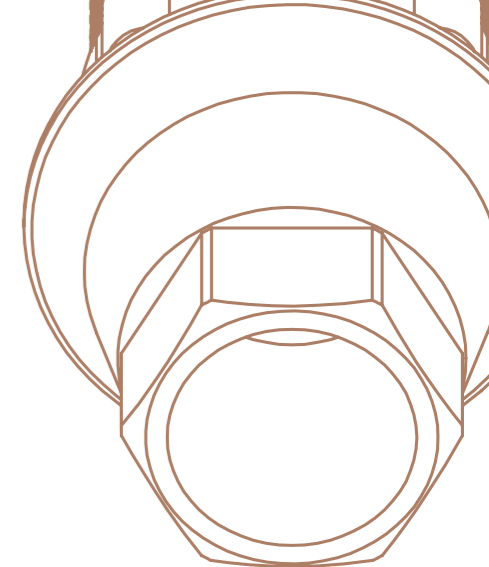

SCAN BODY

	Indication	Height (mm)	M ø3.5	R ø4.0
Scan Body	☺	10	IPD/OB-SN-00	IPD/OB-SR-00
		15	IPD/OB-SN-02	IPD/OB-SR-02
	☺☺☺	10	IPD/OB-SN-01	IPD/OB-SR-01

Captive screw included. 1.20 Hex Screwdriver.



Ti-BASE *ipd* Custom Ti-Base System®

Indication	Gingival Height (mm)	M ø3.5	R ø4.0
☺	1.0	IPD/OB-IN-00/3D	IPD/OB-IR-00/3D
	2.0	IPD/OB-IN-02/3D	IPD/OB-IR-02/3D
	3.0	IPD/OB-IN-04/3D	IPD/OB-IR-04/3D
Cutting guide KIT		IPD/KT-IN-00	IPD/KT-IR-00
☺☺☺	1.0	IPD/OB-IN-01/3D	IPD/OB-IR-01/3D
	2.0	IPD/OB-IN-03/3D	IPD/OB-IR-03/3D
	3.0	IPD/OB-IN-05/3D	IPD/OB-IR-05/3D
Cutting guide KIT		IPD/KT-IN-01	IPD/KT-IR-01

Please see page 204 for the IPD Custom Interface System accessories.



IPDMILLED SYSTEM* **NEW**

*Check availability

Indication	Material	Diameter (mm)	M ø3.5	R ø4.0
IPD Blank System (Compatible with NT/IPD Holders)				
	Ti	12	IPD/OB-XN-00	IPD/OB-XR-00
Mill Analog			IPD/OB-AN-00/X	IPD/OB-AR-00/X
TYPE A System (Compatible with DESS® Holders)				
	Ti	10	PR/OB-XN-10/A	PR/OB-XR-10/A
	Ti	15	PR/OB-XN-15/A	PR/OB-XR-15/A

All premilled abutments include 2 titanium screws.



SCREWS

			M ø3.5	R ø4.0
IPD compatible	For straight channels	Torque value	20 Ncm	30 Ncm
Screwdriver	Coating	Seat		
1.20 Hex	-	Conical	IPD/OB-TN-00	IPD/OB-TR-00
1.20 Hex	TiN	Conical	IPD/OB-TN-00/TiN	IPD/OB-TR-00/TiN
1.20 Hex	BLC	Conical	IPD/OB-TN-00/BLC	IPD/OB-TR-00/BLC
	For ASC options	Torque value	20 Ncm	25 Ncm
Screwdriver	Coating	Seat		
TPA	TiN	Conical	IPD/OB-TN-50	IPD/OB-TR-50



RETURN TO INDEX

MULTI-UNIT ABUTMENT

Angulation	Indication	Gingival Height (mm)	M ϕ 3.5	R ϕ 4.0
0°		1.5	IPD/OB-MN-01	IPD/OB-MR-01
		2.5	IPD/OB-MN-02	IPD/OB-MR-02
		3.5	IPD/OB-MN-03	IPD/OB-MR-03
		4.5	IPD/OB-MN-04	IPD/OB-MR-04
		5.5	IPD/OB-MN-05	IPD/OB-MR-05
17°		2.5	IPD/OB-MN-12	IPD/OB-MR-12
		3.5	IPD/OB-MN-13	IPD/OB-MR-13
30°		3.5	IPD/OB-MN-33	IPD/OB-MR-33
		4.5	IPD/OB-MN-34	IPD/OB-MR-34
Replacement Screw for Angled MUA			IPD/KA-MT-09	IPD/KA-MT-03

Straight Multi-unit abutments can be used for single and multiple restorations. Please see page 206 for the Multi-unit system accessories.



MULTI-UNIT AP ABUTMENT* NEW

*Check availability

Angulation	Indication	Gingival Height (mm)	M ϕ 3.5	R ϕ 4.0
17°		2.5	IPD/OB-MN-12/AP	IPD/OB-MR-12/AP
		3.5	IPD/OB-MN-13/AP	IPD/OB-MR-13/AP
30°		3.5	IPD/OB-MN-33/AP	IPD/OB-MR-33/AP
		4.5	IPD/OB-MN-34/AP	IPD/OB-MR-34/AP
Replacement Screw for Angled MUA AP			IPD/KA-MT-09/BLC	IPD/KA-MT-03/BLC

Please see page 206 for the Multi-unit system accessories.



ANALOGS

Type	M ϕ 3.5	R ϕ 4.0
Standard	IPD/OB-AN-00	IPD/OB-AR-00
	Full set	IPD/OB-AN-90/3D
Digital		Analog
		Bottom Screw
		Side Screw



Co-Cr BASE ABUTMENT

Indication	Angulation	M ϕ 3.5	R ϕ 4.0
Co-Cr Base for analogic workflow			
	0°	IPD/OB-BN-00	IPD/OB-BR-00
	15°	IPD/OB-BN-10	IPD/OB-BR-10
	0°	IPD/OB-BN-01	IPD/OB-BR-01
	15°	IPD/OB-BN-11	IPD/OB-BR-11
Co-Cr Base for digital workflow			
	Straight/ASC	IPD/OB-BN-00/3D	IPD/OB-BR-00/3D
	Straight/ASC	IPD/OB-BN-01/3D	IPD/OB-BR-01/3D
Scan Body		IPD/SC-AN-B1	IPD/SC-AN-B1

All ASC CoCr analogic workflow abutments include the relevant TPA screw.



PSD OVERDENTURE ABUTMENT

Indication	Gingival Height (mm)	M ϕ 3.5	R ϕ 4.0
	1.0	IPD/OB-LN-01	IPD/OB-LR-01
	2.0	IPD/OB-LN-02	IPD/OB-LR-02
	3.0	IPD/OB-LN-03	IPD/OB-LR-03
	4.0	IPD/OB-LN-04	IPD/OB-LR-04
	5.0	IPD/OB-LN-05	IPD/OB-LR-05

Please see page 205 for the PSD system accessories.



TEMPORARY ABUTMENT / OPEN TRAY COPING

Indication	Gingival Height (mm)	M ϕ 3.5	R ϕ 4.0
	1.5	IPD/OB-PN-06	IPD/OB-PR-06
	1.5	IPD/OB-PN-07	IPD/OB-PR-07
Long coping screw		IPD/OB-TN-00/C	IPD/OB-TR-00/C

The same abutment can be used as a temporary abutment with the occlusal screw or as an impression coping using the coping screw.



HEALING ABUTMENT

Gingival Height (mm)	Head Diameter (mm)	M ϕ 3.5	R ϕ 4.0
	ϕ 4.0		ϕ 4.5
3.0		IPD/OB-DN-03	IPD/OB-DR-03
5.0		IPD/OB-DN-05	IPD/OB-DR-05
7.0		IPD/OB-DN-07	IPD/OB-DR-07



SCREWDRIVERS

Type	Length (mm)	M ϕ 3.5	R ϕ 4.0
Implant system Screwdriver			
IPD Scan Body and extra Screwdrivers			
1.20 Hex	18	IPD/PH-20-18	IPD/PH-20-18
	25	IPD/PH-20-25	IPD/PH-20-25
	32	IPD/PH-20-32	IPD/PH-20-32
ASC Screwdriver			
TPA	18	IPD/KA-CT-18	IPD/KA-CT-18
	25	IPD/KA-CT-25	IPD/KA-CT-25
	32	IPD/KA-CT-32	IPD/KA-CT-32
PSD Screwdriver			
PSD	25	IPD/LL-PS-00	IPD/LL-PS-00



ACCESSORIES

Indication	Length (mm)	M ϕ 3.5	R ϕ 4.0
Clinical RA Shank Handle	16	IPD/MC-00-16	IPD/MC-00-16
Laboratory RA Shank Handle	70	IPD/ML-00-70	IPD/ML-00-70
RA Shank Ratchet	90	IPD/DI-00-90	IPD/DI-00-90
Ratchet adapter		IPD/DI-KA-90	IPD/DI-KA-90
PSD and insert extractor tool		IPD/LL-PS-01	IPD/LL-PS-01

Please see page 210 for more information.



BIOTECH® DENTAL

QB KONTACT® Prosthetic platform [RP]

*Biotech® Dental is the exclusive distributor of this product in France.

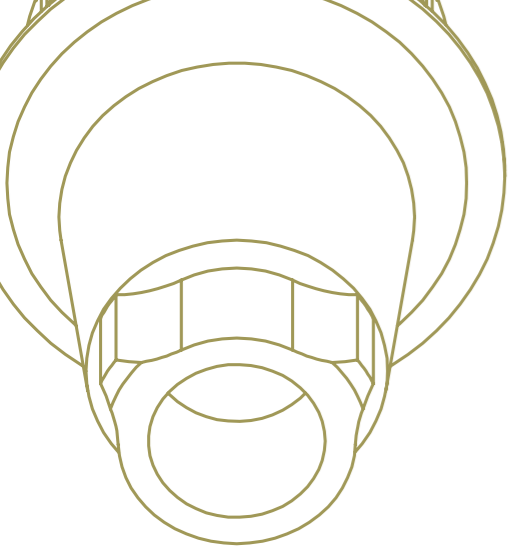

SCAN BODY

	Indication	Height (mm)	RP ●
Scan Body		10	IPD/QB-SR-00
		15	IPD/QB-SR-02
		10	IPD/QB-SR-01

Captive screw included. 1.20 Hex Screwdriver.

Ti-BASE Custom Ti-Base System®

Indication	Gingival Height (mm)	RP ●
	1.0	IPD/QB-IR-00/3D
	2.0	IPD/QB-IR-02/3D
	3.0	IPD/QB-IR-04/3D
	Cutting guide KIT	IPD/KT-IR-00
	1.0	IPD/QB-IR-01/3D
	2.0	IPD/QB-IR-03/3D
	3.0	IPD/QB-IR-05/3D
	Cutting guide KIT	IPD/KT-IR-01

Please see page 204 for the IPD Custom Interface System accessories.

IPDMILLED SYSTEM*

*Check availability

Indication	Material	Diameter (mm)	RP ●
TYPE A System (Compatible with DESS® Holders)			
	Ti	15	PR/QB-XR-15/A

All premilled abutments include 2 titanium screws.

SCREWS

			RP ●
IPD and OEM compatible	For straight channels	Torque value	20 Ncm
Screwdriver	Coating	Seat	
1.20 Hex	-	Conical	IPD/QB-TR-00
1.20 Hex	TiN	Conical	IPD/QB-TR-00/TiN
1.20 Hex	BLC	Conical	IPD/QB-TR-00/BLC
	For ASC options	Torque value	15 Ncm
Screwdriver	Coating	Seat	
TPA	TiN	Conical	IPD/QB-TR-50
Removing tool		Conical	IPD/QB-TR-01



[RETURN TO INDEX](#)

MULTI-UNIT ABUTMENT

Angulation	Indication	Gingival Height (mm)	RP ●
0°		1.5	IPD/QB-MR-01
		2.5	IPD/QB-MR-02
		3.5	IPD/QB-MR-03
17°		3.5	IPD/QB-MR-13
30°		4.5	IPD/QB-MR-34
	Replacement Screw for Angled MUA		IPD/KA-MT-12

Straight Multi-unit abutments can be used for single and multiple restorations. Please see page 206 for the Multi-unit system accessories.



ANALOGS

Type	RP ●
Standard	IPD/QB-AR-00
	Full set
	IPD/QB-AR-90/3D
Digital	Analog
	Bottom Screw
	Side Screw



Co-Cr BASE ABUTMENT

		RP ●
Co-Cr Base for analogic workflow		
Indication	Angulation	
	0°	IPD/QB-BR-00
	15°	IPD/QB-BR-10
	0°	IPD/QB-BR-01
	15°	IPD/QB-BR-11
Co-Cr Base for digital workflow		
Indication	Angulation	
	Straight/ASC	IPD/QB-BR-00/3D
	Straight/ASC	IPD/QB-BR-01/3D
	Scan Body	IPD/SC-AN-B1

All ASC CoCr analogic workflow abutments include the relevant TPA screw.



PSD OVERDENTURE ABUTMENT

Indication	Gingival Height (mm)	RP ●
	2.0	IPD/QB-LR-02
	3.0	IPD/QB-LR-03
	4.0	IPD/QB-LR-04

Please see page 205 for the PSD system accessories.



TEMPORARY ABUTMENT / OPEN TRAY COPING

Indication	Gingival Height (mm)	RP ●
	1.5	IPD/QB-PR-06
	1.5	IPD/QB-PR-07
	Long coping screw	IPD/QB-TR-00/C

The same abutment can be used as a temporary abutment with the occlusal screw or as an impression coping using the coping screw.



HEALING ABUTMENT

Gingival Height (mm)	Head Diameter (mm)	RP
1.5	φ4.5	IPD/QB-DR-01
3.0		IPD/QB-DR-03
5.0		IPD/QB-DR-05



SCREWDRIVERS

Type	Length (mm)	RP
Implant system Screwdriver		
IPD Scan Body and extra Screwdrivers		
1.20 Hex	18	IPD/PH-20-18
	25	IPD/PH-20-25
	32	IPD/PH-20-32
ASC Screwdriver		
TPA	18	IPD/KA-CT-18
	25	IPD/KA-CT-25
	32	IPD/KA-CT-32
PSD Screwdriver		
PSD	25	IPD/LL-PS-00



ACCESSORIES

Indication	Length (mm)	RP
Clinical RA Shank Handle	16	IPD/MC-00-16
Laboratory RA Shank Handle	70	IPD/ML-00-70
RA Shank Ratchet	90	IPD/DI-00-90
Ratchet adapter	-	IPD/DI-KA-90
PSD and insert extractor	-	IPD/LL-PS-01



Please see page 210 for more information.

NEODENT®

RA HELIX® HE

Prosthetic platform [φ3.3 / φ4.1 / φ5.0]

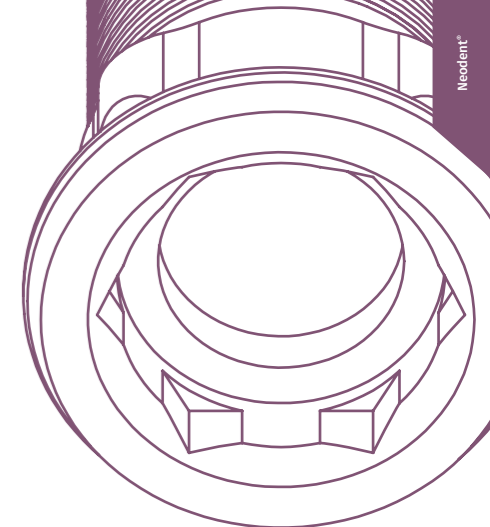

SCAN BODY

	Indication	Height (mm)	φ3.3	φ4.1	φ5.0
Scan Body	[Single tooth]	10	IPD/RA-SN-00	IPD/AA-SR-00	IPD/RA-SW-00
		15	IPD/RA-SN-02	IPD/AA-SR-02	IPD/RA-SW-02
	[Full arch]	10	IPD/RA-SN-01	IPD/AA-SR-01	IPD/RA-SW-01

Captive screw included. 1.20 Hex Screwdriver.



Ti-BASE ipd Custom Ti-Base System®

Indication	Gingival Height (mm)	φ3.3	φ4.1	φ5.0
[Single tooth]	0.5	-	IPD/AA-IR-00/3D	-
	1.3	IPD/RA-IN-02/3D	-	-
	1.4	-	-	IPD/RA-IW-02/3D
	1.5	-	IPD/AA-IR-02/3D	-
	2.5	IPD/RA-IN-04/3D	IPD/AA-IR-04/3D	-
Cutting guide KIT		IPD/KT-IN-00	IPD/KT-IR-00	IPD/KT-IW-00
[Full arch]	0.5	-	IPD/AA-IR-01/3D	-
	1.3	IPD/RA-IN-03/3D	-	IPD/RA-IW-03/3D*
	1.5	-	IPD/AA-IR-03/3D	-
	2.5	IPD/RA-IN-05/3D	IPD/AA-IR-05/3D	-
	Cutting guide KIT		IPD/KT-IN-01	IPD/KT-IR-01

Please see page 204 for the IPD Custom Interface System accessories.

*Only available Post Height 3.5 mm version



IPDMILLED SYSTEM* NEW

*Check availability

Indication	Material	Diameter (mm)	φ3.3	φ4.1	φ5.0
TYPE A System (Compatible with DESS® Holders)	Ti	15	-	PR/AA-XR-15/A	-

All premilled abutments include 2 titanium screws.



RETURN TO INDEX

SCREWS

			Ø3.3	Ø4.1	Ø5.0
IPD and OEM compatible	For straight channels	Torque value	32 Ncm	25 Ncm	32 Ncm
Screwdriver	Coating	Seat			
1.20 Hex	-	Flat	IPD/RA-TN-00	-	IPD/RA-TW-00
1.20 Hex	TiN	Flat	IPD/RA-TN-00/TiN	-	IPD/RA-TW-00/TiN
1.20 Hex	BLC	Flat	IPD/RA-TN-00/BLC	-	IPD/RA-TW-00/BLC
1.20 Hex	-	Conical	-	IPD/BA-TR-00	-
1.20 Hex	TiN	Conical	-	IPD/BA-TR-00/TiN	-
1.20 Hex	BLC	Conical	-	IPD/BA-TR-00/BLC	-
			25 Ncm	25 Ncm	25 Ncm
Screwdriver	Coating	Seat			
TPA	TiN	Conical	IPD/RA-TN-50	IPD/AA-TR-50	IPD/RA-TW-50
			20 Ncm		
Additional options		Torque value			
Screwdriver	Seat				
1.20 Hex	-	Low profile head - conical seat	-	IPD/AA-TR-01	-
1.20 Hex	TiN	Low profile head - conical seat	-	IPD/AA-TR-01/TiN	-
1.20 Hex	BLC	Low profile head - conical seat	-	IPD/AA-TR-01/BLC	-
			35 Ncm		
Screwdriver	Seat				
Unigrip	-	Conical	-	IPD/AA-TR-00	-
Unigrip	TiN	Conical	-	IPD/AA-TR-00/TiN	-
Unigrip	BLC	Conical	-	IPD/AA-TR-00/BLC	-
			35 Ncm		
Screwdriver	Seat				
Unigrip	-	For implant level flat seat	-	IPD/AA-TR-02	-
Unigrip	TiN	For implant level flat seat	-	IPD/AA-TR-02/TiN	-
Unigrip	BLC	For implant level flat seat	-	IPD/AA-TR-02/BLC	-
			25 Ncm		
Screwdriver	Coating	Seat			
TPA	TiN	For implant level flat seat	-	IPD/AA-TR-52	-



MULTI-UNIT ABUTMENT

Angulation	Indication	Gingival Height (mm)	Ø3.3	Ø4.1	Ø5.0
0°		1.0	-	IPD/AB-MR-01	-
		1.5	IPD/RA-MN-01	-	IPD/RA-MW-01
		2.0	-	IPD/AB-MR-02	-
		2.5	IPD/RA-MN-02	-	IPD/RA-MW-02
		3.0	-	IPD/AB-MR-03	-
		3.5	IPD/RA-MN-03	-	IPD/RA-MW-03
17°		2.0	-	IPD/AB-MR-04	-
		3.0	-	IPD/AB-MR-05	-
		4.0	-	IPD/AB-MR-12	-
		5.0	-	IPD/AB-MR-13	-
30°		3.0	-	IPD/AB-MR-14	-
		4.0	-	IPD/AB-MR-33	-
		4.0	-	IPD/AB-MR-34	-
		5.0	-	IPD/AB-MR-35	-
	Replacement Screw for Angled MUA		-	IPD/KA-MT-00	-



Straight Multi-unit abutments can be used for single and multiple restorations
Please see page 206 for the Multi-unit system accessories.

ANALOGS

Type		Ø3.3	Ø4.1	Ø5.0
Standard		IPD/RA-AN-00	IPD/AA-AR-00	IPD/RA-AW-00
	Full set	IPD/RA-AN-90/3D	IPD/AA-AR-90/3D	IPD/RA-AW-90/3D
Digital	Analog			
	Bottom Screw			
	Side Screw			



Co-Cr BASE ABUTMENT

		Ø3.3	Ø4.1	Ø5.0
Co-Cr Base for analogic workflow				
Indication	Angulation			
	0°	IPD/RA-BN-00	IPD/AA-BR-00	IPD/RA-BW-00
	15°	IPD/RA-BN-10	IPD/AA-BR-10	-
	25°	-	IPD/AA-BR-20	-
	0°	IPD/RA-BN-01	IPD/AA-BR-01	IPD/RA-BW-01
	15°	IPD/RA-BN-11	IPD/AA-BR-11	-
	25°	-	IPD/AA-BR-21	-
Co-Cr Base for digital workflow				
Indication	Angulation			
	Straight/ASC	IPD/RA-BN-00/3D	IPD/AA-BR-00/3D	IPD/RA-BW-00/3D
	Straight/ASC	IPD/RA-BN-01/3D	IPD/AA-BR-01/3D	IPD/RA-BW-01/3D
		Scan Body	IPD/SC-AN-B1	IPD/SC-AN-B1



All ASC CoCr analogic workflow abutments include the relevant TPA screw.

CASTABLE ABUTMENT

Indication	Ø3.3	Ø4.1	Ø5.0
	-	IPD/AA-HR-00	-
	-	IPD/AA-RR-00	-



PSD OVERDENTURE ABUTMENT

Indication	Gingival Height (mm)	Ø3.3	Ø4.1	Ø5.0
	1.0	-	IPD/AA-LR-01	-
	2.0	IPD/RA-LN-02	IPD/AA-LR-02	IPD/RA-LW-02
	3.0	IPD/RA-LN-03	IPD/AA-LR-03	IPD/RA-LW-03
	4.0	IPD/RA-LN-04	IPD/AA-LR-04	IPD/RA-LW-04
	5.0	-	IPD/AA-LR-05	-



Please see page 205 for the PSD system accessories.

COPING ABUTMENT

Type	Ø3.3	Ø4.1	Ø5.0
Open tray	-	IPD/AA-CR-00	-
Closed tray	-	IPD/AA-CR-01	-



TEMPORARY ABUTMENT / OPEN TRAY COPING

Indication	Gingival Height (mm)	Ø3.3	Ø4.1	Ø5.0
	1.5	IPD/RA-PN-06	IPD/AA-PR-06	IPD/RA-PW-06
	1.5	IPD/RA-PN-07	IPD/AA-PR-07	IPD/RA-PW-07
		Long coping screw	IPD/RA-TN-00/C	IPD/AA-TR-00/C

The same abutment can be used as a temporary abutment with the occlusal screw or as an impression coping using the coping screw.



HEALING ABUTMENT

Gingival Height (mm)	Head Diameter (mm)	Ø3.3	Ø4.1	Ø5.0
2.0		IPD/RA-DN-02	IPD/AA-DR-02	IPD/RA-DW-02
3.0		IPD/RA-DN-03	IPD/AA-DR-03	IPD/RA-DW-03
4.0		IPD/RA-DN-04	IPD/AA-DR-04	IPD/RA-DW-04
5.0		-	IPD/AA-DR-05	-



TI CEMENT-RETAINED ABUTMENT

Indication	Angulation	Gingival Height	Ø3.3	Ø4.1	Ø5.0
	0°	2.0	-	IPD/AA-PR-00	-
	15°	1.0	-	IPD/AA-PR-02	-
	25°	1.0	-	IPD/AA-PR-03	-
	0°	2.0	-	IPD/AA-PR-05	-
	0°	2.0	-	IPD/AA-PR-01	-

Using the Low profile IPD/AA-TR-01 screw for IPD/AA-PR-04 is recommended



SCREWDRIVERS

Type	Length (mm)	Ø3.3	Ø4.1	Ø5.0
Implant system Screwdriver				
IPD Scan Body and extra Screwdrivers				
	18	IPD/PH-20-18	IPD/PH-20-18	IPD/PH-20-18
1.20 Hex	25	IPD/PH-20-25	IPD/PH-20-25	IPD/PH-20-25
	32	IPD/PH-20-32	IPD/PH-20-32	IPD/PH-20-32
ASC Screwdriver				
	18	IPD/KA-CT-18	IPD/KA-CT-18	IPD/KA-CT-18
TPA	25	IPD/KA-CT-25	IPD/KA-CT-25	IPD/KA-CT-25
	32	IPD/KA-CT-32	IPD/KA-CT-32	IPD/KA-CT-32
PSD Screwdriver				
PSD	25	IPD/LL-PS-00	IPD/LL-PS-00	IPD/LL-PS-00



ACCESSORIES

Indication	Length (mm)	Ø3.3	Ø4.1	Ø5.0
Clinical RA Shank Handle	16	IPD/MC-00-16	IPD/MC-00-16	IPD/MC-00-16
Laboratory RA Shank Handle	70	IPD/ML-00-70	IPD/ML-00-70	IPD/ML-00-70
RA Shank Ratchet	90	IPD/DI-00-90	IPD/DI-00-90	IPD/DI-00-90
Ratchet adapter		IPD/DI-KA-90	IPD/DI-KA-90	IPD/DI-KA-90
PSD and insert extractor tool		IPD/LL-PS-01	IPD/LL-PS-01	IPD/LL-PS-01

Please see page 210 for more information.



NEODENT®

RB GRAND MORSE™ GM Prosthetic platform [GM]

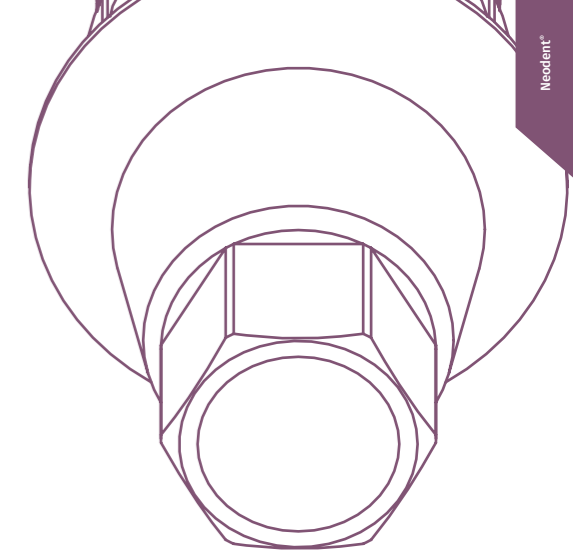

SCAN BODY

Indication	Height (mm)	GM
	10	IPD/RB-SR-00
	15	IPD/RB-SR-02
	10	IPD/RB-SR-01

Captive screw included. 1.20 Hex Screwdriver.



Ti-BASE Custom Ti-Base System®

Indication	Gingival Height (mm)	GM
	1.0	IPD/RB-IR-00/3D
	2.0	IPD/RB-IR-02/3D
	3.0	IPD/RB-IR-04/3D
	4.0	IPD/RB-IR-06/3D
	Cutting guide KIT	IPD/KT-IR-00
	1.0	IPD/RB-IR-01/3D
	2.0	IPD/RB-IR-03/3D
	3.0	IPD/RB-IR-05/3D
	4.0	IPD/RB-IR-07/3D
	Cutting guide KIT	IPD/KT-IR-01



Please see page 204 for the IPD Custom Interface System accessories.

IPDMILLED SYSTEM*

*Check availability

Indication	Material	Diameter (mm)	GM
IPD Blank System (Compatible with NT/IPD Holders)			
	Ti	12	IPD/RB-XR-00
Mill Analog			IPD/RB-AR-00/X
TYPE A System (Compatible with DESS® Holders)			
	Ti	15	PR/RB-XR-15/A

All premilled abutments include 2 titanium screws.



SCREWS

IPD and OEM compatible	For straight channels	Torque value	GM
		20 Ncm	
Screwdriver			
	Coating	Seat	
Neo GM	-	Conical	IPD/RB-TR-00
Neo GM	TiN	Conical	IPD/RB-TR-00/TiN
Neo GM	BLC	Conical	IPD/RB-TR-00/BLC
For ASC options			
		Torque value	20 Ncm
Screwdriver			
	Coating	Seat	
TPA	TiN	Conical	IPD/RB-TR-50



[RETURN TO INDEX](#)

MULTI-UNIT ABUTMENT

Angulation	Indication	Gingival Height (mm)	GM
0°		1.5	IPD/RB-MR-01
		2.5	IPD/RB-MR-02
		3.5	IPD/RB-MR-03
		4.5	IPD/RB-MR-04
17°		2.5	IPD/RB-MR-12
30°		3.5	IPD/RB-MR-33
Replacement Screw for Angled MUA			IPD/KA-MT-02

Straight Multi-unit abutments can be used for single and multiple restorations. Please see page 206 for the Multi-unit system accessories.

MULTI-UNIT AP ABUTMENT* NEW

*Check availability

Angulation	Indication	Gingival Height (mm)	GM
17°		2.5	IPD/RB-MR-12/AP
		3.5	IPD/RB-MR-13/AP
30°		3.5	IPD/RB-MR-33/AP
		4.5	IPD/RB-MR-34/AP
Replacement Screw for Angled MUA AP			IPD/KA-MT-02/BLC

Please see page 206 for the Multi-unit system accessories.

ANALOGS

Type	GM
Standard	IPD/RB-AR-00
Full set	IPD/RB-AR-90/3D
Digital	<ul style="list-style-type: none"> Analogue Bottom Screw Side Screw

Co-Cr BASE ABUTMENT

		GM
Co-Cr Base for analogic workflow		
Indication	Angulation	
	0°	IPD/RB-BR-00
		IPD/RB-BR-01
Co-Cr Base for digital workflow		
Indication	Angulation	
	Straight/ASC	IPD/RB-BR-00/3D
		IPD/RB-BR-01/3D
Scan Body		IPD/SC-AN-B1



PSD OVERDENTURE ABUTMENT

Indication	Gingival Height (mm)	GM
	2.0	IPD/RB-LR-02
	3.0	IPD/RB-LR-03
	4.0	IPD/RB-LR-04
	5.0	IPD/RB-LR-05

Please see page 205 for the PSD system accessories.

TEMPORARY ABUTMENT / OPEN TRAY COPING

Indication	Gingival Height (mm)	GM
	1.5	IPD/RB-PR-06
	1.5	IPD/RB-PR-07
Long coping screw		IPD/RB-TR-00/C

The same abutment can be used as a temporary abutment with the occlusal screw or as an impression coping using the coping screw.

HEALING ABUTMENT

Gingival Height (mm)	Head Diameter (mm)	GM
1.5	ø4,5	IPD/RB-DR-01
3.0		IPD/RB-DR-03
5.0		IPD/RB-DR-05
7.0		IPD/RB-DR-07

SCREWDRIVERS

Type	Length (mm)	GM
Implant system Screwdriver		
	18	IPD/PU-01-18
Neo GM	25	IPD/PU-01-25
	32	IPD/PU-01-32
IPD Scan Body and extra Screwdrivers		
	18	IPD/PH-20-18
1.20 Hex	25	IPD/PH-20-25
	32	IPD/PH-20-32
ASC Screwdriver		
TPA	18	IPD/KA-CT-18
	25	IPD/KA-CT-25
	32	IPD/KA-CT-32
PSD Screwdriver		
PSD	25	IPD/LL-PS-00

ACCESSORIES

Indication	Length (mm)	GM
Clinical RA Shank Handle	16	IPD/MC-00-16
Laboratory RA Shank Handle	70	IPD/ML-00-70
RA Shank Ratchet	90	IPD/DI-00-90
Ratchet adapter	-	IPD/DI-KA-90
PSD and insert extractor	-	IPD/LL-PS-01

Please see page 210 for more information.



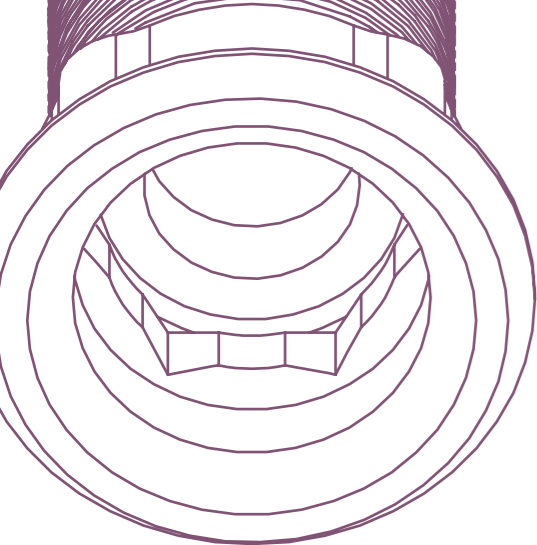

NEODENT®

RC GM ABUTMENT

Prosthetic platform [RP ø4.8]

SCAN BODY

Indication	Height (mm)	RP ø4.8
Scan Body	10	IPD/RC-SR-00

Captive screw included. 1.20 Hex Screwdriver.



Ti-BASE Custom Ti-Base System®

Indication	Post Height (mm)	Gingival Height (mm)	RP ø4.8
Heart icon	8.0	0.5	IPD/RC-IR-00/3D
	Cutting guide KIT		IPD/KT-IR-00

Please see page 204 for the IPD Custom Interface System accessories.



SCREWS

For straight channels			Torque value	RP ø4.8
IPD and OEM compatible			10 Ncm	
Screwdriver	Coating	Seat		
Neo GM	-	Conical		IPD/RC-TR-00
Neo GM	TiN	Conical		IPD/RC-TR-00/TIN
Neo GM	BLC	Conical		IPD/RC-TR-00/BLC
For ASC options			Torque value	RP ø4.8
			10 Ncm	
Screwdriver	Coating	Seat		
TPA	TiN	Conical		IPD/RC-TR-50



ANALOGS

Type	RP ø4.8						
Standard	IPD/RC-AR-00						
	Full set						
	IPD/RC-AR-90/3D						
Digital	<table border="1"> <tr> <td>Analogue</td> <td></td> </tr> <tr> <td>Bottom Screw</td> <td></td> </tr> <tr> <td>Side Screw</td> <td></td> </tr> </table>	Analogue		Bottom Screw		Side Screw	
Analogue							
Bottom Screw							
Side Screw							



[RETURN TO INDEX](#)

Co-Cr BASE ABUTMENT

Cr-Co Base for analogic workflow		RP ø4.8
Indication	Angulation	
Heart icon	0°	IPD/RC-BR-00
	15°	IPD/RC-BR-10
	25°	IPD/RC-BR-20
Cr-Co Base for digital workflow		RP ø4.8
Indication	Angulation	
Heart icon	Straight/ASC	IPD/RC-BR-00/3D
	Scan Body	IPD/SC-AN-B1

All ASC CoCr analogic workflow abutments include the relevant TPA screw.



TEMPORARY ABUTMENT / OPEN TRAY COPING

Indication	Gingival Height (mm)	RP ø4.8
Heart icon	0.2	IPD/RC-PR-06
	Long coping screw	IPD/RC-TR-00/C

The same abutment can be used as a temporary abutment with the occlusal screw or as an impression coping using the coping screw.



HEALING ABUTMENT

Gingival Height (mm)	Head Diameter (mm)	RP ø4.8
	ø4.05	
4.75		IPD/RC-DR-03
	Screw	IPD/RC-TR-00

Screw not included



SCREWDRIVERS

Type	Length (mm)	RP ø4.8
Implant system Screwdriver		
Neo GM	18	IPD/PU-01-18
	25	IPD/PU-01-25
	32	IPD/PU-01-32
IPD Scan Body and extra Screwdrivers		
1.20 Hex	18	IPD/PH-20-18
	25	IPD/PH-20-25
	32	IPD/PH-20-32
ASC Screwdriver		
TPA	18	IPD/KA-CT-18
	25	IPD/KA-CT-25
	32	IPD/KA-CT-32



ACCESSORIES

Indication	Length (mm)	RP ø4.8
Clinical RA Shank Handle	16	IPD/MC-00-16
Laboratory RA Shank Handle	70	IPD/ML-00-70
RA Shank Ratchet	90	IPD/DI-00-90
Ratchet adapter	-	IPD/DI-KA-90

Please see page 210 for more information.



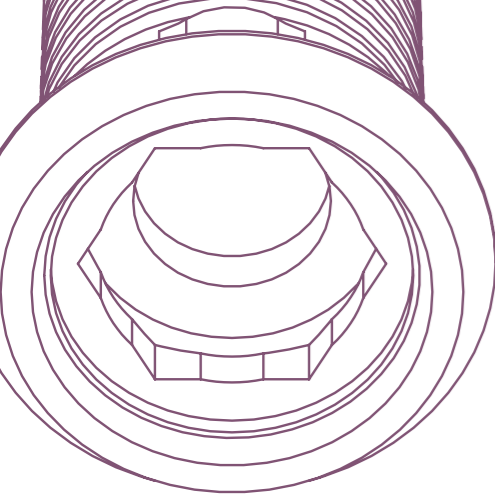

NEODENT®

RD GM MICRO ABUTMENT

Prosthetic platform [Ø3.5]

SCAN BODY / SCAN DATA MARKER

	Indication	Height (mm)	Ø3.5
Scan Body		10	IPD/RD-SN-00
		10	IPD/RD-SN-01
One Shot iQ		6	IPD/RD-SN-03
Reverse iQ			IPD/RD-SN-00/RS

Captive screw included except on Reverse Marker IQ. H1.20 Screwdriver

Ti-BASE Custom Ti-Base System®

Indication	Post Height (mm)	Gingival Height (mm)	RP Ø4.8
	4.0	0.5	IPD/RD-IN-00/3D
			Cutting guide KIT
	6.5	0.3	IPD/RD-IN-01/3D
			Cutting guide KIT
			IPD/KT-IN-01

Please see page 204 for the IPD Custom Interface System accessories.

SCREWS

			Ø3.5
IPD and OEM compatible	For straight channels	Torque value	10 Ncm
Screwdriver	Coating	Seat	
Neo GM	-	Flat	IPD/RD-TN-00
Neo GM	TiN	Flat	IPD/RD-TN-00/TiN
Neo GM	BLC	Flat	IPD/RD-TN-00/BLC
			10 Ncm
Screwdriver	Coating	Seat	
TPA	TiN	Flat	IPD/RD-TN-50

ANALOGS

Type			Ø3.5
Standard			IPD/RD-AN-00
	Full set		IPD/RD-AN-90/3D
Digital		Analog	
		Bottom Screw	
		Side Screw	



[RETURN TO INDEX](#)

Co-Cr BASE ABUTMENT

		Ø3.5
Co-Cr Base for analogic workflow		
Indication	Angulation	
	0°	IPD/RD-BN-00
	15°	IPD/RD-BN-10
	25°	IPD/RD-BN-20
	0°	IPD/RD-BN-01
	15°	IPD/RD-BN-11
	25°	IPD/RD-BN-21
Co-Cr Base for digital workflow		
Indication	Angulation	
	Straight/ASC	IPD/RD-BN-00/3D
	Straight/ASC	IPD/RD-BN-01/3D
	Scan Body	IPD/SC-AN-B1

All ASC CoCr analogic workflow abutments include the relevant TPA screw.

TEMPORARY ABUTMENT / OPEN TRAY COPING

Indication	Gingival Height (mm)	Ø3.5
	1.5	IPD/RD-PN-06
	1.5	IPD/RD-PN-07
	Long coping screw	IPD/RD-TN-00/C

The same abutment can be used as a temporary abutment with the occlusal screw or as an impression coping using the coping screw.

HEALING ABUTMENT

Gingival Height (mm)	Head Diameter (mm)	Ø3.5
3.25		IPD/RD-DN-03
	Screw	IPD/RD-TN-00

Screw not included.

SCREWDRIVERS

Type	Length (mm)	Ø3.5
Implant system Screwdriver		
Neo GM	18	IPD/PU-01-18
	25	IPD/PU-01-25
	32	IPD/PU-01-32
IPD Scan Body and extra Screwdrivers		
1.20 Hex	18	IPD/PH-20-18
	25	IPD/PH-20-25
	32	IPD/PH-20-32
ASC Screwdriver		
TPA	18	IPD/KA-CT-18
	25	IPD/KA-CT-25
	32	IPD/KA-CT-32

ACCESSORIES

Indication	Length (mm)	Ø3.5
Clinical RA Shank Handle	16	IPD/MC-00-16
Laboratory RA Shank Handle	70	IPD/ML-00-70
RA Shank Ratchet	90	IPD/DI-00-90
Ratchet adapter		IPD/DI-KA-90

Please see page 210 for more information.



BEGO® SEMADOS®

SB SC/RS

Prosthetic platform [ø3.25-ø3.75 / ø4.1 / ø4.5 / ø5.5]

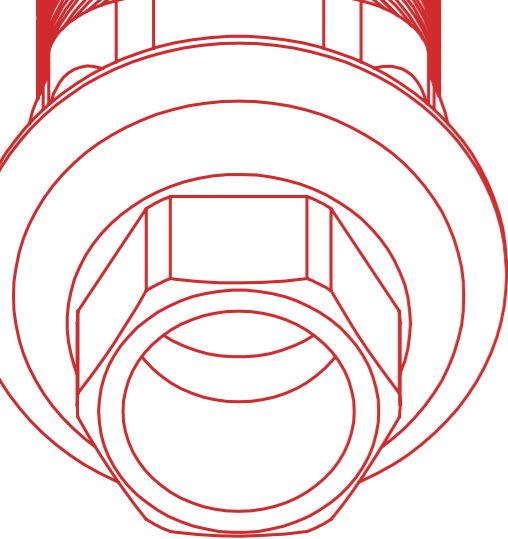

SCAN BODY*

*Check availability

Indication	Height (mm)	ø3.25-ø3.75	ø4.1	ø4.5	ø5.5
Scan Body	10	IPD/SB-SN-00	IPD/SB-SR-00	IPD/SB-SW-00	IPD/SB-SX-00
	15	IPD/SB-SN-02	IPD/SB-SR-02	IPD/SB-SW-02	-
	10	IPD/SB-SN-01	IPD/SB-SR-01	IPD/SB-SW-01	-

Captive screw included. 1.20 Hex Screwdriver.

Ti-BASE IPD Custom Ti-Base System®

Indication	Gingival Height (mm)	ø3.25-ø3.75	ø4.1	ø4.5	ø5.5
Scan Body	0.5	IPD/SB-IN-00/3D	IPD/SB-IR-00/3D	IPD/SB-IW-00/3D	-
	1.5	IPD/SB-IN-02/3D	IPD/SB-IR-02/3D	IPD/SB-IW-02/3D	-
	2.5	IPD/SB-IN-04/3D	IPD/SB-IR-04/3D	IPD/SB-IW-04/3D	-
	Cutting guide KIT		IPD/KT-IN-00	IPD/KT-IR-00	IPD/KT-IW-00
Scan Body	0.5	IPD/SB-IN-01/3D	IPD/SB-IR-01/3D	IPD/SB-IW-01/3D	-
	1.5	IPD/SB-IN-03/3D	IPD/SB-IR-03/3D	IPD/SB-IW-03/3D	-
	2.5	IPD/SB-IN-05/3D	IPD/SB-IR-05/3D	IPD/SB-IW-05/3D	-
	Cutting guide KIT		IPD/KT-IN-01	IPD/KT-IR-01	IPD/KT-IW-01

Please see page 204 for the IPD Custom Ti-Base System accessories.

IPDMILLED SYSTEM* NEW

*Check availability

Indication	Material	Diameter (mm)	ø3.25-ø3.75	ø4.1	ø4.5	ø5.5
IPD Blank System (Compatible with NT/IPD Holders)						
	Ti	12	IPD/SB-XN-00	IPD/SB-XR-00	IPD/SB-XW-00	IPD/SB-XX-00
Mill Analog			IPD/SB-AN-00/X	IPD/SB-AR-00/X	IPD/SB-AW-00/X	IPD/SB-AX-00/X
TYPE A System (Compatible with DESS® Holders)						
	Ti	15	PR/SB-XN-15/A	-	-	-

All premilled abutments include 2 titanium screws.

SCREWS

IPD and OEM compatible	Torque value	ø3.25-ø3.75	ø4.1	ø4.5	ø5.5
For straight channels	30 Ncm				
Screwdriver	Coating	Seat			
1.25 Hex	-	Conical	IPD/SB-TR-00	IPD/SB-TR-00	IPD/SB-TR-00
1.25 Hex	TiN	Conical	IPD/SB-TR-00/TiN	IPD/SB-TR-00/TiN	IPD/SB-TR-00/TiN
1.25 Hex	BLC	Conical	IPD/SB-TR-00/BLC	IPD/SB-TR-00/BLC	IPD/SB-TR-00/BLC
For ASC options		Torque value	25 Ncm	25 Ncm	25 Ncm
Screwdriver	Coating	Seat			
TPA	TiN	Conical	IPD/SB-TR-50	IPD/SB-TR-50	IPD/SB-TR-50



RETURN TO INDEX

MULTI-UNIT ABUTMENT

Angulation	Indication	Gingival Height (mm)	ø3.25-ø3.75	ø4.1	ø4.5	ø5.5
0°		1.5	IPD/SB-MN-01	IPD/SB-MR-01	IPD/SB-MW-01	-
		2.5	IPD/SB-MN-02	IPD/SB-MR-02	IPD/SB-MW-02	-
		3.5	IPD/SB-MN-03	IPD/SB-MR-03	-	-
		4.5	IPD/SB-MN-04	IPD/SB-MR-04	-	-
		5.5	IPD/SB-MN-05	-	-	-
17°		2.5	IPD/SB-MN-12	IPD/SB-MR-12	IPD/SB-MW-12	-
		3.5	IPD/SB-MN-13	-	-	-
30°		3.5	IPD/SB-MN-33	IPD/SB-MR-33	IPD/SB-MW-33	-
		4.5	IPD/SB-MN-34	-	-	-
Replacement Screw for Angled MUA			IPD/KA-MT-10	IPD/KA-MT-10	IPD/KA-MT-10	-

Straight Multi-unit abutments can be used for single and multiple restorations. Please see page 206 for the Multi-unit system accessories.



ANALOGS

Type	ø3.25-ø3.75	ø4.1	ø4.5	ø5.5
Standard	IPD/SB-AN-00	IPD/SB-AR-00	IPD/SB-AW-00	-
	Full set	IPD/SB-AN-90/3D	IPD/SB-AR-90/3D	IPD/SB-AW-90/3D
Digital	Analog			
	Bottom Screw			
	Side Screw			



Co-Cr BASE ABUTMENT

Indication	Angulation	ø3.25-ø3.75	ø4.1	ø4.5	ø5.5
Co-Cr Base for analogic workflow					
Scan Body	0°	IPD/SB-BN-00	IPD/SB-BR-00	IPD/SB-BW-00	-
	15°	IPD/SB-BN-10	IPD/SB-BR-10	IPD/SB-BW-10	-
	25°	IPD/SB-BN-20	IPD/SB-BR-20	IPD/SB-BW-20	-
Scan Body	0°	IPD/SB-BN-01	IPD/SB-BR-01	IPD/SB-BW-01	-
	15°	IPD/SB-BN-11	IPD/SB-BR-11	IPD/SB-BW-11	-
	25°	IPD/SB-BN-21	IPD/SB-BR-21	IPD/SB-BW-21	-
Co-Cr Base for digital workflow					
Scan Body	Straight/ASC	IPD/SB-BN-00/3D	IPD/SB-BR-00/3D	IPD/SB-BW-00/3D	-
	Straight/ASC	IPD/SB-BN-01/3D	IPD/SB-BR-01/3D	IPD/SB-BW-01/3D	-
Scan Body		IPD/SC-AN-B1	IPD/SC-AN-B1	IPD/SC-AN-B1	-

All ASC CoCr analogic workflow abutments include the relevant TPA screw.



PSD OVERDENTURE ABUTMENT

Indication	Gingival Height (mm)	ø3.25-ø3.75	ø4.1	ø4.5	ø5.5
	1.0	IPD/SB-LN-01	IPD/SB-LR-01	IPD/SB-LW-01	-
	2.0	IPD/SB-LN-02	IPD/SB-LR-02	IPD/SB-LW-02	-
	3.0	IPD/SB-LN-03	IPD/SB-LR-03	IPD/SB-LW-03	-
	4.0	IPD/SB-LN-04	IPD/SB-LR-04	IPD/SB-LW-04	-
	5.0	IPD/SB-LN-05	IPD/SB-LR-05	IPD/SB-LW-05	-

Please see page 205 for the PSD system accessories.



TEMPORARY ABUTMENT / OPEN TRAY COPING

Indication	Gingival Height (mm)	ø3.25-ø3.75	ø4.1	ø4.5	ø5.5
	1.5	IPD/SB-PN-06	IPD/SB-PR-06	IPD/SB-PW-06	-
	1.5	IPD/SB-PN-07	IPD/SB-PR-07	IPD/SB-PW-07	-
Long coping screw		IPD/SB-TN-00/C	IPD/SB-TR-00/C	IPD/SB-TR-00/C	-

The same abutment can be used as a temporary abutment with the occlusal screw or as an impression coping using the coping screw.

HEALING ABUTMENT

Gingival Height (mm)	Head Diameter (mm)				
	ø3.25-ø3.75	ø4.1	ø4.5	ø5.5	
3.0	IPD/SB-DN-03	IPD/SB-DR-03	IPD/SB-DW-03	-	
5.0	IPD/SB-DN-05	IPD/SB-DR-05	IPD/SB-DW-05	-	
7.0	IPD/SB-DN-07	IPD/SB-DR-07	IPD/SB-DW-07	-	

SCREWDRIVERS

Type	Length (mm)	ø3.25-ø3.75	ø4.1	ø4.5	ø5.5
Implant system Screwdriver					
1.25 Hex	18	IPD/PH-25-18	IPD/PH-25-18	IPD/PH-25-18	IPD/PH-25-18
	25	IPD/PH-25-25	IPD/PH-25-25	IPD/PH-25-25	IPD/PH-25-25
	32	IPD/PH-25-32	IPD/PH-25-32	IPD/PH-25-32	IPD/PH-25-32
IPD Scan Body and extra Screwdrivers					
1.20 Hex	18	IPD/PH-20-18	IPD/PH-20-18	IPD/PH-20-18	IPD/PH-20-18
	25	IPD/PH-20-25	IPD/PH-20-25	IPD/PH-20-25	IPD/PH-20-25
	32	IPD/PH-20-32	IPD/PH-20-32	IPD/PH-20-32	IPD/PH-20-32
ASC Screwdriver					
TPA	18	IPD/KA-CT-18	IPD/KA-CT-18	IPD/KA-CT-18	IPD/KA-CT-18
	25	IPD/KA-CT-25	IPD/KA-CT-25	IPD/KA-CT-25	IPD/KA-CT-25
	32	IPD/KA-CT-32	IPD/KA-CT-32	IPD/KA-CT-32	IPD/KA-CT-32
PSD Screwdriver					
PSD	25	IPD/LL-PS-00	IPD/LL-PS-00	IPD/LL-PS-00	-

ACCESSORIES

Indication	Length (mm)	ø3.25-ø3.75	ø4.1	ø4.5	ø5.5
Clinical RA Shank Handle	16	IPD/MC-00-16	IPD/MC-00-16	IPD/MC-00-16	IPD/MC-00-16
Laboratory RA Shank Handle	70	IPD/ML-00-70	IPD/ML-00-70	IPD/ML-00-70	IPD/ML-00-70
RA Shank Ratchet	90	IPD/DI-00-90	IPD/DI-00-90	IPD/DI-00-90	IPD/DI-00-90
Ratchet adapter		IPD/DI-KA-90	IPD/DI-KA-90	IPD/DI-KA-90	IPD/DI-KA-90
PSD and insert extractor tool		IPD/LL-PS-01	IPD/LL-PS-01	IPD/LL-PS-01	-

Please see page 210 for more information.



MIS®

TA SEVEN®

Prosthetic platform [Narrow NP ø3.3 / Standard SP / Wide WP]

SCAN BODY

	Indication	Height (mm)	Narrow NP ø3.3	Standard SP	Wide WP
Scan Body		10	IPD/TA-ST-00	IPD/FA-SN-00	IPD/FA-SR-00
		15	IPD/TA-ST-02	IPD/FA-SN-02	IPD/FA-SR-02
		10	IPD/TA-ST-01	IPD/FA-SN-01	IPD/FA-SR-01

Captive screw included. 1.20 Hex Screwdriver.



Ti-BASE Custom Ti-Base System®

Indication	Gingival Height (mm)	Narrow NP ø3.3	Standard SP	Wide WP
	0.5	IPD/TA-IT-00/3D	IPD/FA-IN-00/3D	IPD/FA-IR-00/3D
	1.5	IPD/TA-IT-02/3D	IPD/FA-IN-02/3D	IPD/FA-IR-02/3D
	2.5	IPD/TA-IT-04/3D	IPD/FA-IN-04/3D	IPD/FA-IR-04/3D
Cutting guide KIT		IPD/KT-IN-00	IPD/KT-IN-00	IPD/KT-IR-00
	0.5	IPD/TA-IT-01/3D	IPD/FA-IN-01/3D	IPD/FA-IR-01/3D
	1.5	IPD/TA-IT-03/3D	IPD/FA-IN-03/3D	IPD/FA-IR-03/3D
	2.5	IPD/TA-IT-05/3D	IPD/FA-IN-05/3D	IPD/FA-IR-05/3D
Cutting guide KIT		IPD/KT-IN-01	IPD/KT-IN-01	IPD/KT-IR-01

Please see page 204 for the IPD Custom Interface System accessories.



CEREC® TI-BASE SYSTEM

Indication	Gingival Height (mm)	Narrow NP ø3.3	Standard SP	Wide WP
	0.5	-	IPD/FA-IN-00/SI	IPD/FA-IR-00/SI
	1.5	-	IPD/FA-IN-02/SI	IPD/FA-IR-02/SI
	2.5	-	IPD/FA-IN-04/SI	IPD/FA-IR-04/SI
Cerec Block (S/L)		-	S	L
Cerec Library Code		-	B C 3.4	NB B 4.1

TiN screw included.



IPDMILLED SYSTEM*

*Check availability

Indication	Material	Diameter (mm)	Narrow NP ø3.3	Standard SP	Wide WP
IPD Blank System (Compatible with NT/IPD Holders)					
	Ti	12	IPD/TA-XN-00	IPD/TA-XR-00	IPD/TA-XW-00
Mill Analog					
			IPD/TA-AN-00/X	IPD/TA-AR-00/X	IPD/TA-AW-00/X
TYPE A System (Compatible with DESS® Holders)					
	Ti	15	-	PR/TA-XR-15/A	-

All premilled abutments include 2 titanium screws.



RETURN TO INDEX

SCREWS

		Narrow NP ø3.3 ●			Standard SP ●			Wide WP ●			
IPD and OEM compatible		For straight channels	Torque value			30 Ncm			30 Ncm		
Screwdriver	Coating	Seat	IPD/TA-TT-00			IPD/FA-TR-00			IPD/FA-TR-00		
1.25 Hex	-	Conical	IPD/TA-TT-00			IPD/FA-TR-00			IPD/FA-TR-00		
1.25 Hex	TiN	Conical	IPD/TA-TT-00/TiN			IPD/FA-TR-00/TiN			IPD/FA-TR-00/TiN		
1.25 Hex	BLC	Conical	IPD/TA-TT-00/BLC			IPD/FA-TR-00/BLC			IPD/FA-TR-00/BLC		
		For ASC options			Torque value			25 Ncm			
Screwdriver	Coating	Seat	IPD/TA-TT-50			IPD/FA-TR-50			IPD/FA-TR-50		
TPA	TiN	Conical	IPD/TA-TT-50			IPD/FA-TR-50			IPD/FA-TR-50		
		IPDmilled compatible			Torque value			30 Ncm			
Screwdriver	Coating	Seat	IPD/TA-TT-00			IPD/TA-TR-00/X			IPD/TA-TR-00/X		
1.25 Hex	-	Conical	IPD/TA-TT-00			IPD/TA-TR-00/X			IPD/TA-TR-00/X		



MULTI-UNIT ABUTMENT

Angulation	Indication	Gingival Height (mm)	Narrow NP ø3.3 ●	Standard SP ●	Wide WP ●
0°		0.9	-	IPD/FA-MN-00	-
		1.0	IPD/TA-MT-01	-	-
		1.5	-	IPD/FA-MN-01	IPD/FA-MR-01
		2.0	IPD/TA-MT-02	-	-
		2.5	-	IPD/FA-MN-02	IPD/FA-MR-02
		3.0	IPD/TA-MT-03	-	-
17°		2.5	-	IPD/FA-MN-03	IPD/FA-MR-03
		3.0	-	IPD/FA-MN-04	IPD/FA-MR-04
		3.5	-	IPD/FA-MN-12	-
		4.0	-	IPD/FA-MN-13	-
30°		3.5	-	IPD/FA-MN-33	IPD/FA-MR-33
		4.5	-	IPD/FA-MN-34	IPD/FA-MR-34
		Replacement Screw for Angled MUA		-	IPD/KA-MT-08

Straight Multi-unit abutments can be used for single and multiple restorations. Please see page 206 for the Multi-unit system accessories.



MULTI-UNIT AP ABUTMENT* NEW

*Check availability

Angulation	Indication	Gingival Height (mm)	Narrow NP ø3.3 ●	Standard SP ●	Wide WP ●
17°		2.5	-	IPD/FA-MN-12/AP	IPD/FA-MR-12/AP
		3.5	-	IPD/FA-MN-13/AP	IPD/FA-MR-13/AP
30°		3.5	-	IPD/FA-MN-33/AP	IPD/FA-MR-33/AP
		4.5	-	IPD/FA-MN-34/AP	IPD/FA-MR-34/AP
Replacement Screw for Angled MUA AP		-	-	IPD/KA-MT-08/BLC	IPD/KA-MT-08/BLC

Please see page 206 for the Multi-unit system accessories.



ANALOGS

Type	Narrow NP ø3.3 ●			Standard SP ●			Wide WP ●		
Standard	IPD/TA-AT-00			IPD/FA-AN-00			IPD/FA-AR-00		
	Full set			IPD/TA-AT-90/3D			IPD/FA-AN-90/3D		
Digital	Analog			IPD/TA-AT-90/3D			IPD/FA-AR-90/3D		
	Bottom Screw			IPD/TA-AT-90/3D			IPD/FA-AR-90/3D		
	Side Screw			IPD/TA-AT-90/3D			IPD/FA-AR-90/3D		



Co-Cr BASE ABUTMENT

		Narrow NP ø3.3 ●			Standard SP ●			Wide WP ●		
Co-Cr Base for analogic workflow		Torque value			30 Ncm			30 Ncm		
Indication	Angulation	IPD/TA-BT-00			IPD/FA-BN-00			IPD/FA-BR-00		
	0°	IPD/TA-BT-00			IPD/FA-BN-00			IPD/FA-BR-00		
	15°	IPD/TA-BT-10			IPD/FA-BN-10			IPD/FA-BR-10		
	25°	IPD/TA-BT-20			IPD/FA-BN-20			IPD/FA-BR-20		
	0°	IPD/TA-BT-01			IPD/FA-BN-01			IPD/FA-BR-01		
	15°	IPD/TA-BT-11			IPD/FA-BN-11			IPD/FA-BR-11		
	25°	IPD/TA-BT-21			IPD/FA-BN-21			IPD/FA-BR-21		
Co-Cr Base for digital workflow		Torque value			25 Ncm			25 Ncm		
Indication	Angulation	IPD/TA-BT-00/3D			IPD/FA-BN-00/3D			-		
	Straight / ASC	IPD/TA-BT-00/3D			IPD/FA-BN-00/3D			-		
	Straight	-			-			IPD/FA-BR-00/3D		
	ASC	-			-			IPD/FA-BR-A0/3D		
	Straight / ASC	IPD/TA-BT-01/3D			IPD/FA-BN-01/3D			-		
	Straight	-			-			IPD/FA-BR-01/3D		
	ASC	-			-			IPD/FA-BR-A1/3D		
Scan Body		IPD/SC-AN-B1			IPD/SC-AN-B1			IPD/SC-AN-B1		

All ASC CoCr analogic workflow abutments include the relevant TPA screw.



CASTABLE ABUTMENT

Indication	Narrow NP ø3.3 ●			Standard SP ●			Wide WP ●		
	-			IPD/FA-HN-00			IPD/FA-HR-00		
	-			IPD/FA-RN-00			IPD/FA-RR-00		



PSD OVERDENTURE ABUTMENT

Indication	Gingival Height (mm)	Narrow NP ø3.3 ●	Standard SP ●	Wide WP ●
	1.0	IPD/TA-LT-01	IPD/FA-LN-01	IPD/FA-LR-01
	2.0	IPD/TA-LT-02	IPD/FA-LN-02	IPD/FA-LR-02
	3.0	IPD/TA-LT-03	IPD/FA-LN-03	IPD/FA-LR-03
	4.0	IPD/TA-LT-04	IPD/FA-LN-04	IPD/FA-LR-04
	5.0	IPD/TA-LT-05	IPD/FA-LN-05	IPD/FA-LR-05

Please see page 205 for the PSD system accessories.



COPING ABUTMENT

Type	Narrow NP ø3.3 ●			Standard SP ●			Wide WP ●		
Open tray	-			IPD/FA-CN-00			-		
Classic Design	-			-			-		



TEMPORARY ABUTMENT / OPEN TRAY COPING

Indication	Gingival Height (mm)	Narrow NP ø3.3 ●	Standard SP ●	Wide WP ●
	1.5	IPD/TA-PT-06	IPD/FA-PN-06	IPD/FA-PR-06
	1.5	IPD/TA-PT-07	IPD/FA-PN-07	IPD/FA-PR-07
Long coping screw		IPD/TA-TT-00/C	IPD/FA-TR-00/C	IPD/FA-TR-00/C

The same abutment can be used as a temporary abutment with the occlusal screw or as an impression coping using the coping screw.



HEALING ABUTMENT

Gingival Height (mm)	Head Diameter (mm)	Narrow NP ø3.3	Standard SP	Wide WP
1.5		-	IPD/FA-DN-01	IPD/FA-DR-01
2.0		IPD/TA-DT-02	-	-
3.0		IPD/TA-DT-03	IPD/FA-DN-03	IPD/FA-DR-03
4.0		IPD/TA-DT-04	-	-
5.0		IPD/TA-DT-05	IPD/FA-DN-05	IPD/FA-DR-05



TI CEMENT-RETAINED ABUTMENT

Indication	Angulation	Gingival Height	Narrow NP ø3.3	Standard SP	Wide WP
	0°	1.0	-	IPD/FA-PN-00	-
		2.0	-	IPD/FA-PN-01	-
	15°	1.0	-	IPD/FA-PN-02	-
		2.0	-	IPD/FA-PN-04	-
	25°	1.0	-	IPD/FA-PN-03	-
		2.0	-	IPD/FA-PN-05	-



SCREWDRIVERS

Type	Length (mm)	Narrow NP ø3.3	Standard SP	Wide WP
Implant system Screwdriver				
1.25 Hex	18	IPD/PH-25-18	IPD/PH-25-18	IPD/PH-25-18
	25	IPD/PH-25-25	IPD/PH-25-25	IPD/PH-25-25
	32	IPD/PH-25-32	IPD/PH-25-32	IPD/PH-25-32
IPD Scan Body and extra Screwdrivers				
1.20 Hex	18	IPD/PH-20-18	IPD/PH-20-18	IPD/PH-20-18
	25	IPD/PH-20-25	IPD/PH-20-25	IPD/PH-20-25
	32	IPD/PH-20-32	IPD/PH-20-32	IPD/PH-20-32
ASC Screwdriver				
TPA	18	IPD/KA-CT-18	IPD/KA-CT-18	IPD/KA-CT-18
	25	IPD/KA-CT-25	IPD/KA-CT-25	IPD/KA-CT-25
	32	IPD/KA-CT-32	IPD/KA-CT-32	IPD/KA-CT-32
PSD Screwdriver				
PSD	25	IPD/LL-PS-00	IPD/LL-PS-00	IPD/LL-PS-00



ACCESSORIES

Indication	Length (mm)	Narrow NP ø3.3	Standard SP	Wide WP
Clinical RA Shank Handle	16	IPD/MC-00-16	IPD/MC-00-16	IPD/MC-00-16
Laboratory RA Shank Handle	70	IPD/ML-00-70	IPD/ML-00-70	IPD/ML-00-70
RA Shank Ratchet	90	IPD/DI-00-90	IPD/DI-00-90	IPD/DI-00-90
Ratchet adapter		IPD/DI-KA-90	IPD/DI-KA-90	IPD/DI-KA-90
PSD and insert extractor tool		IPD/LL-PS-01	IPD/LL-PS-01	IPD/LL-PS-01

Please see page 210 for more information.



MIS®

TB C1®

Prosthetic platform [Narrow NP / Standard SP / Wide WP]

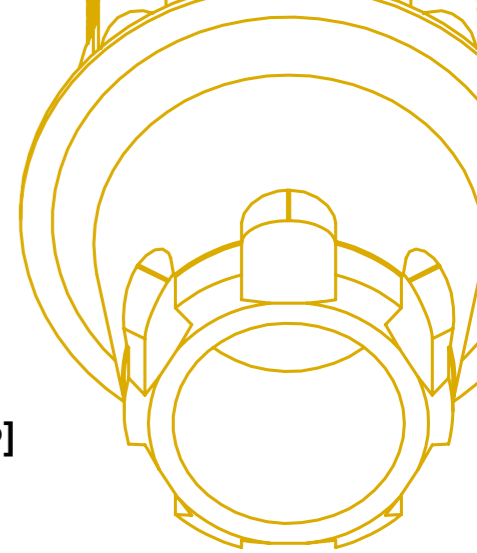

SCAN BODY

Indication	Height (mm)	Narrow NP	Standard SP	Wide WP
	10	IPD/TB-SN-00	IPD/TB-SR-00	IPD/TB-SW-00
	15	IPD/TB-SN-02	IPD/TB-SR-02	IPD/TB-SW-02
	10	IPD/TB-SN-01	IPD/TB-SR-01	IPD/TB-SW-01

Captive screw included. 1.20 Hex Screwdriver.



Ti-BASE *ipd* Custom Ti-Base System®

Indication	Gingival Height (mm)	Narrow NP	Standard SP	Wide WP
	0.5	IPD/TB-IN-00/3D	-	IPD/TB-IW-00/3D
	0.7	-	IPD/TB-IR-00/3D	-
	1.5	IPD/TB-IN-02/3D	IPD/TB-IR-02/3D	IPD/TB-IW-02/3D
	2.5	IPD/TB-IN-04/3D	IPD/TB-IR-04/3D	IPD/TB-IW-04/3D
	3.5	IPD/TB-IN-06/3D	IPD/TB-IR-06/3D	-
	Cutting guide KIT		IPD/KT-IN-00	IPD/KT-IR-00
	0.5	IPD/TB-IN-01/3D	-	IPD/TB-IW-01/3D
	0.7	-	IPD/TB-IR-01/3D	-
	1.5	IPD/TB-IN-03/3D	IPD/TB-IR-03/3D	IPD/TB-IW-03/3D
	2.5	IPD/TB-IN-05/3D	IPD/TB-IR-05/3D	IPD/TB-IW-05/3D
	3.5	IPD/TB-IN-07/3D	IPD/TB-IR-07/3D	-
	Cutting guide KIT		IPD/KT-IN-01	IPD/KT-IR-01

Please see page 204 for the IPD Custom Interface System accessories.



CEREC® TI-BASE SYSTEM

Indication	Gingival Height (mm)	Narrow NP	Standard SP	Wide WP
	0.5	-	IPD/TB-IR-00/SI	-
	1.5	-	IPD/TB-IR-02/SI	-
	2.5	-	IPD/TB-IR-04/SI	-
Cerec Block (S/L)		-	L	-
Cerec Library Code		-	NB B 4.1	-

TiN screw included.



[RETURN TO INDEX](#)

SCREWDRIVERS

Type	Length (mm)	Narrow NP ●	Standard SP ●	Wide WP ●
Implant system Screwdriver				
1.25 Hex	18	IPD/PH-25-18	IPD/PH-25-18	IPD/PH-25-18
	25	IPD/PH-25-25	IPD/PH-25-25	IPD/PH-25-25
	32	IPD/PH-25-32	IPD/PH-25-32	IPD/PH-25-32
IPD Scan Body and extra Screwdrivers				
1.20 Hex	18	IPD/PH-20-18	IPD/PH-20-18	IPD/PH-20-18
	25	IPD/PH-20-25	IPD/PH-20-25	IPD/PH-20-25
	32	IPD/PH-20-32	IPD/PH-20-32	IPD/PH-20-32
ASC Screwdriver				
TPA	18	IPD/KA-CT-18	IPD/KA-CT-18	IPD/KA-CT-18
	25	IPD/KA-CT-25	IPD/KA-CT-25	IPD/KA-CT-25
	32	IPD/KA-CT-32	IPD/KA-CT-32	IPD/KA-CT-32
PSD Screwdriver				
PSD	25	IPD/LL-PS-00	IPD/LL-PS-00	IPD/LL-PS-00



ACCESSORIES

Indication	Length (mm)	Narrow NP ●	Standard SP ●	Wide WP ●
Clinical RA Shank Handle	16	IPD/MC-00-16	IPD/MC-00-16	IPD/MC-00-16
Laboratory RA Shank Handle	70	IPD/ML-00-70	IPD/ML-00-70	IPD/ML-00-70
RA Shank Ratchet	90	IPD/DI-00-90	IPD/DI-00-90	IPD/DI-00-90
Ratchet adapter		IPD/DI-KA-90	IPD/DI-KA-90	IPD/DI-KA-90
PSD and insert extractor tool		IPD/LL-PS-01	IPD/LL-PS-01	IPD/LL-PS-01



Please see page 210 for more information.

NEW
IN CATALOGUE

MIS®

TC V3®

Prosthetic platform [Narrow NP / Standard SP]

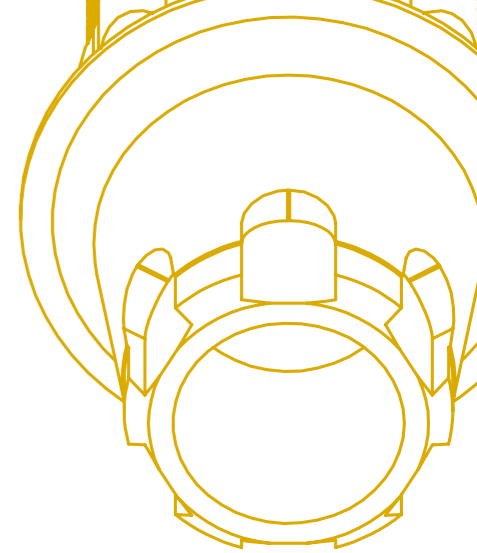

SCAN BODY

	Indication	Height (mm)	Narrow NP ●	Standard SP ●
Scan Body		10	IPD/TC-SN-00	IPD/TB-SR-00
		15	IPD/TC-SN-02	IPD/TB-SR-02
		10	IPD/TC-SN-01	IPD/TB-SR-01



Captive screw included. 1.20 Hex Screwdriver.

Ti-BASE Custom Ti-Base System®

Indication	Gingival Height (mm)	Narrow NP ●	Standard SP ●
	0.5	IPD/TC-IN-00/3D	-
	0.7	-	IPD/TB-IR-00/3D
	1.5	IPD/TC-IN-02/3D	IPD/TB-IR-02/3D
	2.5	IPD/TC-IN-04/3D	IPD/TB-IR-04/3D
	3.5	-	IPD/TB-IR-06/3D
	Cutting guide KIT		IPD/KT-IN-00
	0.5	IPD/TC-IN-01/3D	-
	0.7	-	IPD/TB-IR-01/3D
	1.5	IPD/TC-IN-03/3D	IPD/TB-IR-03/3D
	2.5	IPD/TC-IN-05/3D	IPD/TB-IR-05/3D
	3.5	-	IPD/TB-IR-07/3D
	Cutting guide KIT		IPD/KT-IN-01



Please see page 204 for the IPD Custom Interface System accessories.

CEREC® TI-BASE SYSTEM

Indication	Gingival Height (mm)	Narrow NP ●	Standard SP ●
	0.5	-	IPD/TB-IR-00/SI
	1.5	-	IPD/TB-IR-02/SI
	2.5	-	IPD/TB-IR-04/SI
		Cerec Block (S/L)	L
		Cerec Library Code	NB B 4.1

TiN screw included.



RETURN TO INDEX

IPDMILLED SYSTEM* **NEW**

*Check availability

Indication	Material	Diameter (mm)	Narrow NP	Standard SP
TYPE IPD System (Compatible with NT/IPD Holders)				
	Ti	12	-	IPD/TB-XR-00
Mill Analog			-	IPD/TB-AR-00/X
TYPE A System (Compatible with DESS [®] Holders)				
	Ti	15	-	PR/TB-XR-15/A

All premilled abutments include 2 titanium screws.

SCREWS

IPD and OEM compatible	For straight channels	Torque value	Narrow NP	Standard SP
Screwdriver	Coating	Seat		
1.25 Hex	-	Conical	IPD/TB-TN-00	IPD/TB-TR-00
1.25 Hex	TiN	Conical	IPD/TB-TN-00/TiN	IPD/TB-TR-00/TiN
1.25 Hex	BLC	Conical	IPD/TB-TN-00/BLC	IPD/TB-TR-00/BLC
	For ASC options	Torque value	20 Ncm	25 Ncm
Screwdriver	Coating	Seat		
TPA	TiN	Conical	IPD/TB-TN-50	IPD/TB-TR-50



MULTI-UNIT ABUTMENT

Angulation	Indication	Gingival Height (mm)	Narrow NP	Standard SP
0°		1.5	IPD/TC-MN-01	IPD/TB-MR-01
		2.5	IPD/TC-MN-02	IPD/TB-MR-02
		3.5	IPD/TC-MN-03	IPD/TB-MR-03
		4.5	-	IPD/TB-MR-04
17°		2.5	-	IPD/TB-MR-12
30°		3.5	-	IPD/TB-MR-33
	Replacement Screw for Angled MUA		-	IPD/KA-MT-08

Straight Multi-unit abutments can be used for single and multiple restorations. Please see page 206 for the Multi-unit system accessories.



MULTI-UNIT AP ABUTMENT **NEW**

*Check availability

Angulation	Indication	Gingival Height (mm)	Narrow NP	Standard SP
17°		2.5	IPD/TC-MN-12/AP	IPD/TB-MR-12/AP
		3.5	IPD/TC-MN-13/AP	IPD/TB-MR-13/AP
30°		3.5	IPD/TC-MN-33/AP	IPD/TB-MR-33/AP
		4.5	IPD/TC-MN-34/AP	IPD/TB-MR-34/AP
	Replacement Screw for Angled MUA AP		IPD/KA-MT-05/BLC	IPD/KA-MT-08/BLC

Please see page 206 for the Multi-unit system accessories.



ANALOGS

Type		Narrow NP	Standard SP
Standard		IPD/TC-AN-00	IPD/TB-AR-00
	Full set	IPD/TC-AN-90/3D	IPD/TB-AR-90/3D
Digital	Analog		
	Bottom Screw		
	Side Screw		



Co-Cr BASE ABUTMENT

		Narrow NP	Standard SP
Co-Cr Base for analogic workflow			
Indication	Angulation		
	0°	-	IPD/TB-BR-00
	15°	-	IPD/TB-BR-10
	25°	-	IPD/TB-BR-20
	0°	-	IPD/TB-BR-01
	15°	-	IPD/TB-BR-11
	25°	-	IPD/TB-BR-21
Co-Cr Base for digital workflow			
Indication	Angulation		
	Straight/ASC	-	IPD/TB-BR-00/3D
		-	IPD/TB-BR-01/3D
		-	IPD/SC-AN-B1
	Scan Body	-	IPD/SC-AN-B1

All ASC CoCr analogic workflow abutments include the relevant TPA screw.



PSD OVERDENTURE ABUTMENT

Indication	Gingival Height (mm)	Narrow NP	Standard SP
	1.0	IPD/TC-LN-01	IPD/TB-LR-01
	2.0	-	IPD/TB-LR-02
	3.0	IPD/TC-LN-03	IPD/TB-LR-03
	4.0	-	IPD/TB-LR-04
	5.0	IPD/TC-LN-05	IPD/TB-LR-05

Please see page 205 for the PSD system accessories.



TEMPORARY ABUTMENT / OPEN TRAY COPING

Indication	Gingival Height (mm)	Narrow NP	Standard SP
	1.5	IPD/TC-PN-06	IPD/TB-PR-06
	1.5	IPD/TC-PN-07	IPD/TB-PR-07
	Long coping screw	IPD/TB-TN-00/C	IPD/TB-TR-00/C

The same abutment can be used as a temporary abutment with the occlusal screw or as an impression coping using the coping screw.



HEALING ABUTMENT

Gingival Height (mm)	Head Diameter (mm)	Narrow NP	Standard SP
		ø4.0	ø4.0
2.0		-	IPD/TB-DR-02
3.0		IPD/TC-DN-03	IPD/TB-DR-03
4.0		IPD/TC-DN-04	IPD/TB-DR-04
5.0		IPD/TC-DN-05	IPD/TB-DR-05



SCREWDRIVERS

Type	Length (mm)	Narrow NP ●	Standard SP ●
Implant system Screwdriver			
1.25 Hex	18	IPD/PH-25-18	IPD/PH-25-18
	25	IPD/PH-25-25	IPD/PH-25-25
	32	IPD/PH-25-32	IPD/PH-25-32
IPD Scan Body and extra Screwdrivers			
1.20 Hex	18	IPD/PH-20-18	IPD/PH-20-18
	25	IPD/PH-20-25	IPD/PH-20-25
	32	IPD/PH-20-32	IPD/PH-20-32
ASC Screwdriver			
TPA	18	IPD/KA-CT-18	IPD/KA-CT-18
	25	IPD/KA-CT-25	IPD/KA-CT-25
	32	IPD/KA-CT-32	IPD/KA-CT-32
PSD Screwdriver			
PSD	25	IPD/LL-PS-00	IPD/LL-PS-00



ACCESSORIES

Indication	Length (mm)	Narrow NP ●	Standard SP ●
Clinical RA Shank Handle	16	IPD/MC-00-16	IPD/MC-00-16
Laboratory RA Shank Handle	70	IPD/ML-00-70	IPD/ML-00-70
RA Shank Ratchet	90	IPD/DI-00-90	IPD/DI-00-90
Ratchet adapter		IPD/DI-KA-90	IPD/DI-KA-90
PSD and insert extractor tool		IPD/LL-PS-01	IPD/LL-PS-01

Please see page 210 for more information.



DIO[®]

UB UFII[®]

Prosthetic platform [NP (N) / RP (R)]

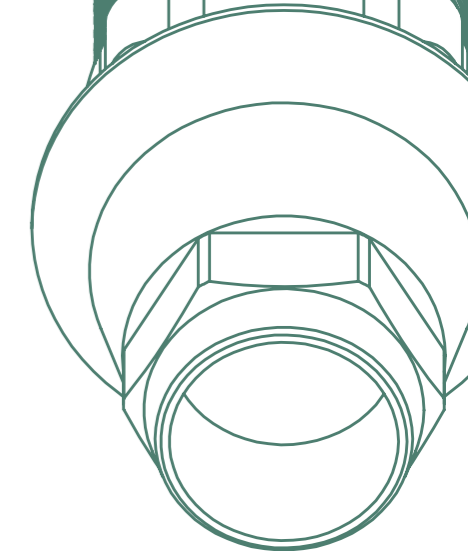

SCAN BODY

	Indication	Height (mm)	NP (N) ●	RP (R) ●
Scan Body		10	IPD/UB-SN-00	IPD/UB-SR-00
		15	IPD/UB-SN-02	IPD/UB-SR-02
		10	IPD/UB-SN-01	IPD/UB-SR-01

Captive screw included. 1.20 Hex Screwdriver.



Ti-BASE *ipd* Custom Ti-Base System[®]

Indication	Gingival Height (mm)	NP (N) ●	RP (R) ●
	1.0	IPD/UB-IN-00/3D	IPD/UB-IR-00/3D
	2.0	IPD/UB-IN-02/3D	IPD/UB-IR-02/3D
	3.0	IPD/UB-IN-04/3D	IPD/UB-IR-04/3D
Cutting guide KIT		IPD/KT-IN-00	IPD/KT-IR-00
	1.0	IPD/UB-IN-01/3D	IPD/UB-IR-01/3D
	2.0	IPD/UB-IN-03/3D	IPD/UB-IR-03/3D
	3.0	IPD/UB-IN-05/3D	IPD/UB-IR-05/3D
Cutting guide KIT		IPD/KT-IN-01	IPD/KT-IR-01

Please see page 204 for the IPD Custom Interface System accessories.



SCREWS

IPD and OEM compatible			NP (N) ●	RP (R) ●
Screwdriver	Coating	Torque value	20 Ncm	30 Ncm
1.20 Hex	-	Conical	IPD/UB-TN-00	IPD/UB-TR-00
1.20 Hex	TiN	Conical	IPD/UB-TN-00/TiN	IPD/UB-TR-00/TiN
1.20 Hex	BLC	Conical	IPD/UB-TN-00/BLC	IPD/UB-TR-00/BLC
For ASC options			20 Ncm	25 Ncm
Screwdriver	Coating	Torque value	20 Ncm	25 Ncm
TPA	TiN	Conical	IPD/UB-TN-50	IPD/UB-TR-50



[RETURN TO INDEX](#)

MULTI-UNIT ABUTMENT

Angulation	Indication	Gingival Height (mm)	NP (N) ●	RP (R) ●
0°		1.5	IPD/UB-MN-01	IPD/UB-MR-01
		2.5	IPD/UB-MN-02	IPD/UB-MR-02
		3.5	IPD/UB-MN-03	IPD/UB-MR-03
17°		2.5	IPD/UB-MN-12	IPD/UB-MR-12
30°		3.5	IPD/UB-MN-33	IPD/UB-MR-33
Replacement Screw for Angled MUA			IPD/KA-MT-12	IPD/KA-MT-03

Straight Multi-unit abutments can be used for single and multiple restorations. Please see page 206 for the Multi-unit system accessories.





ANALOGS

Type		NP (N) ●	RP (R) ●
Standard		IPD/UB-AN-00	IPD/UB-AR-00
	Full set	IPD/UB-AN-90/3D	IPD/UB-AR-90/3D
Digital	Analog		
	Bottom Screw		
	Side Screw		



Co-Cr BASE ABUTMENT

		NP (N) ●	RP (R) ●
Co-Cr Base for analogic workflow			
Indication	Angulation		
	0°	IPD/UB-BN-00	IPD/UB-BR-00
	15°	IPD/UB-BN-10	-
	0°	IPD/UB-BN-01	IPD/UB-BR-01
	15°	IPD/UB-BN-11	-
Co-Cr Base for digital workflow			
Indication	Angulation		
	Straight/ASC	IPD/UB-BN-00/3D	IPD/UB-BR-00/3D
		IPD/UB-BN-01/3D	IPD/UB-BR-01/3D
Scan Body		IPD/SC-AN-B1	IPD/SC-AN-B1

All ASC CoCr analogic workflow abutments include the relevant TPA screw.





PSD OVERDENTURE ABUTMENT

Indication	Gingival Height (mm)	NP (N) ●	RP (R) ●
	2.0	IPD/UB-LN-02	IPD/UB-LR-02
	3.0	IPD/UB-LN-03	IPD/UB-LR-03
	4.0	IPD/UB-LN-04	IPD/UB-LR-04

Please see page 205 for the PSD system accessories.



TEMPORARY ABUTMENT / OPEN TRAY COPING

Indication	Gingival Height (mm)	NP (N) ●	RP (R) ●
	1.5	IPD/UB-PN-06	IPD/UB-PR-06
	1.5	IPD/UB-PN-07	IPD/UB-PR-07
Long coping screw		IPD/UB-TN-00/C	IPD/UB-TR-00/C

The same abutment can be used as a temporary abutment with the occlusal screw or as an impression coping using the coping screw.



HEALING ABUTMENT

Gingival Height (mm)	Head Diameter (mm)	NP (N) ●	RP (R) ●
		ø4.2	ø4.6
2.0		IPD/UB-DN-02	IPD/UB-DR-02
3.5		IPD/UB-DN-03	IPD/UB-DR-03
5.0		IPD/UB-DN-05	IPD/UB-DR-05



SCREWDRIVERS

Type	Length (mm)	NP (N) ●	RP (R) ●
Implant system Screwdriver			
IPD Scan Body and extra Screwdrivers			
1.20 Hex	18	IPD/PH-20-18	IPD/PH-20-18
	25	IPD/PH-20-25	IPD/PH-20-25
	32	IPD/PH-20-32	IPD/PH-20-32
ASC Screwdriver			
TPA	18	IPD/KA-CT-18	IPD/KA-CT-18
	25	IPD/KA-CT-25	IPD/KA-CT-25
	32	IPD/KA-CT-32	IPD/KA-CT-32
PSD Screwdriver			
PSD	25	IPD/LL-PS-00	IPD/LL-PS-00



ACCESSORIES

Indication	Length (mm)	NP (N) ●	RP (R) ●
Clinical RA Shank Handle	16	IPD/MC-00-16	IPD/MC-00-16
Laboratory RA Shank Handle	70	IPD/ML-00-70	IPD/ML-00-70
RA Shank Ratchet	90	IPD/DI-00-90	IPD/DI-00-90
Ratchet adapter		IPD/DI-KA-90	IPD/DI-KA-90
PSD and insert extractor tool		IPD/LL-PS-01	IPD/LL-PS-01

Please see page 210 for more information.



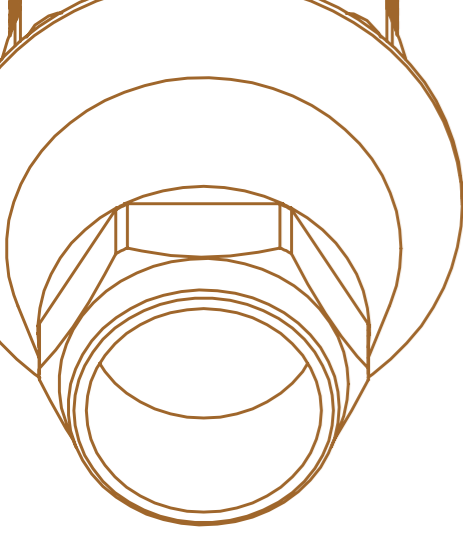

MEGAGEN®

WA ANYONE®

Prosthetic platform [RP]

*Digital line not suitable for ø3.5mm implant diameter

SCAN BODY

Indication	Height (mm)	RP
Scan Body	10	IPD/WA-SR-00
	15	IPD/WA-SR-02
	10	IPD/WA-SR-01

Captive screw included. 1.20 Hex Screwdriver.



Ti-BASE ipd Custom Ti-Base System®

Indication	Gingival Height (mm)	RP
Single tooth	1.0	IPD/WA-IR-00/3D
	2.0	IPD/WA-IR-02/3D
	3.0	IPD/WA-IR-04/3D
Cutting guide KIT		IPD/KT-IR-00
Full arch	1.0	IPD/WA-IR-01/3D
	2.0	IPD/WA-IR-03/3D
	3.0	IPD/WA-IR-05/3D
Cutting guide KIT		IPD/KT-IR-01

Please see page 204 for the IPD Custom Interface System accessories.



IPDMILLED SYSTEM* NEW

*Check availability

Indication	Material	Diameter (mm)	RP
TYPE A System (Compatible with DESS® Holders)			
	Ti	15	PR/WA-XR-15/A

All premilled abutments include 2 titanium screws.

SCREWS

IPD and OEM compatible	For straight channels	Torque value	RP
Screwdriver	Coating	Seat	
1.20 Hex	-	Conical	IPD/WA-TR-00
1.20 Hex	TiN	Conical	IPD/WA-TR-00/TiN
1.20 Hex	BLC	Conical	IPD/WA-TR-00/BLC
For ASC options		Torque value	25 Ncm
Screwdriver	Coating	Seat	
TPA	TiN	Conical	IPD/WA-TR-50



[RETURN TO INDEX](#)

MULTI-UNIT ABUTMENT

Angulation	Indication	Gingival Height (mm)	RP
0°	[Diagram]	1.5	IPD/WA-MR-01
		2.5	IPD/WA-MR-02
		3.5	IPD/WA-MR-03
17°	[Diagram]	2.5	IPD/WA-MR-12
30°	[Diagram]	3.5	IPD/WA-MR-33
Replacement Screw for Angled MUA			IPD/KA-MT-13

Straight Multi-unit abutments can be used for single and multiple restorations. Please see page 206 for the Multi-unit system accessories.



ANALOGS

Type	RP
Standard	IPD/WA-AR-00
Full set	IPD/WA-AR-90/3D
Digital	Analog Bottom Screw Side Screw



Co-Cr BASE ABUTMENT

Co-Cr Base for analogic workflow		RP
Indication	Angulation	
Single tooth	0°	IPD/WA-BR-00
Full arch		IPD/WA-BR-01
Co-Cr Base for digital workflow		
Indication	Angulation	
Single tooth	Straight	IPD/WA-BR-00/3D
Full arch		IPD/WA-BR-01/3D
Scan Body		IPD/SC-AN-B1



PSD OVERDENTURE ABUTMENT

Indication	Gingival Height (mm)	RP
[Diagram]	2.0	IPD/WA-LR-02
	3.0	IPD/WA-LR-03
	4.0	IPD/WA-LR-04
	5.0	IPD/WA-LR-05

Please see page 205 for the PSD system accessories.



TEMPORARY ABUTMENT / OPEN TRAY COPING

Indication	Gingival Height (mm)	RP
Single tooth	1.5	IPD/WA-PR-06
Full arch	1.5	IPD/WA-PR-07
Long coping screw		IPD/WA-TR-00/C

The same abutment can be used as a temporary abutment with the occlusal screw or as an impression coping using the coping screw.



HEALING ABUTMENT

Gingival Height (mm)	Head Diameter (mm)	RP ●
3.0	φ 4.5	IPD/WA-DR-03
5.0		IPD/WA-DR-05
7.0		IPD/WA-DR-07



SCREWDRIVERS

Type	Length (mm)	RP ●
Implant system Screwdriver		
IPD Scan Body and extra Screwdrivers		
1.20 Hex	18	IPD/PH-20-18
	25	IPD/PH-20-25
	32	IPD/PH-20-32
ASC Screwdriver		
TPA	18	IPD/KA-CT-18
	25	IPD/KA-CT-25
	32	IPD/KA-CT-32
PSD Screwdriver		
PSD	25	IPD/LL-PS-00



ACCESSORIES

Indication	Length (mm)	RP ●
Clinical RA Shank Handle	16	IPD/MC-00-16
Laboratory RA Shank Handle	70	IPD/ML-00-70
RA Shank Ratchet	90	IPD/DI-00-90
Ratchet adapter		IPD/DI-KA-90
PSD and insert extractor		IPD/LL-PS-01



Please see page 210 for more information.

MEGAGEN®

WB ANYRIDGE® Prosthetic platform [φ4.0]

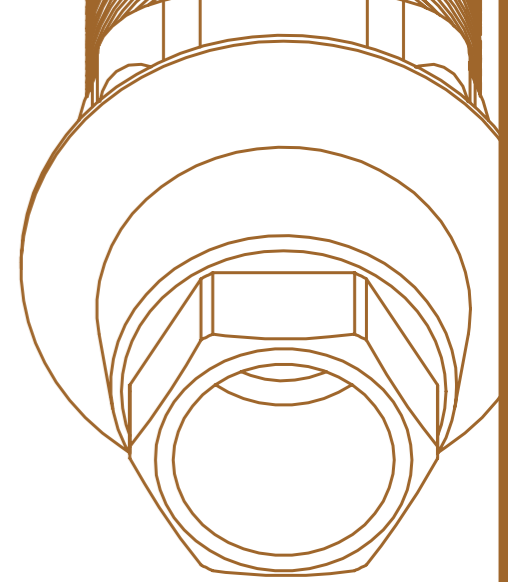

SCAN BODY

Indication	Height (mm)	φ4.0
Scan Body	10	IPD/WB-SR-00
	15	IPD/WB-SR-02
	10	IPD/WB-SR-01

Captive screw included. 1.20 Hex Screwdriver.



Ti-BASE Custom Ti-Base System®

Indication	Gingival Height (mm)	φ4.0
Scan Body	1.0	IPD/WB-IR-00/3D
	2.0	IPD/WB-IR-02/3D
	3.0	IPD/WB-IR-04/3D
Cutting guide KIT		IPD/KT-IR-00
Scan Body	1.0	IPD/WB-IR-01/3D
	2.0	IPD/WB-IR-03/3D
	3.0	IPD/WB-IR-05/3D
Cutting guide KIT		IPD/KT-IR-01

Please see page 204 for the IPD Custom Interface System accessories.



IPDMILLED SYSTEM*

*Check availability

Indication	Material	Diameter (mm)	φ4.0
IPD Blank System (Compatible with NT/IPD Holders)			
Mill Analog	Ti	12	IPD/WB-XR-00
			IPD/WB-AR-00/X
TYPE A System (Compatible with DESS® Holders)			
	Ti	15	PR/WB-XR-15/A

All premilled abutments include 2 titanium screws.







SCREWS

Indication	Coating	Torque value	φ4.0
IPD and OEM compatible			
		25 Ncm	
Screwdriver			
1.20 Hex	-	Flat	IPD/WB-TR-00
1.20 Hex	TiN	Flat	IPD/WB-TR-00/TiN
1.20 Hex	BLC	Flat	IPD/WB-TR-00/BLC
Removing tool			
		Flat	IPD/WB-TR-01



[RETURN TO INDEX](#)

MULTI-UNIT ABUTMENT





Angulation	Indication	Gingival Height (mm)	Ø4.0
0°		1.5	IPD/WB-MR-01
		2.5	IPD/WB-MR-02
		3.5	IPD/WB-MR-03
17°		2.5	IPD/WB-MR-12
30°		3.5	IPD/WB-MR-33
Replacement Screw for Angled MUA			IPD/KA-MT-07

Straight Multi-unit abutments can be used for single and multiple restorations. Please see page 206 for the Multi-unit system accessories.

ANALOGS

Type	Ø4.0
Standard	IPD/WB-AR-00
	Full set IPD/WB-AR-90/3D
Digital	Analog Bottom Screw Side Screw

Co-Cr BASE ABUTMENT



Co-Cr Base for analogic workflow		Ø4.0
Indication	Angulation	
	0°	IPD/WB-BR-00
		IPD/WB-BR-01
Co-Cr Base for digital workflow		
Indication	Angulation	
	Straight	IPD/WB-BR-00/3D
		IPD/WB-BR-01/3D
Scan Body		IPD/SC-AN-B1

PSD OVERDENTURE ABUTMENT

Indication	Gingival Height (mm)	Ø4.0
	2.0	IPD/WB-LR-02
	3.0	IPD/WB-LR-03
	4.0	IPD/WB-LR-04
	5.0	IPD/WB-LR-05

Please see page 205 for the PSD system accessories.

TEMPORARY ABUTMENT / OPEN TRAY COPING

Indication	Gingival Height (mm)	Ø4.0
	1.5	IPD/WB-PR-06
	1.5	IPD/WB-PR-07
Long coping screw		IPD/WB-TR-00/C

The same abutment can be used as a temporary abutment with the occlusal screw or as an impression coping using the coping screw.



HEALING ABUTMENT

Gingival Height (mm)	Ø4.0
Head Diameter (mm)	
1.5	IPD/WB-DR-01
3.0	IPD/WB-DR-03
5.0	IPD/WB-DR-05



SCREWDRIVERS

Type	Length (mm)	Ø4.0
Implant system Screwdriver		
IPD Scan Body and extra Screwdrivers		
1.20 Hex	18	IPD/PH-20-18
	25	IPD/PH-20-25
	32	IPD/PH-20-32
PSD Screwdriver		
PSD	25	IPD/LL-PS-00



ACCESSORIES

Indication	Length (mm)	Ø4.0
Clinical RA Shank Handle	16	IPD/MC-00-16
Laboratory RA Shank Handle	70	IPD/ML-00-70
RA Shank Ratchet	90	IPD/DI-00-90
Ratchet adapter	-	IPD/DI-KA-90
PSD and insert extractor	-	IPD/LL-PS-01

Please see page 210 for more information.



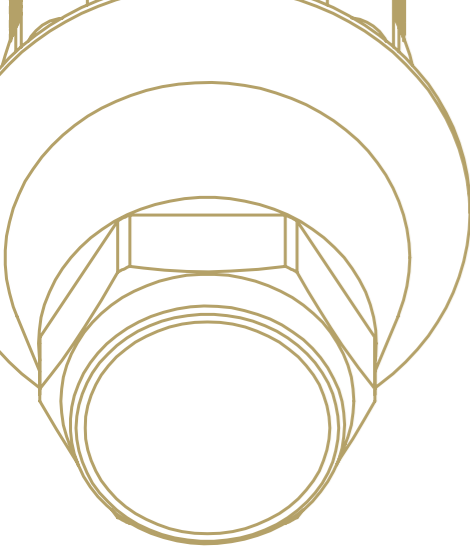

DENTIUM®

XA IMPLANTIUM® / SUPERLINE™

Prosthetic platform [RP]

SCAN BODY

	Indication	Height (mm)	RP
Scan Body		10	IPD/XA-SR-00
		15	IPD/XA-SR-02
		10	IPD/XA-SR-01

Captive screw included. 1.20 Hex Screwdriver.

Ti-BASE Custom Ti-Base System®

Indication	Gingival Height (mm)	RP
	1.0	IPD/XA-IR-00/3D
	2.0	IPD/XA-IR-02/3D
	3.0	IPD/XA-IR-04/3D
	Cutting guide KIT	IPD/KT-IR-00
	1.0	IPD/XA-IR-01/3D
	2.0	IPD/XA-IR-03/3D
	3.0	IPD/XA-IR-05/3D
	Cutting guide KIT	IPD/KT-IR-01

Please see page 204 for the IPD Custom Interface System accessories.

IPDMILLED SYSTEM*

*Check availability

Indication	Material	Diameter (mm)	RP
IPD Blank System (Compatible with NT/IPD Holders)			
	Ti	12	IPD/XA-XR-00
			IPD/XA-AR-00/X
TYPE A System (Compatible with DESS® Holders)			
	Ti	15	PR/XA-XR-15/A

All premilled abutments include 2 titanium screws.

SCREWS

			RP
IPD and OEM compatible	For straight channels	Torque value	25Ncm
Screwdriver	Coating	Seat	
1.27 Hex	-	Conical	IPD/XA-TR-00
1.27 Hex	TiN	Conical	IPD/XA-TR-00/TiN
1.27 Hex	BLC	Conical	IPD/XA-TR-00/BLC
	For ASC options	Torque value	25Ncm
Screwdriver	Coating	Seat	
TPA	TiN	Conical	IPD/XA-TR-50



RETURN TO INDEX

MULTI-UNIT ABUTMENT

Angulation	Indication	Gingival Height (mm)	RP
0°		1.5	IPD/XA-MR-01
		2.5	IPD/XA-MR-02
		3.5	IPD/XA-MR-03
17°		2.5	IPD/XA-MR-12
30°		3.5	IPD/XA-MR-33
		Replacement Screw for Angled MUA	IPD/KA-MT-13



Straight Multi-unit abutments can be used for single and multiple restorations. Please see page 206 for the Multi-unit system accessories.

ANALOGS

Type	RP
Standard	IPD/XA-AR-00
	Full set
	IPD/XA-AR-90/3D
Digital	Analog
	Bottom Screw
	Side Screw



Co-Cr BASE ABUTMENT

		RP
Co-Cr Base for analogic workflow		
Indication	Angulation	
	0°	IPD/XA-BR-00
	0°	IPD/XA-BR-01
Co-Cr Base for digital workflow		
Indication	Angulation	
	Straight / ASC	IPD/XA-BR-00/3D
	Straight / ASC	IPD/XA-BR-01/3D
	Scan Body	IPD/SC-AN-B1



PSD OVERDENTURE ABUTMENT

Indication	Gingival Height (mm)	RP
	2.0	IPD/XA-LR-02
	3.0	IPD/XA-LR-03
	4.0	IPD/XA-LR-04
	5.0	IPD/XA-LR-05



Please see page 205 for the PSD system accessories.

TEMPORARY ABUTMENT / OPEN TRAY COPING

Indication	Gingival Height (mm)	RP
	1.5	IPD/XA-PR-06
	1.5	IPD/XA-PR-07
	Long coping screw	IPD/XA-TR-00/C



The same abutment can be used as a temporary abutment with the occlusal screw or as an impression coping using the coping screw.

HEALING ABUTMENT

Gingival Height (mm)	RP
	Head Diameter (mm)
2.0	IPD/XA-DR-02
3.5	IPD/XA-DR-03
5.0	IPD/XA-DR-05



SCREWDRIVERS

Type	Length (mm)	RP
Implant system Screwdriver		
	18	IPD/PH-27-18
1.27 Hex	25	IPD/PH-27-25
	32	IPD/PH-27-32
IPD Scan Body and extra Screwdrivers		
	18	IPD/PH-20-18
1.20 Hex	25	IPD/PH-20-25
	32	IPD/PH-20-32
ASC Screwdriver		
	18	IPD/KA-CT-18
TPA	25	IPD/KA-CT-25
	32	IPD/KA-CT-32
PSD Screwdriver		
PSD	25	IPD/LL-PS-00



ACCESSORIES

Indication	Length (mm)	RP
Clinical RA Shank Handle	16	IPD/MC-00-16
Laboratory RA Shank Handle	70	IPD/ML-00-70
RA Shank Ratchet	90	IPD/DI-00-90
Ratchet adapter		IPD/DI-KA-90
PSD and insert extractor		IPD/LL-PS-01

Please see page 210 for more information.



MEDENTIS®

YB ICX Prosthetic platform [RP]

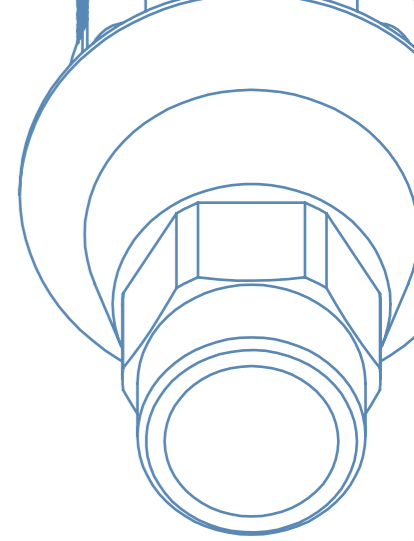

SCAN BODY

Indication	Height (mm)	RP
Scan Body	10	IPD/YB-SR-00
	15	IPD/YB-SR-02
	10	IPD/YB-SR-01

Captive screw included. 1.20 Hex Screwdriver.



Ti-BASE ipd Custom Ti-Base System®

Indication	Gingival Height (mm)	RP
Single crown	1.0	IPD/YB-IR-00/3D
	2.0	IPD/YB-IR-02/3D
	3.0	IPD/YB-IR-04/3D
Cutting guide KIT		IPD/KT-IR-00
Full arch	1.0	IPD/YB-IR-01/3D
	2.0	IPD/YB-IR-03/3D
	3.0	IPD/YB-IR-05/3D
Cutting guide KIT		IPD/KT-IR-01

Please see page 204 for the IPD Custom Interface System accessories.



IPDMILLED SYSTEM* NEW

*Check availability

Indication	Material	Diameter (mm)	RP
IPD Blank System (Compatible with NT/IPD Holders)			
	Ti	12	IPD/YB-XR-00
Mill Analog			IPD/YB-AR-00/X
TYPE A System (Compatible with DESS® Holders)			
	Ti	15	PR/YB-XR-15/A

All premilled abutments include 2 titanium screws.







SCREWS

Indication	Coating	Seat	Torque value	RP
IPD and OEM compatible For straight channels				
				30 Ncm
Screwdriver	Coating	Seat		
1.40 Hex	-	Conical		IPD/YB-TR-00
1.40 Hex	TiN	Conical		IPD/YB-TR-00/TiN
1.40 Hex	BLC	Conical		IPD/YB-TR-00/BLC
For ASC options				
				20 Ncm
Screwdriver	Coating	Seat		
TPA	TiN	Conical		IPD/YB-TR-50



[RETURN TO INDEX](#)

MULTI-UNIT ABUTMENT

Angulation	Indication	Gingival Height (mm)	RP
0°		1.5	IPD/YB-MR-01
		2.5	IPD/YB-MR-02
		3.5	IPD/YB-MR-03
17°		2.5	IPD/YB-MR-12
30°		3.5	IPD/YB-MR-33
Replacement Screw for Angled MUA			IPD/KA-MT-02

Straight Multi-unit abutments can be used for single and multiple restorations. Please see page 206 for the Multi-unit system accessories.







ANALOGS

Type	RP
Standard	IPD/YB-AR-00
Full set	IPD/YB-AR-90/3D
Digital	Analog Bottom Screw Side Screw



Co-Cr BASE ABUTMENT

Indication	Angulation	RP
Co-Cr Base for analogic workflow		
	0°	IPD/YB-BR-00
	15°	IPD/YB-BR-10
	25°	IPD/YB-BR-20
	0°	IPD/YB-BR-01
	15°	IPD/YB-BR-11
	25°	IPD/YB-BR-21
Co-Cr Base for digital workflow		
	Straight / ASC	IPD/YB-BR-00/3D
		Straight / ASC
Scan Body		IPD/SC-AN-B1

All ASC CoCr analogic workflow abutments include the relevant TPA screw.





PSD OVERDENTURE ABUTMENT

Indication	Gingival Height (mm)	RP
	2.0	IPD/YB-LR-02
	3.0	IPD/YB-LR-03
	4.0	IPD/YB-LR-04
	5.0	IPD/YB-LR-05

Please see page 205 for the PSD system accessories.



TEMPORARY ABUTMENT / OPEN TRAY COPING

Indication	Gingival Height (mm)	RP
	1.5	IPD/YB-PR-06
	1.5	IPD/YB-PR-07
Long coping screw		IPD/YB-TR-00/C

The same abutment can be used as a temporary abutment with the occlusal screw or as an impression coping using the coping screw.



HEALING ABUTMENT

Gingival Height (mm)	Head Diameter (mm)	RP
1.0	ø4.7	IPD/YB-DR-01
2.5		IPD/YB-DR-02
4.0		IPD/YB-DR-04



SCREWDRIVERS

Type	Length (mm)	RP
Implant system Screwdriver		
1.40 Hex	18	IPD/PH-40-18
	25	IPD/PH-40-25
	32	IPD/PH-40-32
IPD Scan Body and extra Screwdrivers		
1.20 Hex	18	IPD/PH-20-18
	25	IPD/PH-20-25
	32	IPD/PH-20-32
ASC Screwdriver		
TPA	18	IPD/KA-CT-18
	25	IPD/KA-CT-25
	32	IPD/KA-CT-32
PSD Screwdriver		
PSD	25	IPD/LL-PS-00



ACCESSORIES

Indication	Length (mm)	RP
Clinical RA Shank Handle	16	IPD/MC-00-16
Laboratory RA Shank Handle	70	IPD/ML-00-70
RA Shank Ratchet	90	IPD/DI-00-90
Ratchet adapter		IPD/DI-KA-90
PSD and insert extractor		IPD/LL-PS-01

Please see page 210 for more information.



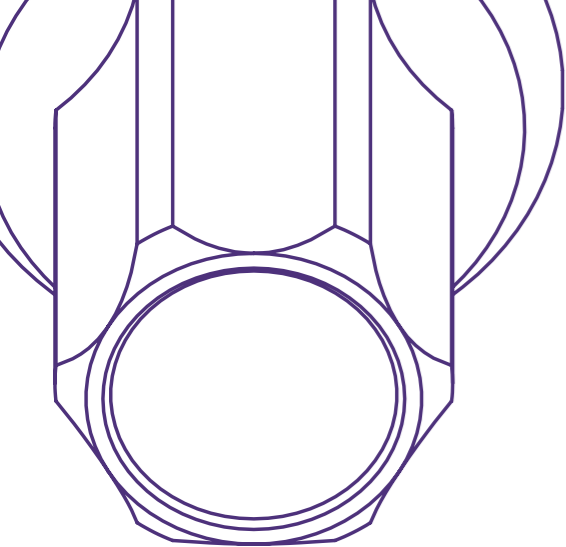

BREDENT®

ZA BLUE SKY®

Prosthetic platform [Ø3.5 / Ø4.0]

SCAN BODY

	Indication	Height (mm)	Ø3.5	Ø4.0
Scan Body		10	IPD/ZA-SR-00	IPD/ZA-SR-00

Captive screw included. 1.20 Hex Screwdriver.

IPDMILLED SYSTEM*

*Check availability

Indication	Material	Diameter (mm)	Ø3.5	Ø4.0
IPD Blank System (Compatible with NT/IPD Holders)				
	Ti	12	IPD/ZA-XN-00	IPD/ZA-XR-00
Mill Analog			IPD/ZA-AR-00/X	IPD/ZA-AR-00/X
TYPE A System (Compatible with DESS® Holders)				
	Ti	10	PR/ZA-XN-10/A	PR/ZA-XR-10/A
	Ti	15	PR/ZA-XR-15/A	PR/ZA-XR-15/A

All premilled abutments include 2 titanium screws.

SCREWS

			Ø3.5	Ø4.0
IPD and OEM compatible	For straight channels	Torque value		25Ncm
Screwdriver	Coating	Seat		
Uni-Bredent	-	Conical	IPD/ZA-TR-00	IPD/ZA-TR-00

SCREWDRIVERS

Type	Length (mm)	Ø3.5	Ø4.0
Implant system Screwdriver			
IPD Scan Body and extra Screwdrivers			
	18	IPD/PH-20-18	IPD/PH-20-18
1.20 Hex	25	IPD/PH-20-25	IPD/PH-20-25
	32	IPD/PH-20-32	IPD/PH-20-32

ACCESSORIES

Indication	Length (mm)	Ø3.5	Ø4.0
Clinical RA Shank Handle	16	IPD/MC-00-16	IPD/MC-00-16
Laboratory RA Shank Handle	70	IPD/ML-00-70	IPD/ML-00-70
RA Shank Ratchet	90	IPD/DI-00-90	IPD/DI-00-90
Ratchet adapter		IPD/DI-KA-90	IPD/DI-KA-90

Please see page 210 for more information.



[RETURN TO INDEX](#)

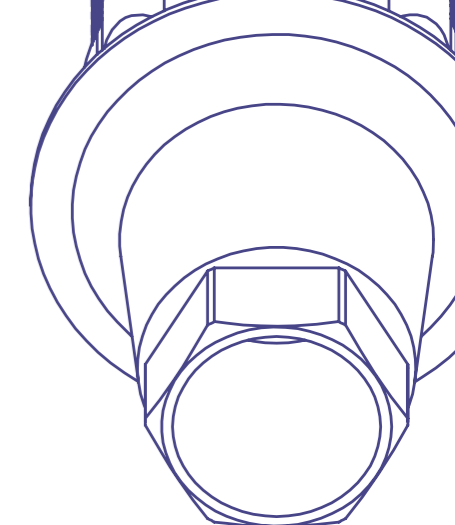

GLOBAL D®

1A IN-KONE®

Prosthetic platform [RP]

SCAN BODY

	Indication	Height (mm)	RP
Scan Body		10	IPD/1A-SR-00
		15	IPD/1A-SR-02
		10	IPD/1A-SR-01

Captive screw included. 1.20 Hex Screwdriver.



Ti-BASE

Indication	Gingival Height (mm)	RP
	1.0	IPD/1A-IR-00/3D
	2.0	IPD/1A-IR-02/3D
	3.0	IPD/1A-IR-04/3D
Cutting guide KIT		IPD/KT-IR-00
	1.0	IPD/1A-IR-01/3D
	2.0	IPD/1A-IR-03/3D
	3.0	IPD/1A-IR-05/3D
Cutting guide KIT		IPD/KT-IR-01

Please see page 204 for the IPD Custom Interface System accessories.



IPDMILLED SYSTEM*

*Check availability

Indication	Material	Diameter (mm)	RP
TYPE A System (Compatible with DESS® Holders)			
	Ti	15	PR/1A-XR-15/A

All premilled abutments include 2 titanium screws.

SCREWS

			RP
IPD and OEM compatible	For straight channels	Torque value	15 Ncm
Screwdriver	Coating	Seat	
1.20 Hex	-	Conical	IPD/1A-TR-00
1.20 Hex	TiN	Conical	IPD/1A-TR-00/TiN
1.20 Hex	BLC	Conical	IPD/1A-TR-00/BLC
Removing tool		Conical	IPD/1A-TR-01



[RETURN TO INDEX](#)



MULTI-UNIT ABUTMENT

Angulation	Indication	Gingival Height (mm)	RP
0°		1.5	IPD/1A-MR-01
		2.5	IPD/1A-MR-02
		3.5	IPD/1A-MR-03

Straight Multi-unit abutments can be used for single and multiple restorations. Please see page 206 for the Multi-unit system accessories.

MULTI-UNIT AP ABUTMENT* NEW

*Check availability





Angulation	Indication	Gingival Height (mm)	RP
17°		3.0	IPD/1A-MR-13/AP
		4.0	IPD/1A-MR-14/AP
30°		3.0	IPD/1A-MR-33/AP
		4.0	IPD/1A-MR-34/AP
Replacement Screw for Angled MUA AP			IPD/KA-MT-08/BLC

Please see page 206 for the Multi-unit system accessories.

ANALOGS

Type	RP
Standard	IPD/1A-AR-00
Full set	IPD/1A-AR-90/3D
Digital	Analog Bottom Screw Side Screw

Co-Cr BASE ABUTMENT

Co-Cr Base for analogic workflow			RP
Indication	Angulation		
	0°		IPD/1A-BR-00
		IPD/1A-BR-01	
Co-Cr Base for digital workflow			
Indication	Angulation		
	Straight		IPD/1A-BR-00/3D
		IPD/1A-BR-01/3D	
Scan Body			IPD/SC-AN-B1



PSD OVERDENTURE ABUTMENT

Indication	Gingival Height (mm)	RP
	2.0	IPD/1A-LR-02
	3.0	IPD/1A-LR-03
	4.0	IPD/1A-LR-04
	5.0	IPD/1A-LR-05

Please see page 205 for the PSD system accessories.



TEMPORARY ABUTMENT / OPEN TRAY COPING

Indication	Gingival Height (mm)	RP
	1.5	IPD/1A-PR-06
	1.5	IPD/1A-PR-07
Long coping screw		IPD/1A-TR-00/C

The same abutment can be used as a temporary abutment with the occlusal screw or as an impression coping using the coping screw.



HEALING ABUTMENT

Gingival Height (mm)	Head Diameter (mm)	RP
1.5	ø 4.4	IPD/1A-DR-01
3.0		IPD/1A-DR-03
4.5		IPD/1A-DR-04



SCREWDRIVERS

Type	Length (mm)	RP
Implant system Screwdriver		
IPD Scan Body and extra Screwdrivers		
1.20 Hex	18	IPD/PH-20-18
	25	IPD/PH-20-25
	32	IPD/PH-20-32
PSD Screwdriver		
PSD	25	IPD/LL-PS-00



ACCESSORIES

Indication	Length (mm)	RP
Clinical RA Shank Handle	16	IPD/MC-00-16
Laboratory RA Shank Handle	70	IPD/ML-00-70
RA Shank Ratchet	90	IPD/DI-00-90
Ratchet adapter		IPD/DI-KA-90
PSD and insert extractor		IPD/LL-PS-01

Please see page 210 for more information.



ANTHOGYR®

2A AXIOM® BL Prosthetic platform [RP]

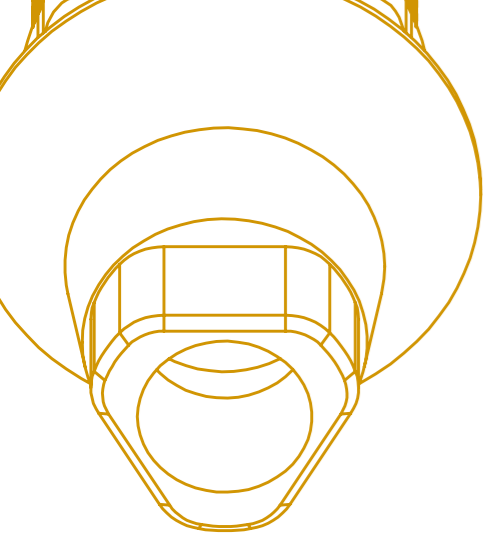

SCAN BODY

	Indication	Height (mm)	RP
Scan Body		10	IPD/2A-SR-00
		15	IPD/2A-SR-02
		10	IPD/2A-SR-01

Captive screw included. 1.20 Hex Screwdriver.

Ti-BASE Custom Ti-Base System®

Indication	Gingival Height (mm)	RP
	1.5	IPD/2A-IR-02/3D
	2.5	IPD/2A-IR-04/3D
	3.5	IPD/2A-IR-06/3D
	Cutting guide KIT	IPD/KT-IR-00
	1.5	IPD/2A-IR-03/3D
	2.5	IPD/2A-IR-05/3D
	3.5	IPD/2A-IR-07/3D
	Cutting guide KIT	IPD/KT-IR-01

Please see page 204 for the IPD Custom Interface System accessories.

IPDMILLED SYSTEM*

*Check availability

Indication	Material	Diameter (mm)	RP
TYPE A System (Compatible with DESS® Holders)	Ti	15	PR/2A-XR-15/A

All premilled abutments include 2 titanium screws.

SCREWS

IPD and OEM compatible	For straight channels	Torque value	RP
Screwdriver	Coating	Seat	
1.18 Hex	-	Conical	IPD/2A-TR-00
1.18 Hex	TiN	Conical	IPD/2A-TR-00/TiN
1.18 Hex	BLC	Conical	IPD/2A-TR-00/BLC
Removing tool		Conical	IPD/2A-TR-01



[RETURN TO INDEX](#)

MULTI-UNIT ABUTMENT

Angulation	Indication	Gingival Height (mm)	RP
0°		1.5	IPD/2A-MR-01
		2.5	IPD/2A-MR-02
		3.5	IPD/2A-MR-03

Straight Multi-unit abutments can be used for single and multiple restorations. Please see page 206 for the Multi-unit system accessories.



MULTI-UNIT AP ABUTMENT*

*Check availability

Angulation	Indication	Gingival Height (mm)	RP
17°		2.5	IPD/2A-MR-12/AP
		3.5	IPD/2A-MR-13/AP
30°		3.5	IPD/2A-MR-33/AP
		4.5	IPD/2A-MR-34/AP
		Replacement Screw for Angled MUA AP	IPD/KA-MT-15/BLC

Please see page 206 for the Multi-unit system accessories.



ANALOGS

Type	RP
Standard	IPD/2A-AR-00
	Full set IPD/2A-AR-90/3D
Digital	Analog
	Bottom Screw
	Side Screw



Co-Cr BASE ABUTMENT

Co-Cr Base for analogic workflow	RP
Indication	Angulation
	0°
	IPD/2A-BR-00
	IPD/2A-BR-01
Co-Cr Base for digital workflow	
Indication	Angulation
	Straight
	IPD/2A-BR-00/3D
	IPD/2A-BR-01/3D
	Scan Body IPD/SC-AN-B1





PSD OVERDENTURE ABUTMENT

Indication	Gingival Height (mm)	RP
	2.0	IPD/2A-LR-02
	3.0	IPD/2A-LR-03
	4.0	IPD/2A-LR-04
	5.0	IPD/2A-LR-05

Please see page 205 for the PSD system accessories.



TEMPORARY ABUTMENT / OPEN TRAY COPING

Indication	Gingival Height (mm)	RP
	1.5	IPD/2A-PR-06
	1.5	IPD/2A-PR-07
Long coping screw		IPD/2A-TR-00/C

The same abutment can be used as a temporary abutment with the occlusal screw or as an impression coping using the coping screw.

HEALING ABUTMENT

Gingival Height (mm)	Head Diameter (mm)	RP
1.5	φ4.4	IPD/2A-DR-01
3.0		IPD/2A-DR-03
4.5		IPD/2A-DR-04

SCREWDRIVERS

Type	Length (mm)	RP
Implant system Screwdriver		
1.18 Hex	18	IPD/PH-18-18
	25	IPD/PH-18-25
	32	IPD/PH-18-32
IPD Scan Body and extra Screwdrivers		
1.20 Hex	18	IPD/PH-20-18
	25	IPD/PH-20-25
	32	IPD/PH-20-32
PSD Screwdriver		
PSD	25	IPD/LL-PS-00

ACCESSORIES

Indication	Length (mm)	RP
Clinical RA Shank Handle	16	IPD/MC-00-16
Laboratory RA Shank Handle	70	IPD/ML-00-70
RA Shank Ratchet	90	IPD/DI-00-90
Ratchet adapter		IPD/DI-KA-90
PSD and insert extractor		IPD/LL-PS-01

Please see page 210 for more information.



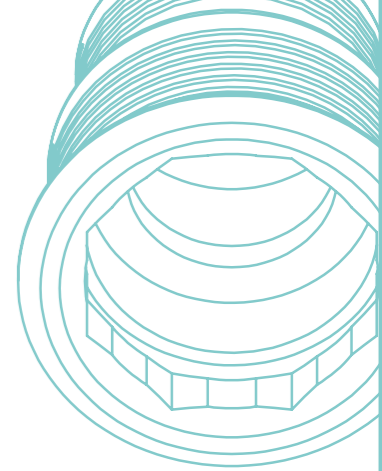

GALIMPLANT®

3A MULTI-POSICION AESTHETIC® Prosthetic platform [φ3.8]





SCAN BODY

	Indication	Height (mm)	φ3.8
Scan Body		10	IPD/3A-SR-00
		10	IPD/3A-SR-01

Captive screw included. 1.20 Hex Screwdriver.



Ti-BASE 

Indication	Post Height (mm)	Gingival Height (mm)	φ3.8
	4.15	0.2	IPD/3A-IR-00/3D
	6.5	0.2	IPD/3A-IR-02/3D
	4.15	0.2	IPD/3A-IR-01/3D
	6.5	0.2	IPD/3A-IR-03/3D



SCREWS

IPD and OEM compatible	For straight channels	Torque value	φ3.8
Screwdriver	Coating	Seat	
1.30 Hex	-	Conical	IPD/3A-TR-00
1.30 Hex	TiN	Conical	IPD/3A-TR-00/TiN
1.30 Hex	BLC	Conical	IPD/3A-TR-00/BLC

	For ASC options	Torque value	φ3.8
Screwdriver	Coating	Indication	
TPA	TiN	For PH 4.15 mm Ti-bases	IPD/3A-TR-50
TPA	TiN	For PH 6.5 mm Ti-bases	IPD/3A-TR-51





ANALOGS

Type	φ3.8
Standard	IPD/3A-AR-00
	Full set
	IPD/3A-AR-90/3D
Digital	Analog
	Bottom Screw
	Side Screw



RETURN TO INDEX

TEMPORARY ABUTMENT / OPEN TRAY COPING

Indication	Gingival Height (mm)	Ø3.8
	0.2	IPD/3A-PR-06
	0.2	IPD/3A-PR-07
Long coping screw		IPD/3A-TR-00/C

The same abutment can be used as a temporary abutment with the occlusal screw or as an impression coping using the coping screw.

HEALING ABUTMENT

Gingival Height (mm)	Head Diameter (mm)	Ø3.8
4.5		IPD/3A-DR-04
	Screw	IPD/3A-TR-00

Screw not included

SCREWDRIVERS

Type	Length (mm)	Ø3.8
Implant system Screwdriver		
	18	IPD/PH-30-18
1.30 Hex	25	IPD/PH-30-25
	32	IPD/PH-30-32
IPD Scan Body and extra Screwdrivers		
	18	IPD/PH-20-18
1.20 Hex	25	IPD/PH-20-25
	32	IPD/PH-20-32
ASC Screwdriver		
	18	IPD/KA-CT-18
TPA	25	IPD/KA-CT-25
	32	IPD/KA-CT-32

ACCESSORIES

Indication	Length (mm)	Ø3.8
Clinical RA Shank Handle	16	IPD/MC-00-16
Laboratory RA Shank Handle	70	IPD/ML-00-70
RA Shank Ratchet	90	IPD/DI-00-90
Ratchet adapter		IPD/DI-KA-90

Please see page 210 for more information.



NEOSS®

6A PROACTIVE® Prosthetic platform [NP / SP]

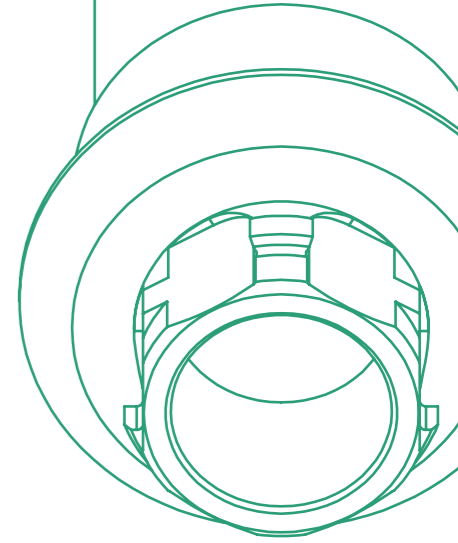

SCAN BODY

	Indication	Height (mm)	NP	SP
Scan Body		10	IPD/6A-ST-00	IPD/6A-SR-00

Captive screw included. 1.20 Hex Screwdriver.



IPDMILLED SYSTEM

Indication	Material	Diameter (mm)	NP	SP
IPD Blank System (Compatible with NT/IPD Holders)				
	Ti	12	IPD/6A-XT-00	IPD/6A-XR-00
Mill Analog			IPD/6A-AT-00/X	IPD/6A-AR-00/X
TYPE A System (Compatible with DESS® Holders)				
	Ti	15	-	PR/6A-XR-15/A

All premilled abutments include 2 titanium screws.



SCREWS

			NP	SP
IPD and OEM compatible	For straight channels	Torque value	15 Ncm	15 Ncm
Screwdriver	Coating	Seat		
Unigrip Neoss®	-	Conical	IPD/6A-TT-00	-
		Flat		IPD/6A-TR-00



SCREWDRIVERS

Type	Length (mm)	NP	SP
IPD Scan Body and extra Screwdrivers			
	18	IPD/PH-20-18	IPD/PH-20-18
1.20 Hex	25	IPD/PH-20-25	IPD/PH-20-25
	32	IPD/PH-20-32	IPD/PH-20-32



ACCESSORIES

Indication	Length (mm)	NP	SP
Clinical RA Shank Handle	16	IPD/MC-00-16	IPD/MC-00-16
Laboratory RA Shank Handle	70	IPD/ML-00-70	IPD/ML-00-70
RA Shank Ratchet	90	IPD/DI-00-90	IPD/DI-00-90
Ratchet adapter		IPD/DI-KA-90	IPD/DI-KA-90

Please see page 210 for more information.



[RETURN TO INDEX](#)

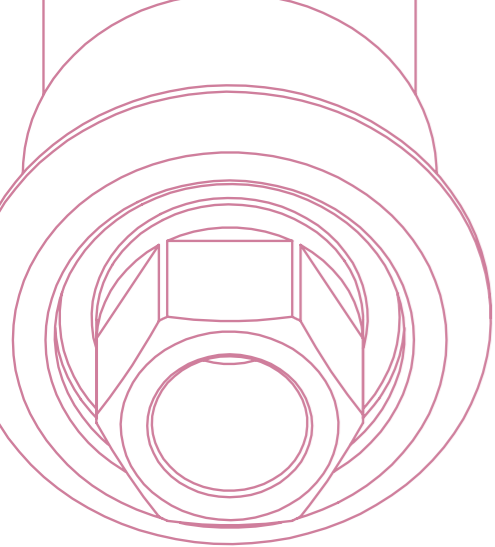

THOMMEN®

7A SPI®

Prosthetic platform [ø3.5 / ø4.0 / ø4.5 / ø5.0 / ø6.0]

SCAN BODY

Indication	Height (mm)	ø3.5	ø4.0	ø4.5	ø5.0	ø6.0
Scan Body 	10	IPD/7A-ST-00	IPD/7A-SN-00	IPD/7A-SR-00	IPD/7A-SW-00	IPD/7A-SX-00

Captive screw included. 1.20 Hex Screwdriver.



IPDMILLED SYSTEM

Indication	Material	Diameter (mm)	ø3.5	ø4.0	ø4.5	ø5.0	ø6.0
IPD Blank System (Compatible with NT/IPD Holders)							
	Ti	12	IPD/7A-XT-00	IPD/7A-XN-00	IPD/7A-XR-00	IPD/7A-XW-00	IPD/7A-XX-00
Mill Analog			IPD/7A-AT-00/X	IPD/7A-AN-00/X	IPD/7A-AR-00/X	IPD/7A-AW-00/X	IPD/7A-AX-00/X
TYPE A System (Compatible with DESS® Holders)							
	Ti	15	PR/7A-XT-15/A	PR/7A-XN-15/A	PR/7A-XR-15/A	PR/7A-XW-15/A	-

All premilled abutments include 2 titanium screws.



SCREWS

IPD and OEM compatible	For straight channels	Torque value	ø3.5	ø4.0	ø4.5	ø5.0	ø6.0
		15 Ncm					
		25 Ncm					
Screwdriver	Coating	Seat					
4 Lobes	-	Conical	IPD/7A-TN-00	IPD/7A-TR-00	IPD/7A-TR-00	IPD/7A-TR-00	IPD/7A-TR-00



SCREWDRIVERS

Type	Length (mm)	ø3.5	ø4.0	ø4.5	ø5.0	ø6.0
IPD Scan Body and extra Screwdrivers						
	18	IPD/PH-20-18	IPD/PH-20-18	IPD/PH-20-18	IPD/PH-20-18	IPD/PH-20-18
1.20 Hex	25	IPD/PH-20-25	IPD/PH-20-25	IPD/PH-20-25	IPD/PH-20-25	IPD/PH-20-25
	32	IPD/PH-20-32	IPD/PH-20-32	IPD/PH-20-32	IPD/PH-20-32	IPD/PH-20-32



ACCESSORIES

Type	Length (mm)	ø3.5	ø4.0	ø4.5	ø5.0	ø6.0
Clinical RA Shank Handle	16	IPD/MC-00-16	IPD/MC-00-16	IPD/MC-00-16	IPD/MC-00-16	IPD/MC-00-16
Laboratory RA Shank Handle	70	IPD/ML-00-70	IPD/ML-00-70	IPD/ML-00-70	IPD/ML-00-70	IPD/ML-00-70
RA Shank Ratchet	90	IPD/DI-00-90	IPD/DI-00-90	IPD/DI-00-90	IPD/DI-00-90	IPD/DI-00-90
Ratchet adapter		IPD/DI-KA-90	IPD/DI-KA-90	IPD/DI-KA-90	IPD/DI-KA-90	IPD/DI-KA-90

Please see page 210 for more information.



WORKING SYSTEMS

PRODUCT WORKFLOWS DIAGRAM

- CUSTOM TI-BASE
- PSD SYSTEM
- MULTI-UNIT SYSTEM

ACCESSORIES

- SCREWDRIVERS AND KITS

TECHNICAL SPECIFICATIONS

- SCREWS
- TPA SCREWS
- SPECIAL SCREWS

CE MARKING

[RETURN TO INDEX](#)

CUSTOM TI-BASE

WORKFLOW DIAGRAM

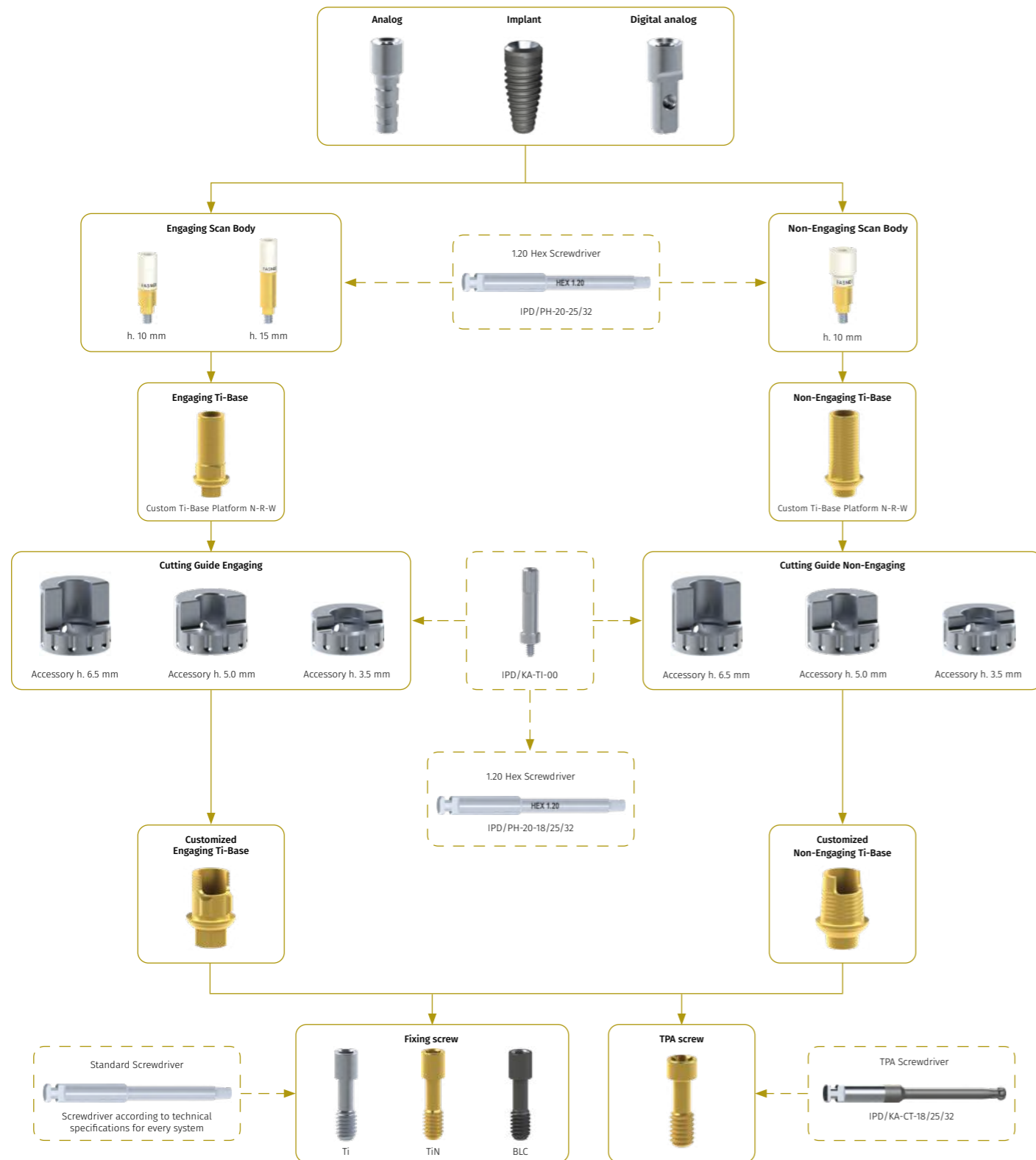

PSD SYSTEM

WORKFLOW DIAGRAM

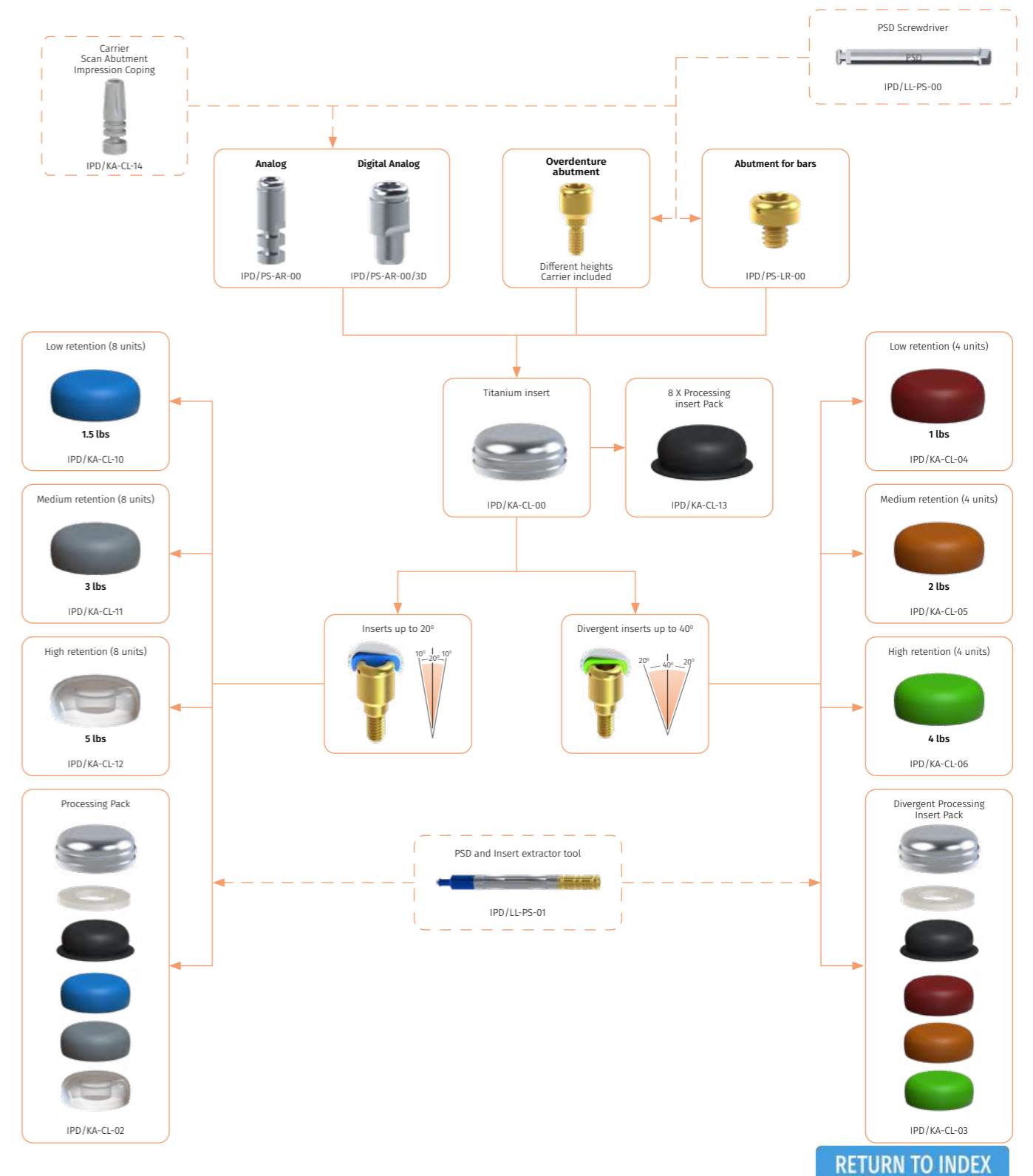

MULTI-UNIT SYSTEM

WORKFLOW DIAGRAM

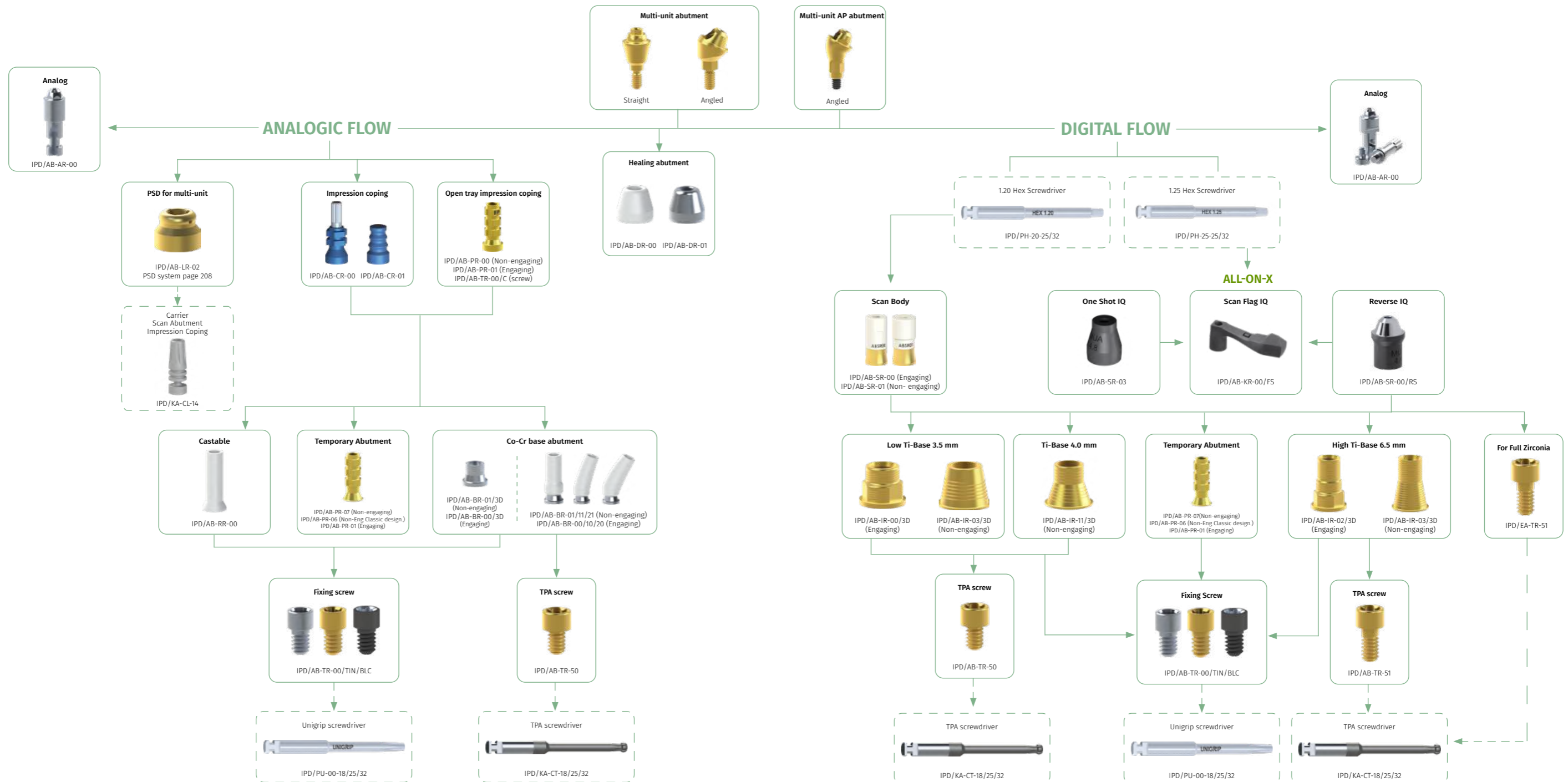

ACCESSORIES

SCREWDRIVERS AND KITS

SCREWDRIVERS

Type	18 mm	25 mm	32 mm
1.00 Hex	IPD/PH-00-18	IPD/PH-00-25	IPD/PH-00-32
1.18 Hex	IPD/PH-18-18	IPD/PH-18-25	IPD/PH-18-32
1.20 Hex	IPD/PH-20-18	IPD/PH-20-25	IPD/PH-20-32
1.25 Hex	IPD/PH-25-18	IPD/PH-25-25	IPD/PH-25-32
1.27 Hex	IPD/PH-27-18	IPD/PH-27-25	IPD/PH-27-32
1.30 Hex	IPD/PH-30-18	IPD/PH-30-25	IPD/PH-30-32
1.40 Hex	IPD/PH-40-18	IPD/PH-40-25	IPD/PH-40-32
1.70 Hex	IPD/PH-70-18	IPD/PH-70-25	IPD/PH-70-32
Type	18 mm	25 mm	32 mm
1.25 Square	IPD/PC-25-18	IPD/PC-25-25	IPD/PC-25-32
Star	IPD/PS-00-18	IPD/PS-00-25	IPD/PS-00-32
Unigrip	IPD/PU-00-18	IPD/PU-00-25	IPD/PU-00-32
Neo GM	IPD/PU-01-18	IPD/PU-01-25	IPD/PU-01-32
Flat	IPD/PP-00-18	IPD/PP-00-25	IPD/PP-00-32
Torx	IPD/PT-00-18	IPD/PT-00-25	IPD/PT-00-32
TPA Screwdriver 	IPD/KA-CT-18	IPD/KA-CT-25	IPD/KA-CT-32



SCREWDRIVERS

Type	20 mm	25 mm	16mm	70 mm	90 mm	-
Multi-Unit Screwdriver	IPD/LL-AB-00	-	-	-	-	-
PSD Screwdriver	-	IPD/LL-PS-00	-	-	-	-
PSD and insert extractor tool	-	-	-	-	-	IPD/LL-PS-01
Clinical RA Shank Handle	-	-	IPD/MC-00-16	-	-	-
Laboratory RA Shank Handle	-	-	-	IPD/ML-00-70	-	-
RA Shank Ratchet	-	-	-	-	IPD/DI-00-90	-
Ratchet Adapter	-	-	-	-	-	IPD/DI-KA-90



ACCESSORIES KITS

		Length	
Kit 1	RA Shank Ratchet 1.20 Hex Screwdriver 1.25 Hex Screwdriver 1.27 Hex Screwdriver 1.70 Hex Screwdriver 1.25 Square Screwdriver Unigrip Screwdriver Flat Screwdriver TPA Screwdriver Torx Screwdriver Multi-unit Screwdriver	18 mm	IPD/KT-DI-18
		25 mm	IPD/KT-DI-25
Kit 1	Clinical RA Shank Handle 1.20 Hex Screwdriver 1.25 Hex Screwdriver 1.27 Hex Screwdriver 1.70 Hex Screwdriver 1.25 Square Screwdriver Unigrip Screwdriver Flat Screwdriver TPA Screwdriver Torx Screwdriver Multi-unit Screwdriver	18 mm	IPD/KT-MC-18
		25 mm	IPD/KT-MC-25
Kit 1	Laboratory RA Shank Handle 1.20 Hex Screwdriver 1.25 Hex Screwdriver 1.27 Hex Screwdriver 1.70 Hex Screwdriver 1.25 Square Screwdriver Unigrip Screwdriver Flat Screwdriver TPA Screwdriver Torx Screwdriver	32 mm	IPD/KT-ML-32



[RETURN TO INDEX](#)

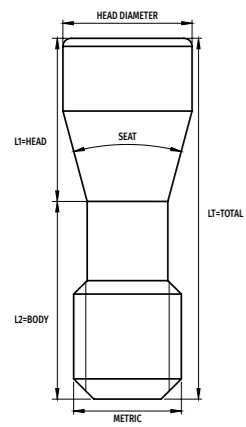

TECHNICAL SPECIFICATIONS

SCREWS

DESCRIPTION

Reference	TIN Reference	Reference /BLC	Compatibility	Platform	Seat	Head diameter	Metric	Head (L1)	Body (L2)	Total (L1)	Screw-driver	Torque (Ncm)
IPD/AA-TN-00	IPD/AA-TN-00/TIN	IPD/AA-TN-00/BLC	Nobel Biocare® Branemark System®	Ø3.5	70°	2.20	M1.6x0.35	2.11	5.19	7.30	Unigrip	35
			Nobel Biocare® Nobel Active®	Ø3.5								
IPD/AA-TR-00	IPD/AA-TR-00/TIN	IPD/AA-TR-00/BLC	Nobel Biocare® Branemark System®	Ø4.1	75°	2.40	M2x0.4	1.50	5.85	7.35	Unigrip	35
			Nobel Biocare® Nobel Active®	Ø4.3								
IPD/AA-TR-01	IPD/AA-TR-01/TIN	IPD/AA-TR-01/BLC	External Hex	Ø4.1	75°	2.50	M2x0.4	1.67	4.60	6.27	1.20 Hex	20
IPD/AA-TR-02	IPD/AA-TR-02/TIN	IPD/AA-TR-02/BLC	Nobel Biocare® Branemark System®	Ø4.1	Flat	2.40	M2x0.4	1.45	5.90	7.35	Unigrip	35
			Nobel Biocare® Nobel Active®	Ø4.3								
IPD/AA-TW-00	IPD/AA-TW-00/TIN	IPD/AA-TW-00/BLC	Nobel Biocare® Branemark System®	Ø5.1	72°	3.40	M2.5x0.45	1.34	5.36	6.70	Unigrip	35
IPD/AA-TW-01	IPD/AA-TW-01/TIN	IPD/AA-TW-01/BLC	Nobel Biocare® Branemark System®	Ø5.1	72°	3.00	M2.5x0.45	1.37	5.33	6.70	Unigrip	35
IPD/AB-TR-00	IPD/AB-TR-00/TIN	IPD/AB-TR-00/BLC	Multi-unit	Ø4.8	Flat	2.00	M1.4x0.3	1.35	2.10	3.45	Unigrip	15
IPD/AC-TN-00	IPD/AC-TN-00/TIN	IPD/AC-TN-00/BLC	Nobel Biocare® Nobel Replace® Select	Ø3.5	Flat	2.35	M1.8x0.35	1.80	6.50	8.30	Unigrip	35
IPD/AC-TR-00	IPD/AC-TR-00/TIN	IPD/AC-TR-00/BLC	Nobel Biocare® Nobel Replace® Select	Ø4.3 / Ø5.0	Flat	2.40	M2x0.4	1.55	8.35	9.90	Unigrip	35
IPD/AD-TT-00	IPD/AD-TT-00/TIN	IPD/AD-TT-00/BLC	Nobel Biocare® Nobel Active®	Ø3.0	70°	1.82	M1.4x0.3	1.81	4.89	6.70	Unigrip	15
IPD/BA-TR-00	IPD/BA-TR-00/TIN	IPD/BA-TR-00/BLC	Biomet® 3i® Externa™ 3i®	Ø3.4 / Ø4.1 / Ø5.0	75°	2.35	M2x0.4	1.79	5.81	7.60	1.20 Hex	25
IPD/BA-TR-01	IPD/BA-TR-01/TIN	IPD/BA-TR-01/BLC	Biomet® 3i® Externa™ 3i®	Ø3.4 / Ø4.1 / Ø5.0	75°	2.35	M2x0.4	1.79	5.81	7.60	1.25 Hex	25
IPD/BA-TR-02	IPD/BA-TR-02/TIN	IPD/BA-TR-02/BLC	Biomet® 3i® Externa™ 3i®	Ø3.4 / Ø4.1 / Ø5.0	Flat	2.40	M2x0.4	1.65	6.15	7.80	1.30 Square	35
IPD/BB-TR-01	IPD/BB-TR-01/TIN	IPD/BB-TR-01/BLC	Biomet® 3i® Certain®	Ø3.4 / Ø4.1 / Ø5.0	Flat	2.00	M1.6x0.35	1.90	6.50	8.40	1.20 Hex	20
IPD/BB-TR-02	-	-	Biomet® 3i® Certain®	Ø3.4 / Ø4.1 / Ø5.0	140°	2.30	M1.6x0.35	2.06	6.34	8.40	1.20 Hex	20
IPD/BC-TR-00	-	-	Biomet® 3i® Low Profile Abutment	Ø4.8	70°	1.95	M1.4x0.3	1.70	2.41	4.11	1.20 Hex	10
IPD/CA-TR-00	IPD/CA-TR-00/TIN	IPD/CA-TR-00/BLC	Klockner® SK2-NK2	Ø4.2	90°	2.45	M1.8x0.35	2.39	3.56	5.95	1.70 Hex	30
IPD/CA-TR-01	IPD/CA-TR-01/TIN	-	Klockner® SK2-NK2	Ø4.2	90°	2.45	M1.8x0.35	0.74	3.56	4.30	Cross	30
IPD/CB-TR-00	IPD/CB-TR-00/TIN	IPD/CB-TR-00/BLC	Klockner® Essential Cone®	Ø4.5	90°	2.35	M1.8x0.35	2.29	4.91	7.20	Star	30
IPD/CD-TN-00	IPD/CD-TN-00/TIN	IPD/CD-TN-00/BLC	Klockner® Vega®	Ø3.5	90°	2.15	M1.6x0.35	2.43	5.57	8.00	Star	30
IPD/CD-TR-00	IPD/CD-TR-00/TIN	IPD/CD-TR-00/BLC	Klockner® Vega®	Ø4.0 - Ø4.5	90°	2.15	Special	2.32	5.68	8.00	Star	30
IPD/DA-TR-00	IPD/DA-TR-00/TIN	IPD/DA-TR-00/BLC	Straumann® Tissue Level (SynOcta® Level)	Ø4.8	90°	2.40	M2x0.4	1.20	3.30	4.50	Torx	15
IPD/DA-TR-01	IPD/DA-TR-01/TIN	IPD/DA-TR-01/BLC	Straumann® Tissue Level (Implant Level)	Ø4.8 / Ø6.5	30°	2.40	M2x0.4	3.03	3.67	6.70	Torx	35
IPD/DA-TR-02	-	-	Straumann® Tissue Level	Ø4.8	Flat	2.52	M2x0.4	1.45	5.90	7.35	Torx	35
IPD/DA-TR-03	IPD/DA-TR-03/TIN	IPD/DA-TR-03/BLC	Straumann® Tissue Level	Ø4.8	30°	2.57	M2x0.4	3.05	3.65	6.70	Torx	35
IPD/DB-TR-00	IPD/DB-TR-00/TIN	IPD/DB-TR-00/BLC	Straumann® Bone Level	Ø3.3 / Ø4.1	30°	2.10	M1.6x0.35	2.31	5.54	7.85	Torx	35
IPD/DC-TR-00	IPD/DC-TR-00/TIN	IPD/DC-TR-00/BLC	Straumann® BLX®	RB/WB	90°	2.10	M1.6x0.35	1.32	4.78	6.10	Torx	30
IPD/DD-TR-00	IPD/DD-TR-00/TIN	IPD/DD-TR-00/BLC	Straumann® SRA®	Ø3.5 / Ø4.6	70°	2.20	M1.4x0.3	1.65	2.00	3.65	Torx	15
IPD/EA-TN-00	IPD/EA-TN-00/TIN	IPD/EA-TN-00/BLC	Astra® OsseoSpeed®	Ø3.0	120°	2.10	M1.4x0.3	2.00	5.50	7.50	1.27 Hex	15
IPD/EA-TR-00	IPD/EA-TR-00/TIN	IPD/EA-TR-00/BLC	Astra® OsseoSpeed®	Ø3.5 - Ø4.0	Flat	2.35	M1.6x0.35	1.95	6.30	8.25	1.27 Hex	20
IPD/EA-TR-01	IPD/EA-TR-01/TIN	IPD/EA-TR-01/BLC	Astra® Cone 20°	Ø3.5-Ø4.0 / Ø4.5-Ø5.0	Flat	2.25	M1.4x0.3	1.85	2.95	4.80	1.27 Hex	15
-	IPD/EA-TR-02/TIN	-	Astra® OsseoSpeed®	Ø3.5 - Ø4.0	Flat	2.15	M1.6x0.35	1.95	6.30	8.25	1.27 Hex	20
IPD/EA-TW-00	IPD/EA-TW-00/TIN	IPD/EA-TW-00/BLC	Astra® OsseoSpeed®	Ø4.5 - Ø5.0	Flat	2.35	M2x0.4	1.90	8.40	10.3	1.27 Hex	25
IPD/EB-TT-00	IPD/EB-TT-00/TIN	IPD/EB-TT-00/BLC	Astra® Evolution®	Ø3.0	52°	2.15	M1.4x0.3	2.40	5.24	7.64	1.27 Hex	25
IPD/EB-TN-00	IPD/EB-TN-00/TIN	IPD/EB-TN-00/BLC	Astra® Evolution®	Ø3.6	60°	2.15	M1.6x0.35	2.12	5.33	7.45	1.27 Hex	25
IPD/EB-TR-00	IPD/EB-TR-00/TIN	IPD/EB-TR-00/BLC	Astra® Evolution®	Ø4.2	100°	2.35	M1.8x0.35	1.92	5.70	7.62	1.27 Hex	25
IPD/EB-TW-00	IPD/EB-TW-00/TIN	IPD/EB-TW-00/BLC	Astra® Evolution®	Ø4.8	Flat	2.35	M2x0.4	1.65	5.95	7.60	1.27 Hex	25
IPD/FA-TR-00	IPD/FA-TR-00/TIN	IPD/FA-TR-00/BLC	Zimmer® Screw Vent®	Ø3.5 / Ø4.5 / Ø5.7	140°	2.10	M1.8x0.35	2.54	5.66	8.20	1.25 Hex	30

TECHNICAL SPECIFICATIONS SCREWS

IPD/FB-TR-00	IPD/FB-TR-00/TIN	IPD/FB-TR-00/BLC	Zimmer® SwissPlus®	Ø4.8	140°	2.30	M2x0.4	2.55	6.75	9.30	1.25 Hex	30
IPD/FB-TR-01	IPD/FB-TR-01/TIN	IPD/FB-TR-01/BLC	Zimmer® SwissPlus®	Ø4.8	30°	2.40	M2x0.4	3.03	3.87	6.90	1.25 Hex	30
IPD/FC-TT-00	IPD/FC-TT-00/TIN	IPD/FC-TT-00/BLC	Zimmer® Eztetic®	Ø3.1	143°	1.96	M1.6x0.35	2.92	5.78	8.70	1.25 Hex	30
IPD/GA-TN-00	IPD/GA-TN-00/TIN	IPD/GA-TN-00/BLC	BTI® External	Ø3.5	Flat	2.35	M2x0.4	1.70	3.85	5.55	1.20 Hex	20
IPD/GA-TW-00	IPD/GA-TW-00/TIN	IPD/GA-TW-00/BLC	BTI® External	Ø5.5	Flat	2.55	M2x0.4	1.70	6.15	7.85	1.20 Hex	20
IPD/GB-TR-00	IPD/GB-TR-00/TIN	IPD/GB-TR-00/BLC	BTI® Internal Universal®	Universal® Ø4.1 / Wide Ø5.5	Flat	2.40	M1.8x0.35	1.85	5.20	7.05	1.20 Hex	35
IPD/GC-TR-01	IPD/GC-TR-01/TIN	IPD/GC-TR-01/BLC	BTI® Multi-im®	Ø4.1	Flat	2.00	M1.4x0.3	1.60	2.11	3.71	1.20 Hex	20
IPD/GD-TN-00	IPD/GD-TN-00/TIN	IPD/GD-TN-00/BLC	BTI® Core	Ø3.5	Flat	2.10	M1.8x0.35	1.82	5.23	7.05	1.20 Hex	35
IPD/HA-TN-00	IPD/HA-TN-00/TIN	IPD/HA-TN-00/BLC	Microdent® Microdent® System	Ø3.5	140°	2.50	M1.8x0.35	2.13	3.87	6.00	1.20 Hex	20
IPD/HA-TR-00	IPD/HA-TR-00/TIN	IPD/HA-TR-00/BLC	Microdent® Microdent® System	Ø4.2 / Ø5.1	120°	2.70	M2x0.4	2.50	5.50	8.00	1.75 Hex	30
IPD/IA-TR-00	IPD/IA-TR-00/TIN	IPD/IA-TR-00/BLC	Dentsply® Xive® Friadent®	Ø3.4 / Ø3.8 / Ø4.5	90°	2.05	M1.6x0.35	2.10	6.75	8.85	1.20 Hex	24
IPD/IB-TR-00	-	-	Dentsply® Ankylos® Balance Base Narrow	C/X	60°	2.40	M1.6x0.35	1.66	3.04	4.70	1.0 Hex	15
IPD/IB-TR-01	-	-	Dentsply® Ankylos®	C/X	60°	2.05	M1.8x0.35	2.01	6.14	8.15	1.0 Hex	25
IPD/ID-TT-00	-	-	Osteoplus® Iridium™ Argentum®	Ø3.3 / Ø3.8 / Ø4.2 / Ø4.8	120°	2.40	M1.8x0.35	1.69	5.83	7.52	1.25 Hex	25
IPD/JA-TR-00	IPD/JA-TR-00/TIN	IPD/JA-TR-00/BLC	Camlog® Camlog® Implant System	Ø3.3 / Ø3.8 / Ø4.3	90°	2.10	M1.6x0.35	2.35	8.10	10.45	1.25 Hex	20
IPD/JA-TX-00	IPD/JA-TX-00/TIN	IPD/JA-TX-00/BLC	Camlog® Camlog® Implant System	Ø5.0	90°	2.50	M2x0.4	2.34	8.11	10.45	1.25 Hex	20
IPD/JB-TR-00	IPD/JB-TR-00/TIN	IPD/JB-TR-00/BLC	Camlog® Conelog® System	Ø3.3 / Ø3.8 / Ø4.3	120°	2.14	M1.6x0.35	1.85	6.86	8.87	1.25 Hex	20
IPD/KA-CI-08	-	-	Hollow Screw	-	Flat	2.80	M2.65x0.3	0.70	1.40	2.10	IPD Cross	10
IPD/LB-TR-00	IPD/LB-TR-00/TIN	IPD/LB-TR-00/BLC	BioHorizons® Tapered Internal	Ø3.0 / Ø3.5 / Ø4.5 / Ø5.7	90°	2.35	M1.8x0.35	2.17	5.08	7.25	1.27 Hex	35
IPD/MA-TN-00	IPD/MA-TN-00/TIN	IPD/MA-TN-00/BLC	Sweden & Martina® Outlink®	Ø3.3	120°	2.20	M1.8x0.35	1.76	5.74	7.50	1.27 Hex	25
IPD/MB-TN-00	IPD/MB-TN-00/TIN	IPD/MB-TN-00/BLC	Sweden & Martina® Premium™ Kohno®	Ø3.3 / Ø3.8	120°	2.20	M1.8x0.35	1.78	6.32	8.10	1.27 Hex	25
IPD/MB-TR-00	IPD/MB-TR-00/TIN	IPD/MB-TR-00/BLC	Sweden & Martina® Premium™ Kohno®	Ø4.25 / Ø5.0	120°	2.40	M2x0.4	1.78	6.00	7.78	1.27 Hex	25
IPD/NA-TN-00	IPD/NA-TN-00/TIN	IPD/NA-TN-00/BLC	Phibo® TSH®	S2	120°	2.23	M1.8x0.35	1.92	6.08	8.00	1.25 Hex	35
IPD/NA-TW-00	-	-	Phibo® TSH®	S5	120°	2.50	M2x0.4	2.50	5.50	8.00	1.25 Hex	35
IPD/OB-TN-00	IPD/OB-TN-00/TIN	IPD/OB-TN-00/BLC	Osstem Implant® TSIII	Ø3.5 M	90°	2.20	M1.6x0.35	2.41	7.79	10.2	1.20 Hex	20
IPD/OB-TR-00	IPD/OB-TR-00/TIN	IPD/OB-TR-00/BLC	Osstem Implant® TSIII	Ø4.0 R	90°	2.30	M2x0.4	2.23	6.12	8.35	1.20 Hex	30
IPD/QB-TR-00	IPD/QB-TR-00/TIN	IPD/QB-TR-00/BLC	Biotech® Dental Kontakt®	RP	90°	1.95	M1.4x0.3	1.80	6.02	7.82	1.20 Hex	20
IPD/RA-TN-00	IPD/RA-TN-00/TIN	IPD/RA-TN-00/BLC	Neodent® Helix® HE	Ø3.3	Flat	1.99	M1.8x0.35	1.90	5.80	7.70	1.20 Hex	32
IPD/RA-TW-00	IPD/RA-TW-00/TIN	IPD/RA-TW-00/BLC	Neodent® Helix® HE	Ø5.0	Flat	2.60	M2.5x0.45	2.10	5.50	7.60	1.20 Hex	32
IPD/RB-TR-00	IPD/RB-TR-00/TIN	IPD/RB-TR-00/BLC	Neodent® Grand Morse® GM	GM	60°	1.86	M1.6x0.35	1.84	7.93	9.77	Neo GM	20
IPD/RC-TR-00	IPD/RC-TR-00/TIN	IPD/RC-TR-00/BLC	Neodent® GM abutment	RP	90°	2.34	M2x0.25	1.53	2.25	3.78	Neo GM	10
IPD/RD-TN-00	IPD/RD-TN-00/TIN	IPD/RD-TN-00/BLC	Neodent® GM micro abutment	Ø3.5	Flat	1.90	M1.4x0.3	1.72	1.99	3.71	Neo GM	10
IPD/SB-TR-00	IPD/SB-TR-00/TIN	IPD/SB-TR-00/BLC	Bego® Semados®	Ø3.25 - Ø3.75 / Ø4.1 / Ø4.5	70°	2.35	M1.8x0.35	2.35	5.25	7.60	1.25 Hex	30
IPD/TA-TT-00	IPD/TA-TT-00/TIN	IPD/TA-TT-00/BLC	MIS® Seven®	Narrow 3.3	120°	2.10	M1.6x0.35	2.53	5.15	7.68	1.25 Hex	30
IPD/TB-TN-00	IPD/TB-TN-00/TIN	IPD/TB-TN-00/BLC	MIS® C1®	Narrow NP	120°	2.10	M1.6x0.35	2.53	5.15	7.68	1.25 Hex	30
IPD/TB-TR-00	IPD/TB-TR-00/TIN	IPD/TB-TR-00/BLC	MIS® C1/V3®	Standard	120°	2.20	UNF 1-72	2.34	5.26	7.60		

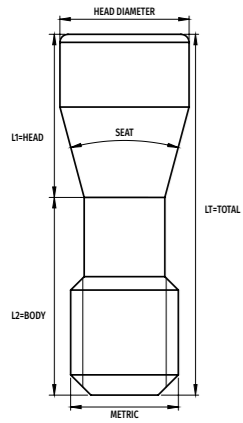

TECHNICAL SPECIFICATIONS

TPA SCREWS

DESCRIPTION		CHARACTERISTIC									
Reference	Compatibility	Platform	Seat	Head diameter	Metric	Head (L1)	Body (L2)	Total (L1+L2)	Screw-driver	Torque (Ncm)	
IPD/AA-TN-50	Nobel Biocare® Branemark System®	Ø3.5	70°	2.30	M1.6x0.35	1.91	4.89	6.80	TPA	20	
	Nobel Biocare® Nobel Active®	Ø3.5									
IPD/AA-TR-50	Nobel Biocare® Branemark System®	Ø4.1	75°	2.25	M2x0.4	1.93	3.87	5.80	TPA	25	
	Sweden & Martina® Outlink®										
	Phibo® TSH®	S3 - S4									
IPD/AA-TR-52	Nobel Biocare® Branemark System®	Ø4.1	Flat	2.30	M2x0.4	1.40	4.40	5.80	TPA	25	
	Biomet® 3i® Externa™ 3i®	Ø3.25 / Ø4.1 / Ø5.1									
	BTI® External	Ø4.1 / Ø5.5									
IPD/AA-TW-50	Nobel Biocare® Branemark System®	Ø5.1	72°	2.85	M2.5x0.45	1.61	4.80	6.41	TPA	25	
IPD/AB-TR-50	Multi-unit	Ø4.8	Flat	2.30	M1.4x0.3	1.50	2.10	3.60	TPA	15	
IPD/AB-TR-51	Multi-unit	Ø4.8	Flat	2.25	M1.4x0.3	3.25	2.10	5.35	TPA	15	
IPD/AC-TN-50	Nobel Biocare® Nobel Replace® Select	Ø3.5	Flat	2.25	M1.8x0.35	1.40	6.10	7.50	TPA	25	
IPD/AC-TN-51	Nobel Biocare® Nobel Replace® Select	Ø3.5	Flat	2.30	M1.6x0.35	1.91	4.89	6.80	TPA	25	
IPD/AC-TR-50	Nobel Biocare® Nobel Replace® Select	Ø4.3 / Ø5.0	Flat	2.30	M2x0.4	1.40	7.40	8.80	TPA	25	
	Astra® OsseoSpeed®	Ø4.5 - Ø5.0									
IPD/AC-TR-51	Nobel Biocare® Nobel Replace® Select	Ø4.3 / Ø5.0	Flat	2.30	M2x0.4	1.30	6.80	8.10	TPA	25	
IPD/AD-TR-50	Nobel Biocare® Nobel Active®	Ø4.3	75°	2.30	M2x0.4	1.96	5.04	7.00	TPA	25	
IPD/AD-TT-50	Nobel Biocare® Nobel Active®	Ø3.0	70°	2.30	M1.4x0.3	1.96	4.69	6.65	TPA	15	
IPD/BB-TR-51	Biomet® 3i® Certain®	Ø3.4 / Ø4.1 / Ø 5.0	Flat	2.30	M1.6x0.35	1.40	6.25	7.65	TPA	20	
IPD/BC-TR-50	Biomet® 3i® Low Profile Abutment	RP Ø4.8	70°	2.30	M1.4x0.3	1.71	2.41	4.12	TPA	15	
IPD/BC-TR-51	Biomet® 3i® Low Profile Abutment	RP Ø 4.8	70°	2.25	M1.4x0.3	1.33	4.24	5.57	TPA	15	
IPD/CA-TR-50	Klockner® SK2-NK2	Ø4.2	90°	2.30	M1.8x0.35	1.50	3.00	4.50	TPA	25	
IPD/CB-TR-50	Klockner® Essential Cone®	Ø4.5	90°	2.30	M1.8x0.35	1.58	4.92	6.50	TPA	20	
IPD/CD-TN-50	Klockner® Vega®	Ø3.5	90°	2.30	M1.6x0.35	1.66	5.69	7.35	TPA	25	
IPD/CD-TR-50	Klockner® Vega®	Ø4.0 / Ø4.5	90°	2.25	Special	1.80	5.65	7.45	TPA	25	
IPD/DA-TR-50	Straumann® Tissue Level (SynOcta® Level)	Ø4.8 / Ø6.5	90°	2.30	M2x0.4	1.65	3.32	4.97	TPA	25	
IPD/DA-TR-51	Straumann® Tissue Level (Implant Level)	Ø4.8 / Ø6.5	30°	2.30	M2x0.4	2.52	3.78	6.30	TPA	25	
IPD/DB-TR-50	Straumann® Bone Level	Ø3.3 / Ø4.1	30°	2.30	M1.6x0.35	2.15	5.55	7.70	TPA	20	
IPD/DD-TR-50	Straumann® SRA®	Ø3.5 / Ø4.6	70°	2.25	M1.4x0.3	1.82	2.09	3.91	TPA	15	
IPD/DE-TR-50	Straumann® TLX®	NT / RT / WT	90°	2.25	M1.6x0.35	1.52	4.78	6.30	TPA		
IPD/EA-TN-50	Astra® OsseoSpeed®	Ø3.0	120°	2.25	M1.4x0.35	1.55	5.55	7.10	TPA	15	
IPD/EA-TR-50	Astra® OsseoSpeed®	Ø3.5-Ø4.0	Flat	2.25	M1.6x0.35	1.35	6.05	7.40	TPA	20	
IPD/EA-TR-51	Astra Uni 20° / 45°	All	Flat	2.30	M1.4x0.3	1.50	2.90	4.40	TPA	15	
IPD/EB-TT-50	Astra® Evolution®	Ø3.0	52°	2.30	M1.4x0.3	1.97	5.24	7.21	TPA	25	
IPD/EB-TN-50	Astra® Evolution®	Ø3.6	60°	2.30	M1.6x0.35	1.84	5.26	7.10	TPA	20	
IPD/EB-TR-50	Astra® Evolution®	Ø4.2	100°	2.30	M1.8x0.35	2.22	5.38	7.60	TPA	25	
IPD/EB-TW-50	Astra® Evolution®	Ø4.8	Flat	2.35	M2x0.4	1.80	6.05	7.85	TPA	25	
IPD/FA-TR-50	Zimmer® Screw Vent®	Ø3.5 / Ø4.5 / Ø5.7	140°	2.25	M1.8x0.35	1.58	5.12	6.70	TPA	25	

IPD/FC-TT-50	Zimmer® Eztetic®	NP Ø3.1	143°	2.30	M1.6x0.35	1.56	5.72	7.28	TPA	20
IPD/GA-TN-50	Bti® External	Ø3.5	Flat	2.30	M2x0.4	1.50	3.60	5.10	TPA	25
IPD/GB-TR-50	Bti® Internal Universal®	Universal® Ø4.1 / Wide Ø5.5	Flat	2.30	M1.8x0.35	1.50	5.00	6.50	TPA	25
IPD/HA-TN-50	Microdent® Microdent® System	Ø3.5	140°	2.30	M1.8x0.35	1.59	4.01	5.60	TPA	25
IPD/HA-TR-50	Microdent® Microdent® System	Ø4.2 / Ø5.1	120°	2.30	M2x0.4	1.72	4.28	6.00	TPA	25
IPD/IA-TR-50	Dentsply® Xive® Friadent®	Ø3.8	90°	2.30	M1.6x0.35	1.56	5.54	7.10	TPA	20
IPD/IB-TR-51	Dentsply® Ankylos®	C/X	60°	2.25	M1.8x0.35	1.89	5.41	7.30	TPA	25
IPD/LB-TR-50	BioHorizons® Tapered Internal	Ø3.0 / Ø3.5 / Ø4.5 / Ø5.7	90°	2.30	M1.8x0.35	1.68	4.82	6.50	TPA	25
	Sweden & Martina® Outlink®	Ø3.3								
IPD/MB-TN-50	Sweden & Martina® Premium™ Kohno®	Ø3.3 / Ø3.8	120°	2.30	M1.8x0.35	1.52	4.88	6.40	TPA	25
	Phibo® TSH®	S2								
IPD/MB-TR-50	Sweden & Martina® Premium™ Kohno®	Ø4.25 / Ø5.0	120°	2.30	M2x0.4	1.55	4.85	6.40	TPA	25
IPD/OB-TN-50	Osttem Implant® TSIII	Ø3.5 M	90°	2.30	M1.6x0.35	1.66	7.74	9.40	TPA	20
IPD/OB-TR-50	Osttem Implant® TSIII	Ø4.0 R	90°	2.30	M2x0.4	1.82	5.68	7.50	TPA	25
IPD/QB-TR-50	Biotech Dental Kontakt®	RP	90°	2.30	M1.4x0.3	1.69	6.06	7.75	TPA	15
IPD/RA-TN-50	Neodent® Helix® HE	Ø3.3	Flat	2.25	M1.8x0.35	1.25	4.85	6.10	TPA	25
IPD/RA-TW-50	Neodent® Helix® HE	Ø5.0	Flat	2.85	M2.5x0.45	0.50	5.40	5.90	TPA	25
IPD/RB-TR-50	Neodent® Grand Morse® GM	GM	60°	2.30	M1.6x0.35	2.08	7.62	9.70	TPA	20
IPD/RC-TR-50	Neodent® GM abutment	Ø4.8	90°	2.34	M2x0.25	1.60	2.23	3.83	TPA	10
IPD/RD-TN-50	Neodent® GM micro abutment	Ø3.5	90°	2.25	M1.4x0.3	1.40	1.99	3.39	TPA	10
IPD/SB-TR-50	Bego® Semados®	Ø3.25-Ø3.75 / Ø4.1 / Ø4.5	70°	2.30	M1.8x0.35	1.95	4.95	6.90	TPA	25
IPD/TA-TT-50	MIS® Seven®	Narrow 3.3	120°	2.30	M1.6x0.35	1.53	4.92	6.45	TPA	20
IPD/TB-TN-50	MIS® C1®	Narrow NP	120°	2.25	M1.6x0.35	1.55	5.00	6.55	TPA	20
IPD/TB-TR-50	MIS® C1/V3®	Standard	120°	2.25	UNF 1-72	2.27	4.98	7.25	TPA	25
IPD/UB-TN-50	DIO® UFII	NP	90°	2.30	M1.4x0.3	1.71	5.34	7.05	TPA	15
IPD/UB-TR-50	DIO® UFII	RP	120°	2.30	M2x0.4	1.80	6.20	8.00	TPA	25
IPD/WA-TR-50	Megagen® AnyOne®	RP	120°	2.30	M2x0.4	1.81	8.02	9.83	TPA	25
IPD/XA-TR-50	Dentium® Implantium® /Superline®	RP	120°	2.30	M2x0.4	1.81	8.02	9.83	TPA	25
IPD/YB-TR-50	Medentis® ICX	RP	30°	2.30	M1.6x0.35	3.15	5.10	8.25	TPA	20
IPD/3A-TR-50	Galimplant® Multi-Position Aesthetic	Ø4.0	140°	2.50	M2x0.4	1.50	2.65	4.15	TPA	25
IPD/3A-TR-51	Galimplant® Multi-Posición Estético	Ø4.0	140°	2.50	M2x0.4	3.85	2.65	6.50	TPA	25

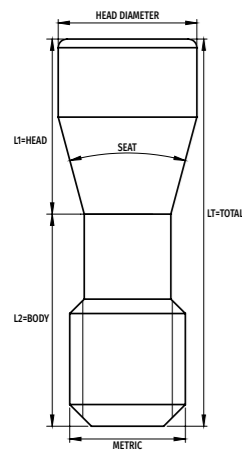

TECHNICAL SPECIFICATIONS

SPECIAL SCREWS IPDMILLED

DESCRIPTION

CHARACTERISTIC

Reference	TIN Reference	Reference /BLC	Compatibility	Platform	Seat	Head diameter	Metric	Head (L1)	Body (L2)	Total (L1)	Screw-driver	Torque (Ncm)
IPD/DA-TR-01/X	-	-	Straumann® Tissue Level*	RN Ø4.8	30°	2.5	M2x0.4	2.30	3.70	7.00	Torx	35
IPD/EB-TR-00/X	-	-	Astra® Evolution*	M Ø4.2	78°	2.35	M1.8x0.35	1.94	5.66	7.60	1.27 Hex	25
-	IPD/EA-TR-02/TIN	-	Astra® OsseoSpeed*	Aqua Ø3.5 - Ø4.0	Flat	2.15	M1.6x0.35	1.95	6.30	8.25	1.27 Hex	20
IPD/AD-TN-00/X	-	-	Nobel Biocare® Active*	Ø3.0	Flat	2.25	M1.6x0.35	1.80	5.90	7.70	Unigrip	35
IPD/AD-TR-00/X	-	-	Nobel Biocare® Active*	Ø4.3	Flat	2.5	M2x0.4	1.85	6.15	8.00	Unigrip	35
IPD/IA-TR-00/X	-	-	Dentsply® Xive® Friadent*	Ø3.8	90°	2.1	M1.6x0.35	2.00	6.30	8.30	1.20 Hex	24
IPD/IB-TR-01/X	-	-	Dentsply® Ankylos®	C/X	30°	2.4	M1.8x0.35	3.10	6.50	9.60	1.0 Hex	25
IPD/IB-TW-00	-	-	Camlog® Conelog®	Ø5.0	120°	2.5	M2x0.4	2.06	6.84	8.90	1.25 Hex	20
IPD/TA-TR-00/X	-	-	MiS® Seven®	Wide WP	120°	2.2	M1.8x0.35	2.40	5.20	7.60	1.27 Hex	30

CE MARKING

WARNING: This product catalogue may contain some trade names that differ from the descriptions used for the models. These synonyms have been used for practical and commercial reasons and/or due to the use of terms/categories that are widely used and recognised by the market.

CE MARKING OF CONFORMITY (01)	FAMILIES	MODELS	DESCRIPTION OF THE MODELS
CE	Laboratory instruments and accessories from <i>ipd</i>	AN	Analog
		AND3D	Digital Analog
		CA	Castable
		AINC3D	Cutting guide
		TI	Coping
		TTI	Coping Screw
		SCTR	Scan Transfer
		SC3D	Scan Abutment
		SC	Scan Abutment CoCr
		SCH	Scan abutment Hollow
		LL	Screwdrivers
		STD3D	Stump Die 3D
		SCOS	One Shot IQ
		SCFL	Scan Flag IQ
		SCLQ	ScanLogIQ® Kit
CE 0051	Attachments and accessories	PC	Cementing Abutment
		PP	Temporary abutment
		PMR	Straight Multi-Unit Abutment
		PMA	Angled Multi-Unit Abutment
		IN	Hollow Screw System
		INC3D	Custom Interface System
		INSI	Cerec® Ti Base
		PSD	PSD Overdenture Abutment
		TC	Healing Abutment
		CCB3D	Co-Cr base with castable
		CCR	Straight Co-Cr base with castable
		CCA	Angled Co-Cr base with castable
		PREM	IPDmilled Blanks
		TT	Titanium Screws
		TPA	TPA Screws
TTN	TIN Screws		
TTC	BLC Screws		
APSD	PSD Retentive inserts		
CE 0425	IPDmilled Type A System		Premilled Blank Ti

Information note - 01: The IPD medical devices included in this catalogue comply with the applicable requirements of EU Regulation 2017/745 and bear the CE conformity marking. If you would like to receive more information about our products, please do not hesitate to contact IPD customerservice@ipd2004.com

Information note - 02: The IPDmilled Type A system is distributed by IPD, conformity assessment is carried out by NB (0425).

All trademarks and other distinctive signs, designs, patents, text, photographs, graphics or other creations of IPD are the exclusive property of Implant Prótesis Dental 2004 S.L. and are duly protected by legislation on intellectual property. Therefore, any use, reproduction or other form of exploitation of the exclusive rights of IPD requires prior written consent. Trademarks and other signs of third parties used by IPD must be used with identification of the owner and in a manner that does not give the appearance of a commercial link. The use of IPD products must be in accordance with IPD's instructions to ensure compliance with all procedures involved in the use of the product and in accordance with generally accepted good dental practice.

IPD AROUND

THE WORLD



INTELLIGENT
PROSTHETIC
DENTISTRY